

MeetingBar A20/A30 Teams[®] Collaboration Bar User Guide



Contents

About This Guide.....	5
Related Documentations.....	5
Summary of Changes.....	5
Changes for Guide Version 15.80.....	5
Changes for Guide Version 15.68.....	5
Changes for Guide Version 15.60.....	5
Changes for Guide Version 15.52.....	6
Getting Started.....	6
Hardware of MeetingBar A20.....	6
Front Panel of MeetingBar A20.....	7
Rear Panel of MeetingBar A20.....	7
Hardware of MeetingBar A30.....	8
Front Panel of MeetingBar A30.....	8
Rear Panel of MeetingBar A30.....	9
LED Instructions of Devices.....	9
The Home Screen.....	10
Interactive Mode.....	11
Touch Control.....	12
Remote Control.....	12
Waking the System.....	13
Signing into Microsoft Teams.....	13
Signing into Your Device.....	13
Signing into Microsoft Teams on Your Device.....	14
Signing into Microsoft Teams via Web Sign-in.....	15
Signing out of Your Device.....	15
Meeting.....	15
Creating a Meeting.....	16
Joining a Meeting.....	16
One-button/One-touch Join.....	16
Call Meeting Number Join.....	16
Proximity Join.....	17
Joining a Scheduled Meeting.....	19
Managing a Meeting.....	20
Adding Participants.....	20
Removing a Participant.....	20
Managing Audio.....	20
Managing Video.....	21
Recording a Meeting.....	22
Sharing Whiteboard.....	22
Introduction of the Whiteboard.....	22
Using and Viewing the Whiteboard.....	23
Dual Screen Touch.....	24
Raising Hand.....	24

Setting the Screen Layout.....	24
Turning on Live Captions.....	24
Leaving a Meeting.....	24
Sharing Content.....	25
Sharing Content with VCH51 Video Conferencing Hub.....	25
Using WPP20 Wireless Presentation Pod.....	25
Sharing Content via WPP20.....	25
Switching the Shared Content via WPP20.....	26
Stopping Sharing Content via WPP20.....	26
Dual Screen Display.....	26
Camera Settings.....	26
Controlling Camera Position.....	27
Configuring the Exposure Settings.....	27
Configuring the White Balance Setting.....	28
Adjusting Display Image of the Camera.....	28
Enabling Auto-framing for Camera.....	28
Enabling Speaker-tracking for Camera.....	29
PiP Mode.....	29
Multi-focus Framing.....	29
Enabling Small FoV Mode for Camera.....	30
Camera Pan Direction.....	30
Resetting the Camera.....	30
Teams Device Settings.....	30
Changing the Backlight Time.....	31
Audio Settings.....	31
Setting Audio Input/Output Device.....	31
Bluetooth.....	31
Activating or Deactivating the Bluetooth Mode.....	31
Enabling/Disabling Your Device Discovery.....	32
Disconnecting the Bluetooth Device.....	32
Wireless Network.....	32
Activating or Deactivating the Wi-Fi Mode.....	32
Connecting to the Wireless Network.....	32
Viewing the Wireless Network Information.....	33
Disconnecting the Wireless Network Connection.....	33
Accessibility Features.....	34
Large Text.....	34
High Contrast Mode.....	34
Color Correction.....	34
Getting More Information About Microsoft Teams.....	34
Viewing More Information About Microsoft Teams.....	35
Company Portal.....	35
Sending Feedback.....	35
Maintaining Teams Devices.....	35

Rebooting Your Device.....	36
Viewing Device Status.....	36
Resetting Your Device.....	36

Troubleshooting..... 36

Why does the device display “Network unavailable”?.....	37
Why do the device display time and date incorrectly?.....	37
How can I obtain the MAC address when the device is not powered on?.....	37
How can I switch to Teams edition?.....	37
Checking the IP Address of Device.....	37

About This Guide

Thank you for choosing Yealink MeetingBar A20/A30 video collaboration bar, which is mainly designed to work with the Microsoft Teams client. This guide provides everything you need to use your new device quickly. Firstly, verify with your system administrator that the IP network is ready for device configuration. Also, be sure to read the Quick Start Guide in the product package.

- [Related Documentations](#)
- [Summary of Changes](#)

Related Documentations

You can find the following types of documents from each product support page on [Yealink Support](#):

- Release Notes: This guide describes what's new for a new device firmware.
- Quick Start Guide: This guide describes the contents of your package, and how to assemble the device or accessory. This guide is also included in your device package.
- Administrator Guide: This guide provides detailed information about setting up your network and configuring features.

Summary of Changes

- [Changes for Guide Version 15.80](#)
- [Changes for Guide Version 15.68](#)
- [Changes for Guide Version 15.60](#)
- [Changes for Guide Version 15.52](#)

Changes for Guide Version 15.80

The following sections are new for this version:

- [Dual Screen Touch](#)
- [PiP Mode](#)
- [Multi-focus Framing](#)

Major updates have occurred to the following section:

- [Dual Screen Display](#)

Changes for Guide Version 15.68

The following sections are new for this version:

- [Enabling Small FoV Mode for Camera](#)

Changes for Guide Version 15.60

The following sections are new for this version:

- [Sharing Content](#)
- [Dual Screen Display](#)

Major updates have occurred to the following sections:

- Due to Teams APP is updated, the interface displayed on the device has changed.
- [Signing into Microsoft Teams](#)
- [Audio Settings](#)

Changes for Guide Version 15.52

MeetingBar A30 is new to this guide.

The following sections are new for this version:

- [Hardware of MeetingBar A30](#)
- [Recording a meeting](#)
- [Sharing Whiteboard](#)
- [Raising Hand](#)
- [Setting Screen Layout](#)
- [Turning on Live Captions](#)
- [Audio Settings](#)

Major updates have occurred to the following sections:

- Due to Teams APP is updated, the interface displayed on the device has changed.
- [LED Instructions of Devices](#)
- [Configuring the Exposure Settings](#)
- [Configuring the White Balance Setting](#)
- [Adjusting Display Image of the Camera](#)
- [Camera Pan Direction](#)

The following features are be cancelled:

- Screen savers.
- The requirement to import the license from the Zoom Rooms version upgrade to the Teams version.

Getting Started

This chapter aims to make you familiar with the device.



Note: As you read this guide, remember that some features are configurable by your system administrator or determined by your device environment. As a result, some features may not be enabled or operated differently on your device. Additionally, the examples and graphics in this guide may not directly reflect what is displayed or is available on your device.

- [Hardware of MeetingBar A20](#)
- [Hardware of MeetingBar A30](#)
- [LED Instructions of Devices](#)
- [The Home Screen](#)
- [Interactive Mode](#)
- [Waking the System](#)

Hardware of MeetingBar A20

- [Front Panel of MeetingBar A20](#)
- [Rear Panel of MeetingBar A20](#)

Front Panel of MeetingBar A20

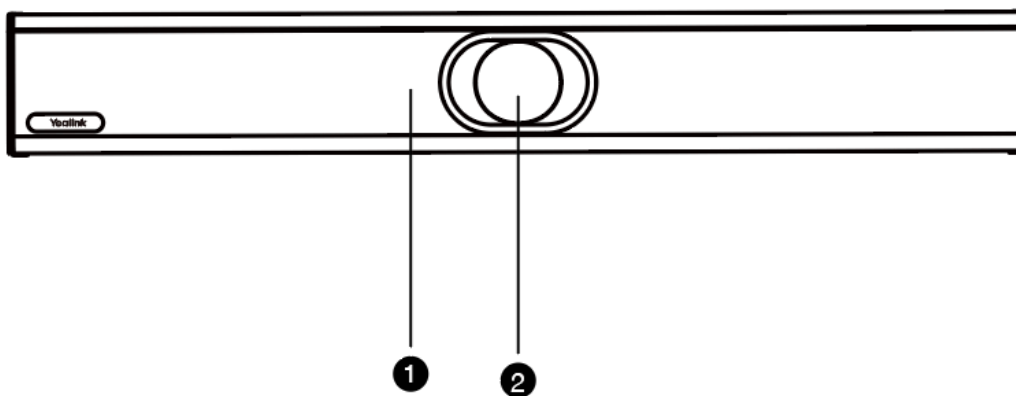

No.	Item	Description
1	LED Indicator	Indicates the device status.
2	Camera	Camera with an electric privacy shutter.

Related information

[LED Instructions of Devices](#)

Rear Panel of MeetingBar A20

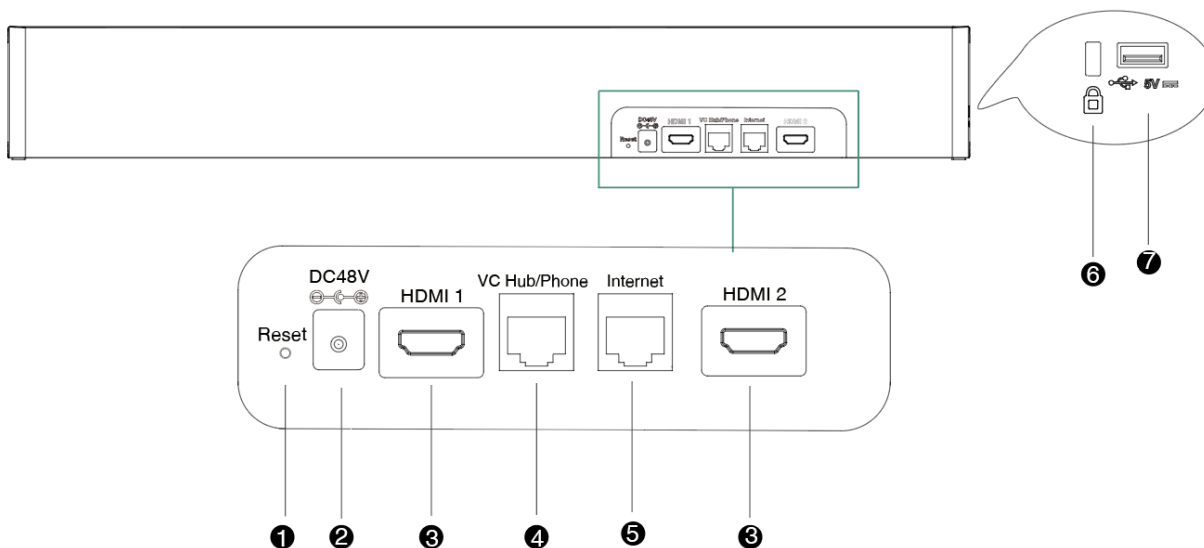

No.	Port Name	Description
1	Reset Key	Reset the MeetingBar A20 device to factory defaults.

No.	Port Name	Description
2	DC48V	Connect to the power source via a power adapter.
3	HDMI	Connect to a monitor for video images output.
4	VC Hub/ Phone	<ul style="list-style-type: none"> If you want to use wired sharing to present, connect this port to the PoE port on the VCH51 video conferencing hub.
5	Internet	Connect to the network device.
6	Security Slot	Allow you to connect a universal security cable to the device, so you can lock the device down. The device cannot be removed when locked.
7	USB	Allow you to connect the USB accessories.

Hardware of MeetingBar A30

- [Front Panel of MeetingBar A30](#)
- [Rear Panel of MeetingBar A30](#)

Front Panel of MeetingBar A30

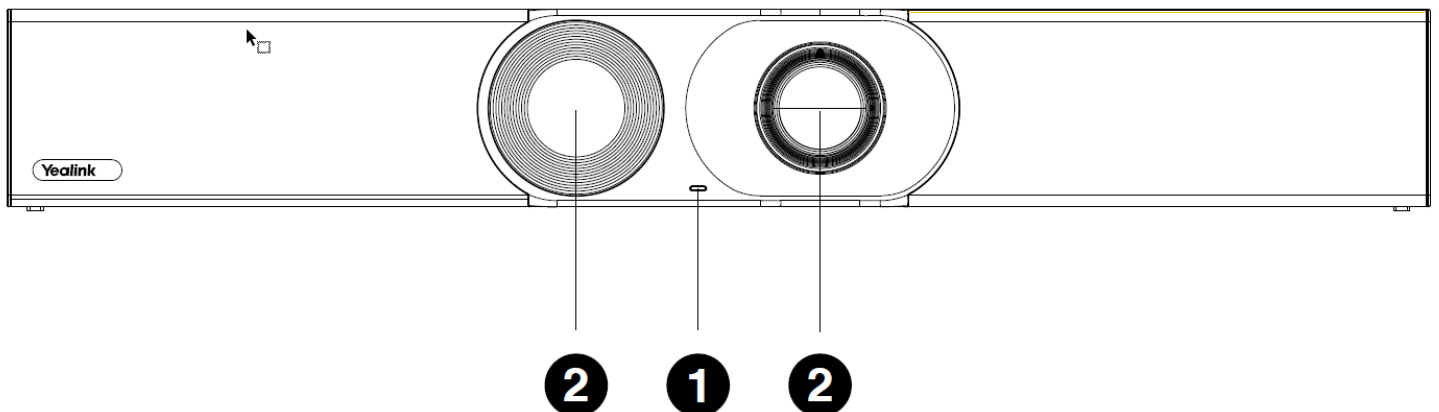

No.	Item	Description
1	LED Indicator	Indicates the device status.
2	Camera	Camera with an electric privacy shutter.

Related information

[LED Instructions of Devices](#)

Rear Panel of MeetingBar A30

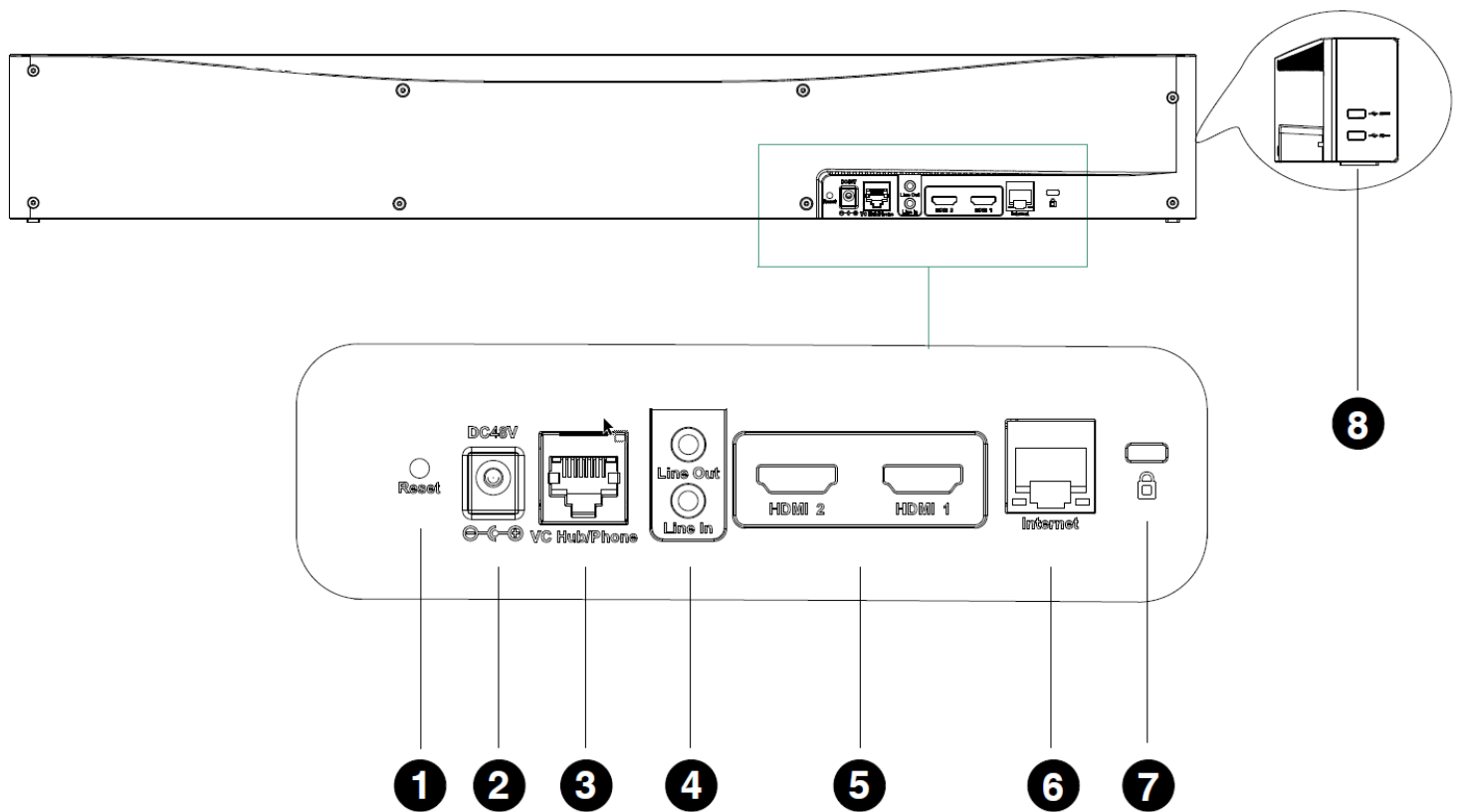

No.	Port Name	Description
1	Reset Key	Reset the MeetingBar A30 device to factory defaults.
2	DC48V	Connect to the power source via a power adapter.
3	VC Hub/Phone	<ul style="list-style-type: none"> If you want to use wired sharing to present, connect this port to the PoE port on the VCH51 video conferencing hub.
4	Line Out/Line in	Connect to an audio output/input device via an audio cable (3.5 mm).
5	HDMI	Connect to a monitor for video images output.
6	Internet	Connect to the network device.
7	Security Slot	Allow you to connect a universal security cable to the device, so you can lock the device down. The device cannot be removed when locked.
8	USB	Allow you to connect the USB accessories.

LED Instructions of Devices

LED Status	Description
Off	The device is powered off, or is not connected to the power adapter.

LED Status	Description
Solid green	The device is initializing. The device is working (calling/sharing content).
Flashing green	There is an incoming call.
Solid red	The device is muted.
Solid orange	The device is idle.
Flashing orange	The device is upgrading firmware.

 **Note:** You can configure backlight time for the device. The device goes to the sleep mode after the designated time.

Related tasks

[Changing the Backlight Time](#)

The Home Screen

If the system has a Teams account logged in, the monitor idle screen is shown as below:



If you have scheduled meetings, the monitor idle screen is shown as below:



No.	Item	Description
1	Time	The current time of the system.
2	Profile	The current account name and account number.
3	More	Configure the video conferencing device.
4	Meet now	Initiate a Meet Now conference at any time, without any reservation.
5	Call	Join the meeting by calling a meeting number.
6	Share	Click to share the content.
7	Schedule	When you log into your Teams account, you can view the conference schedule. In the example: Meeting theme: A20 Demo Test Meeting time: 11:00 AM - 6:30 PM Moderator: Zhang teamstest

Interactive Mode

If you connect a touch display device, you can operate the Meetingbar A20/A30 either by remote control or touch control. If you connect a non-touch display device, you can use the remote control, mouse, or CTP18.

 **Note:** For more information about how to use CTP18 control the device, please refer to [Yealink Teams CTP18 Collaboration Touch Panel User Guide \(For MeetingBar A20&A30\)](#).

- [Touch Control](#)
- [Remote Control](#)

Touch Control



Touch Monitor

Remote Control

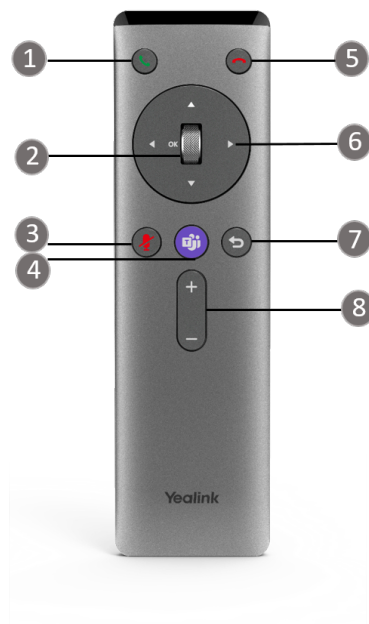

Remote Controller

The following table introduces the keys on the remote control:

No.	Name	Description
1	Answer Key	Press to answer a call.

No.	Name	Description
2	Scroll Wheel/OK Key	<ul style="list-style-type: none"> • Scroll up to increase the focal length of the camera. • Scroll down to decrease the focal length of the camera. • Press to confirm the action.
3	Mute Key	Press to mute or unmute the microphone.
4	Teams Key	Press to join a meeting.
5	End Call Key	Press to leave a meeting.
6	Navigation Key	Navigate through menu items.
7	Back Key	Press to return to the previous menu.
8	Volume Up/Down Key	Press to increase/decrease the volume.

Waking the System

Procedure

Do one of the following:

- Press any keys on your remote control to wake up the device.
- Tap the touch monitor screen to wake up the device.



Note: If your monitor with CEC, the device wakes up automatically when you near the device.

Signing into Microsoft Teams

You can sign into the device with your Microsoft online account.

- [Signing into Your Device](#)
- [Signing out of Your Device](#)

Signing into Your Device

You can sign into your Microsoft online account directly on your device or sign into your device via a web sign-in, including your sign-in address and password.

About this task

Contact your system administrator to get your sign-in account.



Note: We recommend that you sign in via the web.

- [Signing into Microsoft Teams on Your Device](#)
- [Signing into Microsoft Teams via Web Sign-in](#)

Signing into Microsoft Teams on Your Device

Procedure

1. Select **Sign in on this device**.

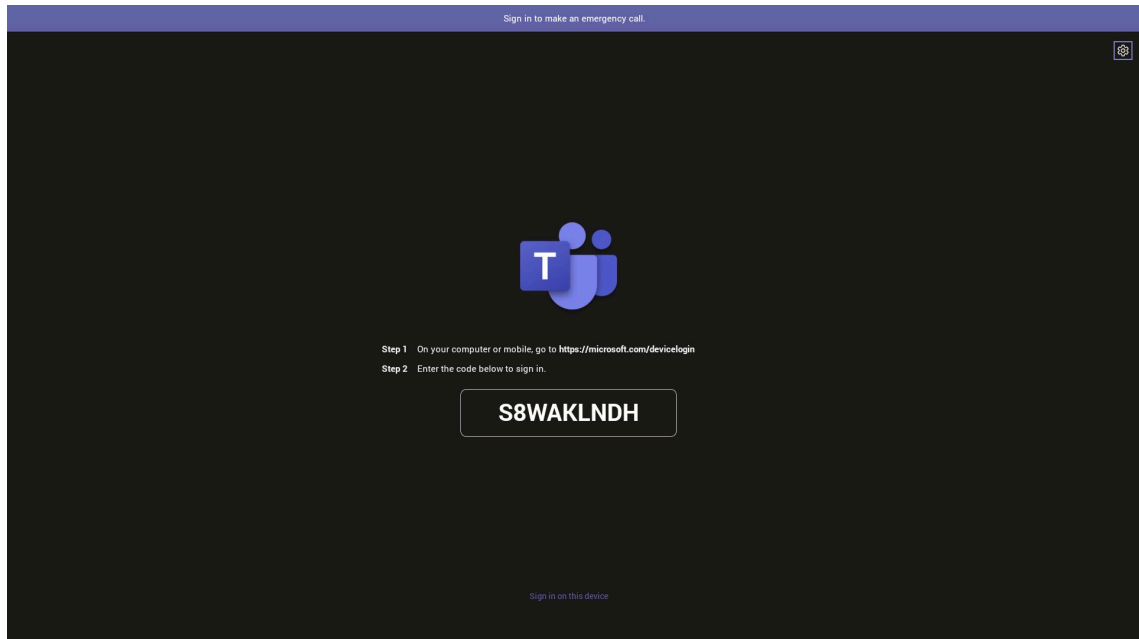

2. Enter your user credentials and select **sign in**.
You will be connected to the Company Portal automatically.

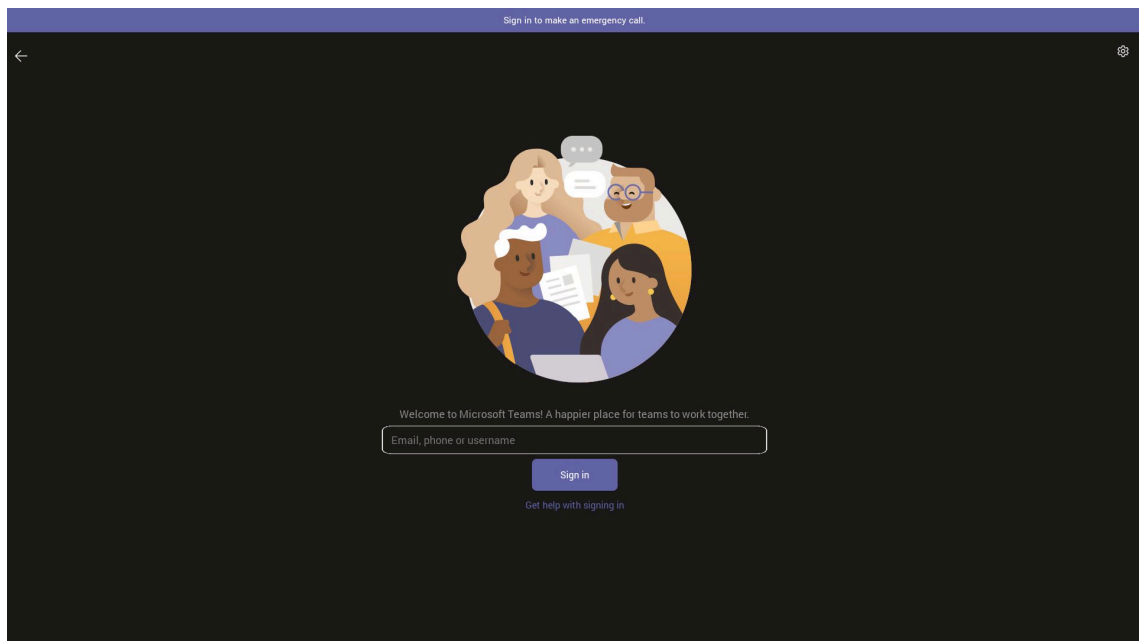

3. Enter your password and select **Sign in**.
4. After the device signs in successfully, select **Got it**.

Signing into Microsoft Teams via Web Sign-in

Procedure

1. Go to <https://microsoft.com/devicelogin> on your computer or mobile.
2. Enter the code shown on your device and select **Next**.
3. Enter your user credentials or select the desired account to sign in.

After you successfully sign into Microsoft Intune Company Portal, a confirmation message is displayed.

Signing out of Your Device

Procedure

1. Go to **More > Settings > Sign out**.
2. Select **OK**.

Meeting

Teams meetings are a great way to come together with your colleagues and clients both inside and outside of your organization. You can initiate meetings, view scheduled meetings, join meetings, and manage meetings.

- [Creating a Meeting](#)
- [Joining a Meeting](#)
- [Managing a Meeting](#)
- [Recording a Meeting](#)
- [Sharing Whiteboard](#)
- [Raising Hand](#)
- [Setting the Screen Layout](#)
- [Turning on Live Captions](#)
- [Leaving a Meeting](#)

Creating a Meeting

When you register a Teams account, you can initiate a meet now conference at any time, without any reservation.

Procedure

1. Select **Meet now**.

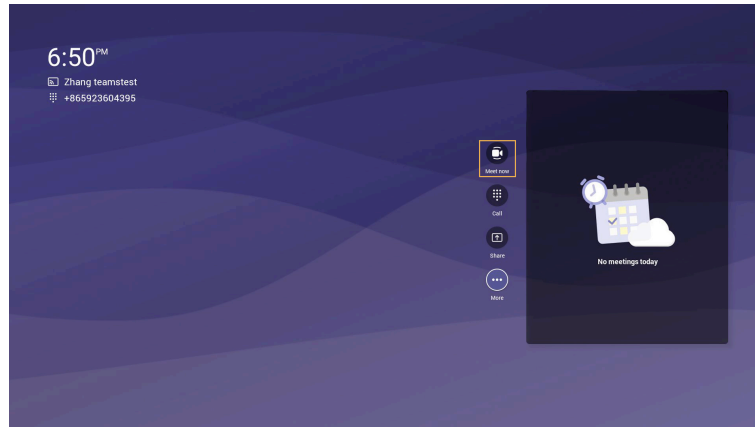

2. Enter the participant account information to search and then select the desired participant.
3. Select **Start meeting**.

Joining a Meeting

- [One-button/One-touch Join](#)
- [Call Meeting Number Join](#)
- [Proximity Join](#)
- [Joining a Scheduled Meeting](#)

One-button/One-touch Join

You can join a Teams meeting scheduled on the Teams phone, the Teams client, or the Outlook.

Procedure

- Select **Join** to join the scheduled meeting.
- On your remote control/CP900/CP700, press the Teams button .

 **Note:** You can join the meeting by CP900/CP700 only if you are using a USB connection.

Call Meeting Number Join

You can join the meeting by calling a meeting number.

Before you begin

The calling plan has been configured for your Teams account.

Procedure

1. Select **Call**.

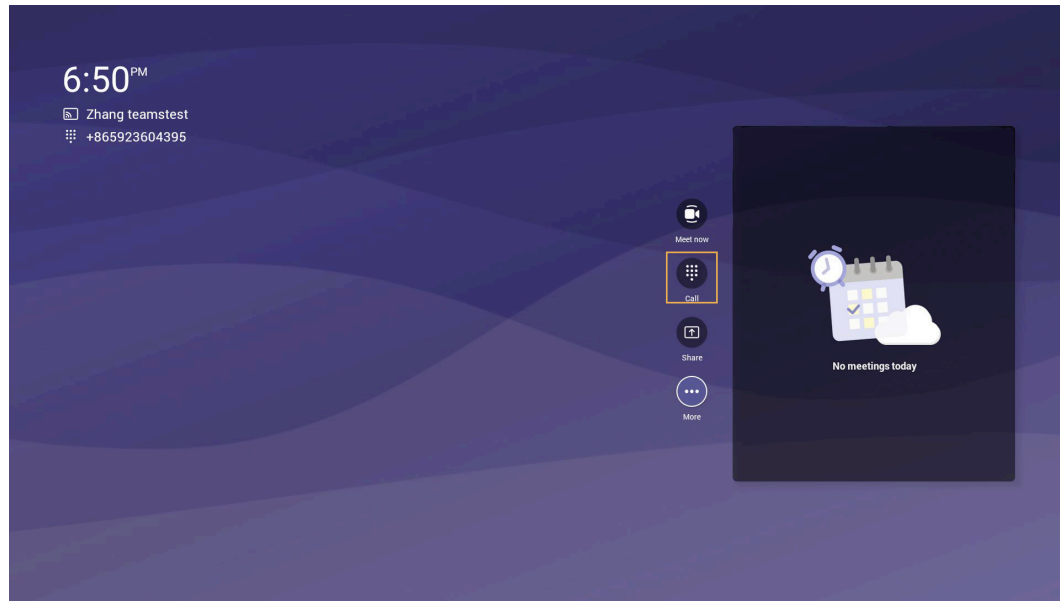

2. Enter the meeting number and dial out.

Proximity Join

You can move a Teams meeting on your mobile phone or laptop to the nearby device by the option of **Add a room**.

Before you begin

Make sure the Bluetooth mode is activated and **More > Proximity join** is enabled.

Procedure

1. Before starting a meeting, do one of the following:

On the mobile phone: go to **Join now** > **Join and add a room** and select the desired device.

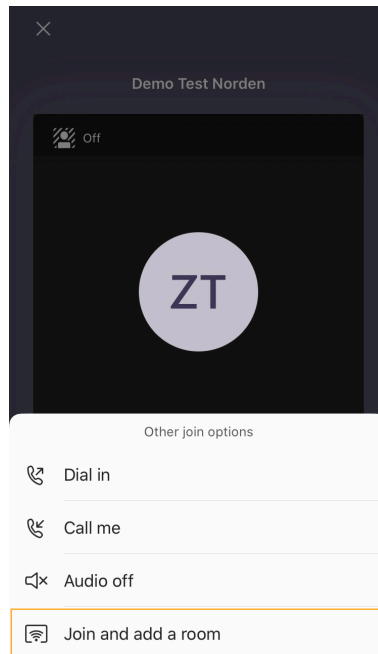

On the laptop: select **Room audio (suggested)** > **Join now**.

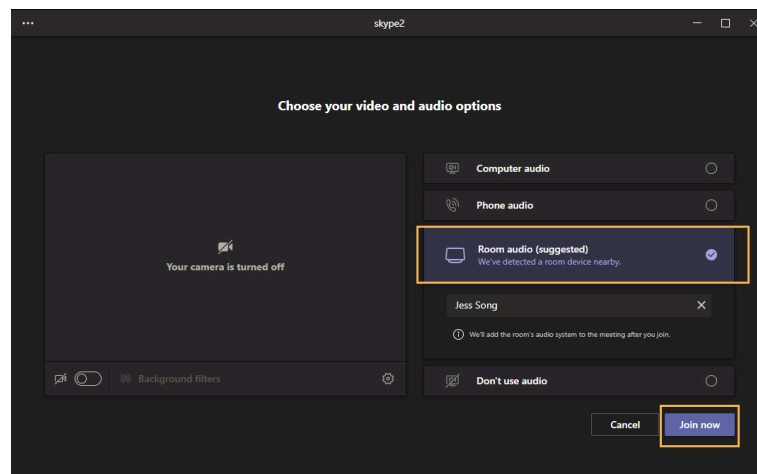

- During a meeting, go to  > **Add a room** and select the desired device on the mobile phone.

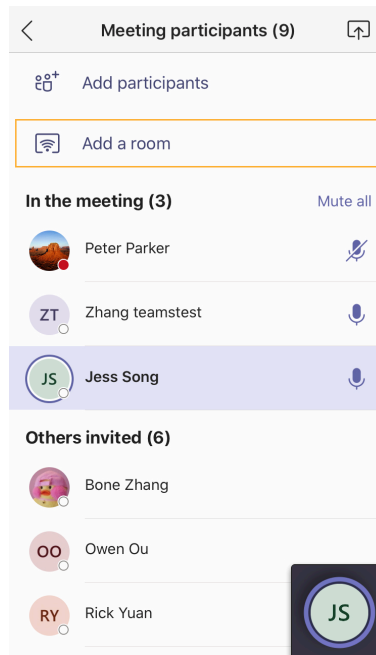

Related tasks

[Activating or Deactivating the Bluetooth Mode](#)

Joining a Scheduled Meeting

If you have scheduled meetings or are invited to a scheduled meeting, the meeting schedule will be displayed on your device. You can select the desired one to join.

Before you begin

The device synchronizes the meeting information from the server every 5 minutes. The device only displays meeting information within the last 10 minutes.

Procedure

- On the idle screen:
 - Press the navigation key to view the upcoming meetings of today.

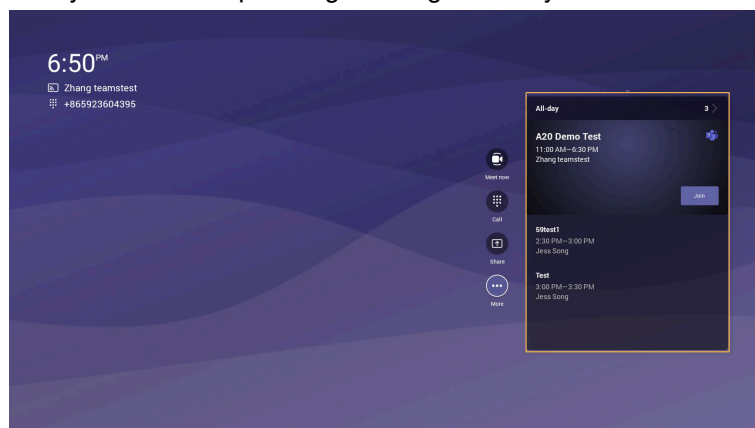

- Select **All-day** to view all-day meeting.
- Select **Join** to join the meeting.

Managing a Meeting

You can manage meetings in the following ways:

- [Adding Participants](#)
- [Removing a Participant](#)
- [Managing Audio](#)
- [Managing Video](#)



Adding Participants

Before you begin

To use the dialpad to add a participant, make sure the calling plan has been configured for your Teams account.

Procedure

During the meeting, do one of the following:

- Select  and select .
Enter the participant account information to search and then add the participant.
- Select  > **Dial pad**.
Dial out a number to add the participant.

Removing a Participant

You can remove participants, and the meeting continues.

Procedure

1. Select  to view the participants list.
2. Select the desired participant and select **Remove from meeting** to remove the participant.

Managing Audio



- [Muting/Unmuting the Microphone](#)
- [Muting a Participant](#)
- [Adjusting the Volume](#)

Muting/Unmuting the Microphone

You can mute/unmute the microphone during the meeting.

Procedure

During the meeting, do one of the following:

- Select  /  to mute/unmute the microphone.
- On your remote control, press the mute key.
- On your CP900/CP700, tap the mute key .

 **Note:** You can mute/unmute the microphone by CP900/CP700 only if you are using a USB connection.

Muting a Participant

You can mute a participant as needed.

Procedure

1. Select  to view the participants list.
2. Select the desired participant and select **Mute participant**.

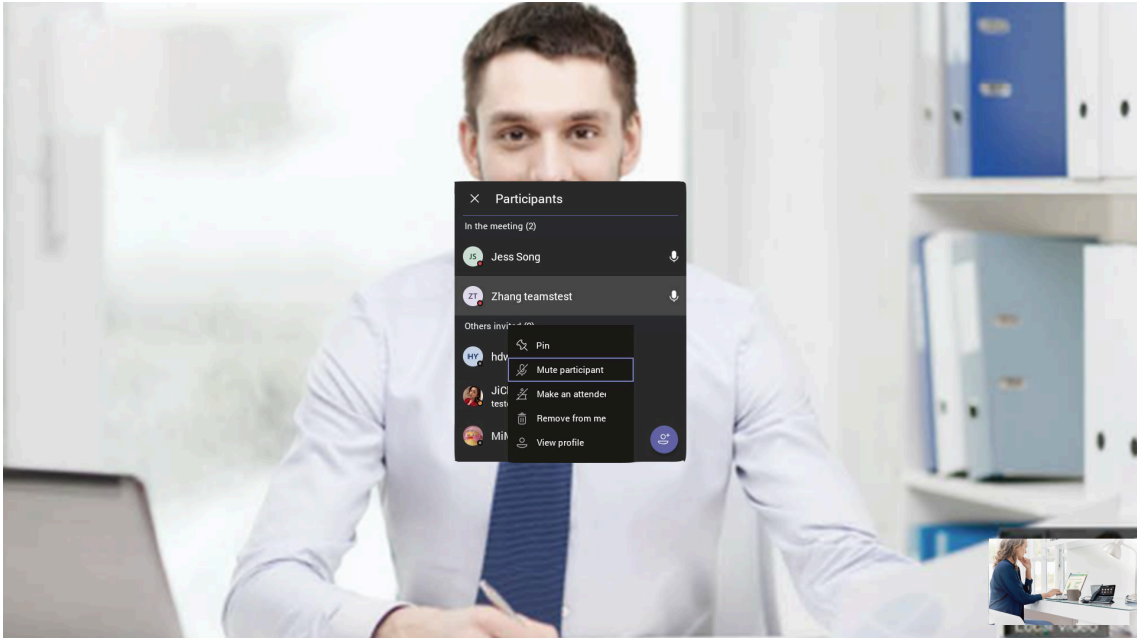





Adjusting the Volume

You can adjust the speaker volume.

Procedure

Do one of the following:

- Select  /  to adjust volume.
- On the remote control, press the Volume Down/Up key to adjust volume.
- On your CP900/CP700, tap  /  to adjust volume.

 **Note:** You can adjust volume by CP900/CP700 only if you are using a USB connection.



Managing Video

- [Turning off/on the Local Camera](#)
- [Turning off/on Incoming Video](#)

Turning off/on the Local Camera



You can turn off/on your camera during the meeting.

Procedure

Select  /  to turn the camera off or on.

Turning off/on Incoming Video

Procedure

1. Select  > **Turn off incoming video** to stop streaming the participant's video.
2. To view the participant's video, select  > **Turn on incoming video**.

Recording a Meeting

Any Teams meeting can be recorded to capture audio and video. The recording happens in the cloud, and it is saved so you can share it securely across your organization.

About this task



Note: Whiteboards are not currently captured in meeting recordings.

Procedure

During a more than two people meeting, select  > **Start recording** to record a meeting.

To stop recording, select  > **Stop recording**.

Sharing Whiteboard

Whiteboard integration in Microsoft Teams meetings is powered by whiteboard for the web, which lets participants of Teams meetings collaborate together on a shared digital canvas. You can share a whiteboard to make it available to all participants in a Teams meeting.

- [Introduction of the Whiteboard](#)
- [Using and Viewing the Whiteboard](#)
- [Dual Screen Touch](#)

Introduction of the Whiteboard

Procedure

Introduction of the whiteboard is as below:

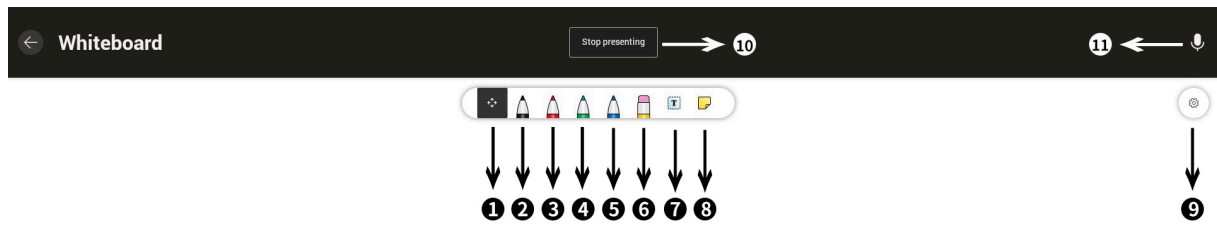

No.	Item
1	Pan and Zoom
2	Black Pen
3	Red Pen
4	Green Pen
5	Blue Pen
6	Eraser
7	Add text
8	Add note
9	Settings
10	Stop presenting
11	Mute microphone

Using and Viewing the Whiteboard

Procedure

During the meeting, select  > **Share Whiteboard**.



Note: You can use the whiteboard to share content if the device connected to a touch display device, otherwise you can only view what others share.

Dual Screen Touch

When you use the whiteboard to share content, you can operate the content via touch screen.

Procedure

1. Plug one USB cable to connect the endpoint and touch screen.
2. Choose one of the HDMI screens as the touch screen. If you only need one touch screen, you can skip step 3.
3. Plug another USB cable to connect the endpoint and another touch screen.

Raising Hand

Everyone in the meeting can raise hands to apply for speaking.

Procedure

During the meeting, select  > **Raise hand**.

Setting the Screen Layout

You can set the layouts as Gallery, Large Gallery, or Together mode.

Procedure

1. Select  when the meeting is more than four people.
2. Select **Gallery**, **Large gallery**, or **Together mode** to change layouts.

Turning on Live Captions

If you enable the live caption feature, the device will add real-time captions to your meeting.



Procedure

During the meeting, select  > **Turn on live captions**.
Live captions are displayed on the display screen.

Leaving a Meeting

Procedure

Do one of the following:

- Select .
- Press the End Call key on your remote control.
- Tap  on your CP900/CP700.

 **Note:** You can leave the meeting by CP900/CP700 only if you are using a USB connection.

Other participants remain connected.

Sharing Content

You can share the content on your computer when the device is idle or in a conference. Only one content can be shared at a time, and the content shared later will replace the previous one. We recommend that you use two screens for sharing content.

- [Sharing Content with VCH51 Video Conferencing Hub](#)
- [Using WPP20 Wireless Presentation Pod](#)

Sharing Content with VCH51 Video Conferencing Hub

In a meeting room, you can connect VCH51 to your PC with HDMI cable for content sharing.

Before you begin

Make sure the computer is powered on and connected to your device.

Procedure

The device will connect to the wired sharing and display the sharing content automatically. If the device does not display the shared content automatically, you can select **Share** to start presenting.

Using WPP20 Wireless Presentation Pod

In a meeting room, you can connect WPP20 to your PC for content sharing. Connect WPP20 to MeetingBar A20/A30, when both MeetingBar A20/A30 and CTP18 prompt “Wireless Presentation Pod Pairing Successfully”, remove WPP20 from the MeetingBar A20/A30. After that, connect WPP20 to the PC and the PC will pop up the wireless presentation software automatically.

- [Sharing Content via WPP20](#)
- [Switching the Shared Content via WPP20](#)
- [Stopping Sharing Content via WPP20](#)

Sharing Content via WPP20

Before you begin

Make sure the computer is powered on and you connect the WPP20 wireless presentation pod to your PC.

Procedure

Do one of the following:

- On the WPP20, press the presentation button to share the full screen of the PC.
- On the WPP20, long press the presentation button for 3 seconds and then release this button. Select the file or window you want to share and then click **Start Sharing**.
- On the Yealink Wireless Presentation Pod software, click **Contents Share**, select the file you want to share, and then click **Start Sharing**.

The computer content is automatically projected to the device.

Switching the Shared Content via WPP20

Procedure

1. On the Yealink Wireless Presentation Pod software, click **New Share**.
2. Select the file or window you want to share and then click **Start Sharing**.

Stopping Sharing Content via WPP20

Procedure

Do one of the following to stop sharing content:

- Remove WPP20 from your computer.
- On the WPP20, press the presentation button.
- On the Yealink Wireless Presentation Pod software, click **Stop Sharing**.

Dual Screen Display

MeetingBar A20/A30 supports dual-screen display.

When the MeetingBar A20/A30 is in the idle interface, one screen displays the main idle interface, and the other screen shows the Teams background.

When the MeetingBar A20/A30 is in a meeting, if not sharing the content, the remote meeting participants are dispersed across both screens. The local meeting video will display in the lower-right corner of the window. If sharing the content, one screen will display the video, and the other screen will display the content.



Camera Settings

You can set multiple camera parameters to make the MeetingBar A20/A30 have better framing in the different meeting room environments.

- [Controlling Camera Position](#)
- [Configuring the Exposure Settings](#)
- [Configuring the White Balance Setting](#)
- [Adjusting Display Image of the Camera](#)
- [Enabling Auto-framing for Camera](#)
- [Enabling Speaker-tracking for Camera](#)
- [PiP Mode](#)
- [Multi-focus Framing](#)
- [Enabling Small FoV Mode for Camera](#)
- [Camera Pan Direction](#)
- [Resetting the Camera](#)

Controlling Camera Position

Procedure

1. Go to **More > Settings > Device Settings > Control**.
2. Do one of the following:
 - Select  /  to control camera zoom out/in.
 - Select the arrow keys to pan/tilt the camera.
 - Select **Reset** to reset the position for camera.

Configuring the Exposure Settings

Procedure

1. Go to **More > Settings > Device Settings > Exposure Settings**.
2. Select the desired mode from the **Exposure Mode** field.

For MeetingBar A20:

- If you select **Auto Exposure**:
Select the desired value from the **Exposure Compensation, Flicker, Gain Limit, Wide Dynamic Range, Metering** field respectively.
- If you select **Manual Exposure**:
Select the desired value from the **Gain Limit, Wide Dynamic Range, Shutter** field respectively.
- If you select **Shutter Priority**:
Select the desired value from the **Exposure Compensation, Gain Limit, Wide Dynamic Range, Metering, Shutter** field respectively.
- If you select **Brightness Priority**:
Select the desired value from the **Flicker, Wide Dynamic Range, Metering, Brightness** field respectively.

For MeetingBar A30:

- If you select **Auto Exposure**:
Select the desired value from the **Flicker** field respectively.
- If you select **Manual Exposure**:
Select the desired value from the **Shutter, Brightness** field respectively.
- If you select **Shutter Priority**:
Select the desired value from the **Shutter** field respectively.
- If you select **Brightness Priority**:
Select the desired value from the **Brightness** field respectively.

Configuring the White Balance Setting

Procedure

1. Go to **More > Settings > Device Settings > White Balance Setting**.
2. Select the desired value from the **White Balance Mode** field and select **OK**.
 - **Auto** (default), it calculates the best white balance setting based on lighting conditions in the room.
 - **Indoor**
 - **Outdoor**
 - **One push** (MeetingBar A20)
 - **ATW** (MeetingBar A20), it automatically adjusts the white balance according to the picture taken by the camera.
 - **Manual Setting** (MeetingBar A20), you can manually adjust the color temperature in the **Temperature** field.
 - **Incandescent** (MeetingBar A30)
 - **Fluorescent** (MeetingBar A30)
 - **Cloudy Daylight** (MeetingBar A30)

Adjusting Display Image of the Camera

Procedure

1. Go to **More > Settings > Device Settings > Graphics**.
2. Select the desired mode from the **Display Mode** field.
 - **High Definition**
 - **Standard**
 - **Mild**
 - **Custom**, you can adjust the **Saturation** and **Sharpness** respectively, and select the desired mode from the **Noise Reduction(2D)** field.

Enabling Auto-framing for Camera

Auto-framing is mainly based on face detection, which provides real-time detection and position tracking on all faces in the conference room. All participants in the output screen are covered and the camera can be automatically adjusted according to the number of participants and the position changes.

About this task

When the auto-framing feature is enabled, you cannot control the camera position.

Procedure

1. Go to **More > Settings > Device Settings > Others**.
2. Select **Auto Framing** in **Framing Mode** field.

Enabling Speaker-tracking for Camera

Speaker-tracking is based on auto-framing, which can automatically focus on the speaker in the meeting.

Procedure

1. Go to **More > Settings > Device Settings > Others**.
2. Select **Speaker Tracking** in **Framing Mode** field.



Note: When you turn on voice-tracking, auto-framing will turn on automatically.

PiP Mode

The MeetingBar A20 supports panoramic and close-up views in a picture-in-picture format, allowing you to see all participants clearly and focus on the speaker at the same time during a meeting. Through professional voice positioning and image analysis technology, MeetingBar A20 enables automatic tracking and shooting close-ups of speakers and intelligent image adjustment without manual intervention.

About this task



Note: It is only applicable to the MeetingBar A20.

Procedure

1. Go to **More > Settings > Device Settings > Others**.
2. Select **PiP Mode(Beta)** in **Framing Mode** field.

Multi-focus Framing

MeetingBar A20 supports multi-person close-up split screen, making meeting communication more efficient. In order to create a perfect video meeting experience, it is recommended that the distance between each participant should be at least 30cm.

About this task

This function is suitable for horizontal meeting rooms, and supports up to six participants to split the screen at the same time. When there are more than six participants, the meeting screen switches to Auto Framing mode to display all users.



Note: It is only applicable to the MeetingBar A20 with V1 version hardware. For more information about the V1/V0 version hardware, refer to: [Yealink MeetingBar Series Teams Edition Release Notes](#).

Procedure

1. Go to **More > Settings > Device Settings > Others**.
2. Select **Multi-focus Framing(Beta)** in **Framing Mode** field.

Enabling Small FoV Mode for Camera

Small FoV mode supports cropping the camera image into different field of view to display the image more concentratedly.

Procedure

1. Go to **More > Settings > Device Settings > Others**.
2. Select **Small FoV mode** in **Framing Mode** field.
3. Select the desired view from the **Field of View** field:
 - 70°
 - 90°

Camera Pan Direction

Procedure

1. Go to **More > Settings > Device Settings > Others**.
2. Select the desired value from the **Camera Pan Direction** field.

If you select **Reversed**, the camera pan direction will be reversed when pressing the left and right navigation keys on the remote control.

Resetting the Camera

You can reset the camera to factory defaults.

Procedure

1. Go to **More > Settings > Device Settings > Others**.
2. Select **Reset Camera**.
3. Select **OK** to reset the camera.

Teams Device Settings

- [Changing the Backlight Time](#)
- [Audio Settings](#)
- [Bluetooth](#)
- [Wireless Network](#)
- [Accessibility Features](#)

Changing the Backlight Time

The backlight brightness automatically changes after the device has been idle for a specified time.

About this task

You can change the backlight time in the following settings:

Backlight Time: The delay time to change the brightness of the LCD screen when the device is inactive. Backlight time includes the following settings:

- **15s, 30s, 1min, 2min, 5min, 10min, 30min, 45min or 1h:** The backlight is turned off when the device is inactive after the designated time.

Procedure

1. Go to **More > Settings > Device Settings > Display**.
2. Select the desired time from the **Backlight Time** field.
3. Press **OK**.

Audio Settings

You can connect additional audio devices and choose the way of audio input and output.

- [Setting Audio Input/Output Device](#)

Setting Audio Input/Output Device

Procedure

Go to **More > Settings > Device Settings > Audio Input/Output Device** and choose one of the following:

- Auto
- Built-in Microphone/Speaker
- Line In/Out

Bluetooth

The Teams device supports Bluetooth.

- [Activating or Deactivating the Bluetooth Mode](#)
- [Enabling/Disabling Your Device Discovery](#)
- [Disconnecting the Bluetooth Device](#)

Activating or Deactivating the Bluetooth Mode

You need to activate Bluetooth mode to use the Bluetooth feature and you can deactivate the Bluetooth mode when you no longer use a Bluetooth device.

Procedure

1. Go to **More > Settings > Device Settings > Bluetooth**.
2. Turn on/off **Bluetooth**.

Enabling/Disabling Your Device Discovery

You can enable/disable this feature to allow/disallow your device to be discovered by other Bluetooth devices.

Procedure

1. Go to **More > Settings > Device Settings > Bluetooth**.
2. Turn on/off **Open Discover**.

Disconnecting the Bluetooth Device

You can disconnect the Bluetooth device from your device. After the Bluetooth device is disconnected, it stays in the paired devices list so that you can easily connect it to your device next time.

Procedure

1. Go to **More > Settings > Device Settings > Bluetooth**.
2. Select the connected Bluetooth device.
It prompts if you are sure to disconnect.
3. Select **OK**.

Wireless Network

The Teams device supports the Wi-Fi feature. If there is available Wi-Fi, you can enable the Wi-Fi feature to connect the device to the wireless network.

- [Activating or Deactivating the Wi-Fi Mode](#)
- [Connecting to the Wireless Network](#)
- [Viewing the Wireless Network Information](#)
- [Disconnecting the Wireless Network Connection](#)

Activating or Deactivating the Wi-Fi Mode

You can activate the Wi-Fi mode if you need to connect your device to the wireless work or deactivate the Wi-Fi mode when you need to connect your device to the wired network.

Procedure

1. Go to **More > Settings > Device Settings > Wi-Fi (Admin only, default password: 0000)**.
2. Turn on/off **Wi-Fi**.

Connecting to the Wireless Network

There are two ways to connect the device to the wireless network.

- [Connecting to an Available Wireless Network Manually](#)
- [Adding a Wireless Network manually](#)

Connecting to an Available Wireless Network Manually

Before you begin

Get the password of the wireless network from your system administrator.

Make sure that the Wi-Fi mode is activated.

Procedure

1. Go to **More > Settings > Device Settings > Wi-Fi (Admin only, default password: 0000)**.
2. Select  > **Scan** to search the available wireless network.
3. Select the desired wireless network.
4. If the network is secure, enter its password.
5. Select **CONNECT**.

Related tasks

[Activating or Deactivating the Wi-Fi Mode](#)

Adding a Wireless Network manually

If your gateway/router has SSID broadcast disabled, it might not appear in the scanning results. In that case, you must manually add a wireless network.

Before you begin

Make sure Wi-Fi Mode is activated.

Procedure

1. Go to **More > Settings > Device Settings > Wi-Fi (Admin only, default password: 0000)**.
2. Select  > **Add**.
3. Enter the SSID and then select a security mode from the **Security** drop-down menu:
 - If you select **None**, select **Save**.
 - If you select **WEP** or **WPA/WPA2-PSK**, enter the password and then select **Save**.
 - If you select **802.1x/EAP**, select the desired EAP method and Phase-2 authentication, enter the desired values in the **Identity**, **Anonymous identity**, and **Password** fields and then select **Save**.

If you enable **Show advanced options**, select a desired value in the **Proxy** field; and if you select **Manual**, enter the information about the proxy server in the corresponding fields.

Related tasks

[Activating or Deactivating the Wi-Fi Mode](#)

Viewing the Wireless Network Information

After connecting to the wireless network, you can view the wireless network information (such as wireless status, link speed, security, IP address, signal strength, etc.)

Procedure

1. Go to **More > Settings > Device Settings > Wi-Fi (Admin only, default password: 0000)**.
2. Select the connected wireless network.

Disconnecting the Wireless Network Connection**Procedure**

1. Go to **More > Settings > Device Settings > Wi-Fi (Admin only, default password: 0000)**.
2. Select the connected wireless network.
3. Select **FORGET**.

The wireless network is disconnected. You can tap it again to connect.

Accessibility Features

The device includes a number of features to accommodate vision-impaired users.

- [Large Text](#)
- [High Contrast Mode](#)
- [Color Correction](#)

Large Text

You can change the displayed text size.

Procedure

1. Go to **More > Settings > Device Settings > Accessibility**.
2. Turn on **Large Text**.

High Contrast Mode

You can change the contrast if any difficulties in reading text on the screen.

Procedure

1. Go to **More > Settings > Device Settings > Accessibility**.
2. Turn on **High Contrast Mode**.

Color Correction

You can change color mode if any difficulties in color recognition.

Procedure

1. Go to **More > Settings > Device Settings > Accessibility**.
2. Select the desired value from the **Color Correction** field.
 - Off
 - Deuteranomaly (red-green)
 - Protanomaly (red-green)
 - Tritanomaly (blue-yellow)
3. Select **OK**.

Getting More Information About Microsoft Teams

This topic provides you to view more information about Microsoft Teams. If you encounter problems when using the Teams device, you can send feedback to Microsoft.

- [Viewing More Information About Microsoft Teams](#)
- [Company Portal](#)
- [Sending Feedback](#)

Viewing More Information About Microsoft Teams

You can view more information about Microsoft Teams, such as the version, calling version, and the details of Privacy & Cookies, Microsoft Software License Terms, and Third-party Notices.

Procedure

Go to **More > Settings > About**.

You can select **Privacy & Cookies**, **Terms of Use**, or **Third Party Software Notices and Information** to view the details.

Company Portal

Microsoft Intune helps organizations manage access to corporate apps, data, and resources. Company Portal is the app that lets you, as an employee of your company, securely access those resources. Before you can use this app, make sure your IT admin has set up your work account and have a subscription to Microsoft Intune.

Company Portal helps simplify the tasks you need to do for work:

- Enroll your device to access corporate resources, including Office, email, and OneDrive for Business
- Sign into corporate resources with company-issued certificates
- Reduce the number of times you need to sign into corporate resources with single sign-on
- Browse and install approved business apps from your IT department or the Microsoft Store for Business
- View and manage your enrolled devices and wipe them if they get lost or stolen
- Get help directly from your IT department through the available contact information



Note: Every organization has different access requirements and will use Intune in ways that they determine will best manage their information. Some functionality might be unavailable in certain countries. If you have questions about how this app is being used within your organization, contact your company's IT administrator.

Sending Feedback

If you encounter problems while using the Teams device, please feel free to send feedback to let us know.

Procedure

1. Go to **More > Settings > Report an issue**.
2. Select a desired report type in the **Type** field.
3. Enter the alias (your email address).
4. Select a desired type of issue and then enter the issue title.
5. Select **SEND**.

Maintaining Teams Devices

When the device cannot be operated properly, you can investigate or troubleshoot issues along with any other tasks your administrator may ask you to perform.

- [Rebooting Your Device](#)

- [Viewing Device Status](#)
- [Resetting Your Device](#)

Rebooting Your Device

Your system administrator may ask you to reboot your device if it malfunctions or to assist in troubleshooting.

Procedure

1. Go to **More > Settings > Device Settings > Reboot**.
2. Select **Reboot phone**.
It prompts if you are sure to reboot the device.
3. Select **OK**.

Viewing Device Status

Your system administrator may ask you to view the device status such as network, MAC, firmware, Partner APP version, Company Portal version, and Teams version.

Procedure

Go to **More > Settings > Device Settings > About**.

Resetting Your Device

You can reset the device to factory settings with the need for entering the Administrator's password.

Procedure

1. Go to **More > Settings > Device Settings > Debug (Admin only, default password: 0000)**.
2. Select **Reset to Factory Settings**.
It prompts if you are sure to reset to factory default.
3. Select **OK**.

Troubleshooting

If you are having issues with your device, you can try the troubleshooting options and solutions in the following topics to resolve certain issues.

- [Why does the device display "Network unavailable"?](#)
- [Why do the device display time and date incorrectly?](#)
- [How can I obtain the MAC address when the device is not powered on?](#)
- [How can I switch to Teams edition?](#)
- [Checking the IP Address of Device](#)

Why does the device display “Network unavailable”?

- Ensure that the switch or hub in your network is operational.

Why do the device display time and date incorrectly?

Check whether your device obtains the time and date from the SNTP server automatically. If the device fails to connect the SNTP server, contact your system administrator for more information. You can also configure the time and date manually.

How can I obtain the MAC address when the device is not powered on?

You can use one of the following ways to obtain the MAC address of a device:

- The PO (Purchase Order) provided by the supplier.
- The label of the carton box.
- The device’s bar code on the back of the device.

How can I switch to Teams edition?

If your device is not the Teams edition, you can switch to the Teams edition.

Procedure

Do one of the following:

- Upgrade firmware via the web user interface.
- Auto provisioning.

Checking the IP Address of Device

Procedure

Go to **More > Settings > Device Settings > About**.