



VC01A

Integrated video conference terminal

User Manual



Disclaimer

BenQ Corporation makes no representations or warranties, either expressed or implied, with respect to the contents of this document. BenQ Corporation reserves the right to revise this publication and to make changes from time to time in the contents thereof without obligation to notify any person of such revision or changes.

HDMI trademark disclaimer (for models with HDMI inputs)

The terms HDMI and HDMI High-Definition Multimedia Interface, and the HDMI Logo are trademarks or registered trademarks of HDMI Licensing Administrator, Inc. in the United States and other countries.



Copyright

Copyright 2022 BenQ Corporation. All rights reserved. No part of this publication may be reproduced, transmitted, transcribed, stored in a retrieval system or translated into any language or computer language, in any form or by any means, electronic, mechanical, magnetic, optical, chemical, manual or otherwise, without the prior written permission of BenQ Corporation.

Product support

This document aims to provide the most updated and accurate information to customers, and thus all contents may be modified from time to time without prior notice. Please visit the website for the latest version of this document and other product information. Available files vary by model.

1. Make sure your computer is connected to the Internet.
2. Visit the local website from www.BenQ.com. The website layout and content may vary by region/country.
 - User manual and related document: www.BenQ.com > **Business** > **SUPPORT** > **Downloads** > model name > **User Manual**
 - (EU only) Dismantled information: Available on the user manual download page. This document is provided based on Regulation (EU) 2019/2021 to repair or recycle your product. Always contact the local customer service for servicing within the warranty period. If you wish to repair an out-of-warranty product, you are recommended to go to a qualified service personnel and obtain repair parts from BenQ to ensure compatibility. Do not disassemble the product unless you are aware of the consequences. If you cannot find the dismantled information on your product, contact the local customer service for assistance.

Table of Contents

Safety warnings and precautions.....	1
Important safety instructions	2
Safety notice for remote control	2
Battery safety notice	2
Package contents.....	4
Installation instructions.....	5
Product interface	5
Input/output terminals.....	5
Remote control.....	7
Mounting	10
Installing the wall mount	10
Installing the display mount	11
Connections	12
Connecting power	13
Working with the built-in OS of the product (All-in-one mode)	14
Connect your personal device to the product (BYOD mode).....	15
Basic operations	16
Turning the product on or off	16
Initial setup	16
Updating software.....	17
Android system interface	18
Main interface	18
Account Information.....	20
Menu operations	23
Setting up the Internet connection.....	23
Adjusting audio volume level.....	26
Device settings.....	27
System settings	29
Apps	30
Project wirelessly via InstaShare 2	32
AMS file manager overview	34
Camera settings.....	39
BenQ App Store.....	41
InstaQPrint.....	42
WPS Office.....	43
Saffi	45
Product information	47
Specifications.....	47
Dimensions	49
Troubleshooting.....	50

Safety warnings and precautions



The lightning flash with arrowhead symbol, within an equilateral triangle, is intended to alert the user to the presence of uninsulated “dangerous voltage” within the product’s enclosure that may be of sufficient magnitude to constitute a risk of electric shock to persons.



The exclamation point within an equilateral triangle is intended to alert the user to the presence of important operating and maintenance (servicing) instructions in the literature accompanying the appliance.

- The mains plug of the power supply cord shall remain readily operable. The AC receptacle (mains socket outlet) shall be installed near the equipment and shall be easily accessible. To completely disconnect this equipment from the AC mains, disconnect the power cord plug from the AC receptacle.
- Do not place this product on an uneven, sloping or unstable surface (such as a trolley) where it may fall and cause damage to itself or others.
- Do not place this product near water, like a spa or pool, or in a position which will allow the splashing or spraying of water onto the product, like in front of an open window where rain water may enter.
- Do not install this product in a confined space without proper ventilation and air circulation, such as in a closed cabinet. Allow proper space around the product for dissipating heat inside. Do not block any openings and vents on the product. Overheating may result in hazards and electric shock.
- Installation of this product should only be performed by a qualified technician. Failure to install this product properly may cause injuries and damages to the personnels and the product itself. Check the installation regularly and maintain the product periodically to ensure the best working condition.
- Use only the accessories approved or recommended by the manufacturer to mount this product. Using wrong or unsuitable accessories may cause the product to fall and result in serious personal injuries. Make sure that the surface and fixing points are strong enough to sustain the weight of the product.
- To reduce the risk of electric shock, do not remove covers. No user serviceable parts inside. Refer servicing to qualified service personnel.
- To prevent personal injuries, mounting the product is required before use.

Important safety instructions

1. Read these instructions.
2. Keep these instructions.
3. Heed all warnings.
4. Follow all instructions.
5. Do not use this apparatus near water.
6. Clean only with dry cloth.
7. Do not block any ventilation openings. Install in accordance with the manufacturer's instructions.
8. Do not install near any heat sources such as radiators, heat registers, stoves, or other apparatus (including amplifiers) that produce heat.
9. Do not defeat the safety purpose of the polarized or grounding-type plug. A polarized plug has two blades with one wider than the other. A grounding-type plug has two blades and a third grounding prong. The wide blade or the third prong are provided for your safety. If the provided plug does not fit into your outlet, consult an electrician for replacement of the obsolete outlet.
10. Protect the power cord from being walked on or pinched particularly at plugs, convenience receptacles, and the point where they exit from the apparatus.
11. Only use attachments/accessories specified by the manufacturer.
12. Use only with the cart, stand, tripod, bracket, or table specified by the manufacturer, or sold with the apparatus. When a cart is used, use caution when moving the cart/apparatus combination to avoid injury from tip-over.
13. Unplug this apparatus during lightning storms or when unused for long periods of time.
14. Refer all servicing to qualified service personnel. Servicing is required when the apparatus has been damaged in any way, such as power-supply cord or plug is damaged, liquid has been spilled or objects have fallen into the apparatus, the apparatus has been exposed to rain or moisture, does not operate normally, or has been dropped.



Safety notice for remote control

- Do not put the remote control in the direct heat, humidity, and avoid fire.
- Do not drop the remote control.
- Do not expose the remote control to water or moisture. Failure to do so could result in malfunction.
- Confirm there is no object between the remote control and the remote sensor of the product.
- When the remote control will not be used for an extended period, remove the batteries.

Battery safety notice

The use of the wrong type of batteries may cause chemical leaks or explosion. Please note the following:

- Always ensure that the batteries are inserted with the positive and negative terminals in the correct direction as shown in the battery compartment.

-
- Different types of batteries have different characteristics. Do not mix different types.
 - Do not mix old and new batteries. Mixing old and new batteries will shorten battery life or cause chemical leaks from the old batteries.
 - When batteries fail to function, replace them immediately.
 - Chemicals which leak from batteries may cause skin irritation. If any chemical matter seeps out of the batteries, wipe it up immediately using a dry cloth, and replace the batteries as soon as possible.
 - Due to varying storage conditions, the battery life for the batteries included with your product may be shortened. Replace them within 3 months or as soon as you can after initial use.
 - There may be local restrictions on the disposal or recycling of batteries. Consult your local regulations or waste disposal provider.

Package contents

Open the sales package and check the contents. If any item is missing or damaged, please contact your dealer immediately.

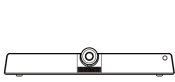

Integrated video conference terminal

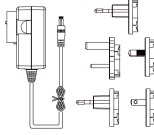

Adapter and plug (by region) x 1

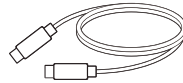

USB Type-C cable x 1

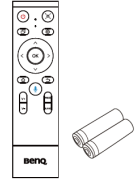

2.4GHz remote control and AAA battery x 2

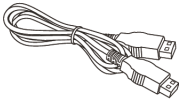

HDMI cable x 1



Quick start guide



Camera cover x 1

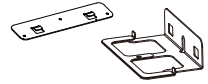

Mounting kit



- “Integrated video conference terminal” will hereinafter be referred to as “the product” in this document.
- Before discarding the package, check that you haven’t left any accessories inside the box.
- Dispose of packaging materials wisely. You can recycle the cardboard carton. Consider storing the package (if possible) for future transport of the display.
- Do not leave plastic bags within reach of young children or babies.

Installation instructions

Product interface

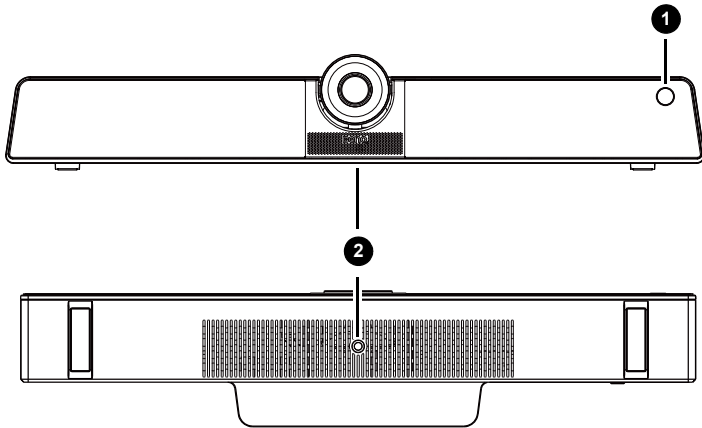

No	Name	Description
1	IR Signal Receiver	Receive IR signals. Do not obstruct the receiver.
2	Screw hole	Screw hole for mounting.

Input/output terminals

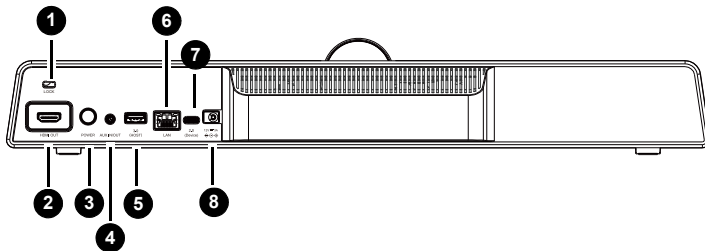

No	Name	Description
1	LOCK	For Kensington lock.
2	HDMI OUT (Video only)	Connect to display devices with an HDMI input.
3	Power	Press button to turn it on or off.





No	Name	Description
4	AUX IN/OUT (Mic in/Audio out)	Connect to external audio equipment.
5	USB 3.0 (Host) (Type-A)	Connect USB devices such as USB keyboards, USB mouse, and USB flash drives. Used for upgrading.
6	LAN	Connect RJ45 terminals.
7	USB 2.0 (Device) (Type-C)	Connect to the PC for external camera, microphone and speaker from the product.
8	DC	Used for 12V power supply.



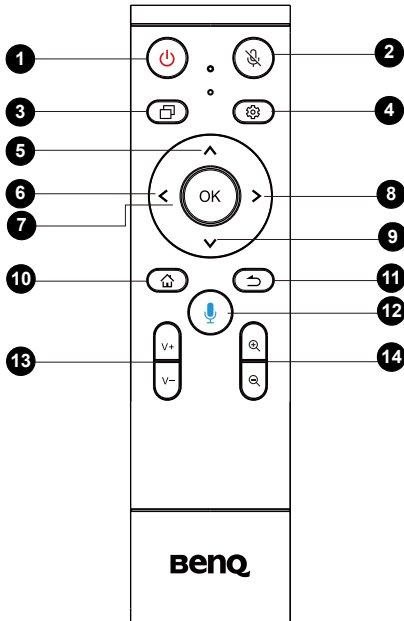





- USB 3.0= 5V \equiv 900mA
- \equiv : Direct Current / DC
- \sim : Alternating Current /AC
- The maximum length for the cables to be used with the USB slots are 5m (USB 2.0) and 3m (USB 3.0).

Remote control



- 1**  Turn the display on or off.
- 2**  Press to mute/unmute microphone.
- 3**  Press to open **Side toolbar**.
- 4**  Press to open or close the OSD menu.
- 5**  Direction key. Press for upward selection.

- 6**  Direction key. Press for left selection.
- 7** **OK**
Press to proceed.
- 8**  Direction key. Press for right selection.
- 9**  Direction key. Press for downward selection.
- 10**  Android system main screen button.
- 11**  Return key.
- 12**  Voice command key. Press to activate Saffi (BenQ Voice Assistant).
- 13** **V+ V-**
Volume up/down.
- 14**  Press to zoom in/out.

Using the remote control

Installing remote control batteries

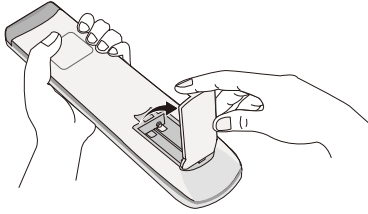

1. Open the remote control battery compartment cover.

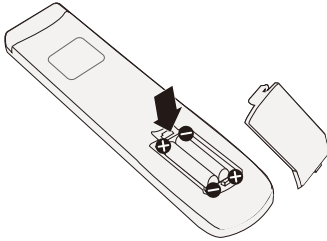

2. Insert two AAA batteries into the battery compartment ensuring that the (+) and (-) signs on the batteries match the (+) and (-) indications on the battery compartment.

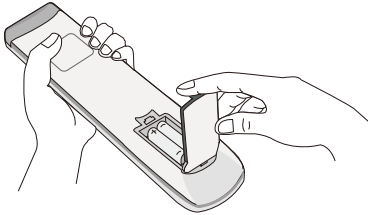

3. Re-install the battery compartment cover.



This remote control applies only to a specific model and/or operating systems. Contact your reseller if you have any question.

Remote control usage tips

- To power on/off the product, aim the top front of the remote control directly at the product's remote control sensor window when you press the buttons.
- Avoid getting the remote control wet or store it in humid environments (like bathrooms).
- If the product's remote control sensor window is exposed to direct sunlight or strong light, the remote control may not operate properly. In this situation, change the light source, readjust the angle of the product, or operate the remote control from a location closer to the product's remote control sensor window.

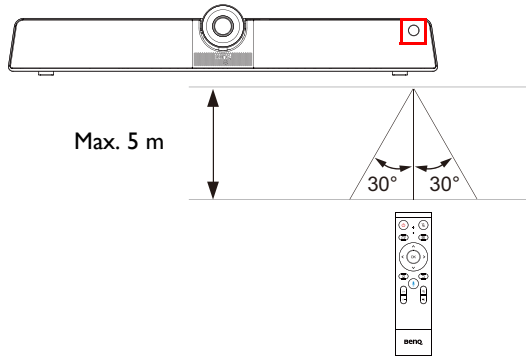

Mounting

Select either way to install the product:

- Install the product on the wall mount with the provided mounting components. Refer to [Installing the wall mount on page 10](#) for more information.
- Mount the product directly to any tripod or bracket with the lock screw. Refer to [Installing the display mount on page 11](#) for more information.

Installing the wall mount

Check the mounting component list before installing:

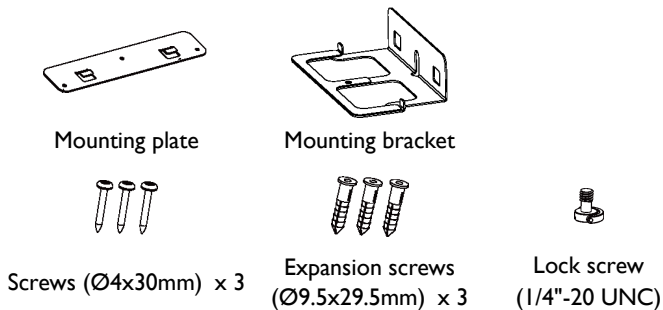

To install the wall mount:

1. Install three expansion screws into the wall.
2. Install the mounting plate with three screws and secure it on the wall.

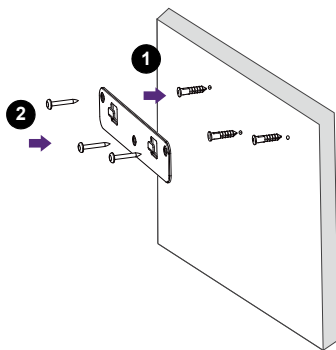

3. Hook the mounting bracket onto the mounting plate.

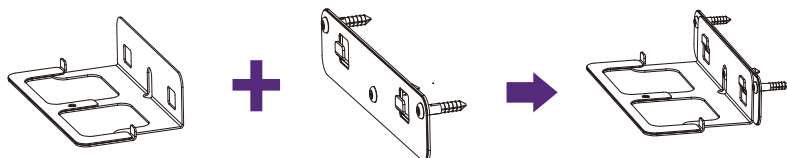

4. Place the product onto the mounting bracket and secure the product by screwing the lock screw into the product's screw hole.

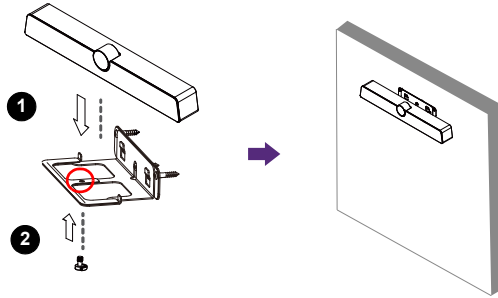

Installing the display mount

You may attach the product to the display by installing the product directly to any tripod or bracket with the lock screw.

To attach the product on the display mount:

1. Place the product onto a mounting bracket.
2. Secure the product by screwing the lock screw into the product's screw hole.

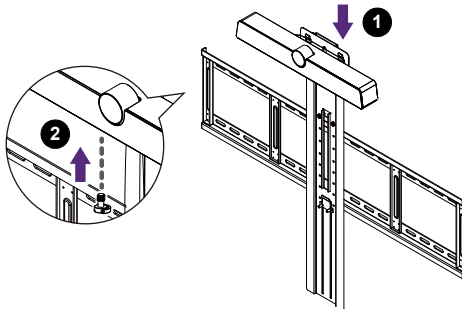

Connections

Two modes are provided for you to connect the product:

- **All-in-one mode:** In this mode, you can work with the built-in operating system and software of the product to make the most of your monitor. To enjoy all features of the product, connecting via **All-in-one mode** is highly recommended. Refer to [Working with the built-in OS of the product \(All-in-one mode\) on page 14](#) for more information.



You can project your computer wirelessly via built-in software of the product. Refer to [Project wirelessly via InstaShare 2 on page 32](#) for more information.

- **Bring-your-own-device mode (BYOD mode):** In this mode, you can keep the operating system of your device while using the product as the external camera, microphone and speaker for a more enhanced meeting experience. Refer to [Connect your personal device to the product \(BYOD mode\) on page 15](#) for more information.



You can adjust the camera's angle of view by using the built-in **Camera Settings** app in the product. Connect via **All-in-one mode** to launch the **Camera Settings** app before connecting through **BYOD mode**. Refer to [Camera settings on page 39](#) for more information.

Comparison between two modes:

Mode	Functions provided by the product	
	Operating System	Camera, Microphone, Speaker
All-in-one mode	○ (Built-in OS of VC01A)	○ (Set by default)
BYOD mode	N/A (OS of user's own device)	○ (Select VC01A as source)

Connecting power

Plug one end of the power cord into the power jack of the product and the other end into an appropriate power outlet (if the outlet is switched, turn on the switch).

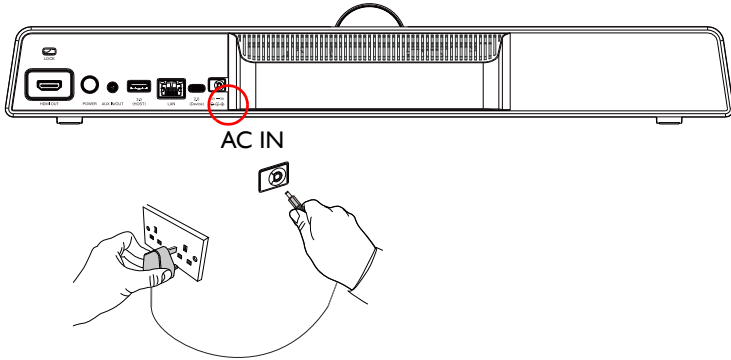

- The supplied power cord is suitable for use with 100-240V AC power only.
- The power cord and outlet illustrated may differ from the ones used in your region.
- Only use an appropriate power cord for your region. Never use a power cord which appears damaged or frayed, or change the plug type on the power cord.
- Be aware of the power loading when you use extension cords or multiple outlet power boards.
- The illustration is for your reference only.

Working with the built-in OS of the product (All-in-one mode)

By connecting the product with a HDMI cable, the product functions as your monitor's operating system, which serves as your conference camera and offers apps for wireless projection, collaborative meetings, files management, etc.

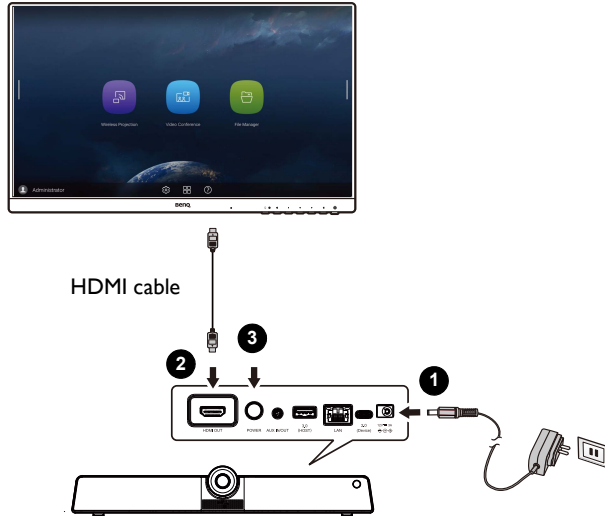

To enable **All-in-one mode**:

1. Connect power to the product.
2. Connect the product to the monitor through a HDMI cable.
3. Power on the product.
4. To share the screen of your own device (such as laptop, tablet or smartphone) to the display wirelessly, refer to [Project wirelessly via InstaShare 2 on page 32](#) for more information.

Connect your personal device to the product (BYOD mode)

In **Bring-your-own-device mode (BYOD mode)**, the product is connected to your personal device through a USB Type-C cable. The built-in operating system of the product will not function. In other words, you can keep working with your own OS during meetings while choosing VC01A as the audio and video source for your device.



Refer to the OS requirements for **BYOD mode** as below: Win 10/Win 8/Win 7/Win XP/ Linux OS/Mac OS/Chrome OS.

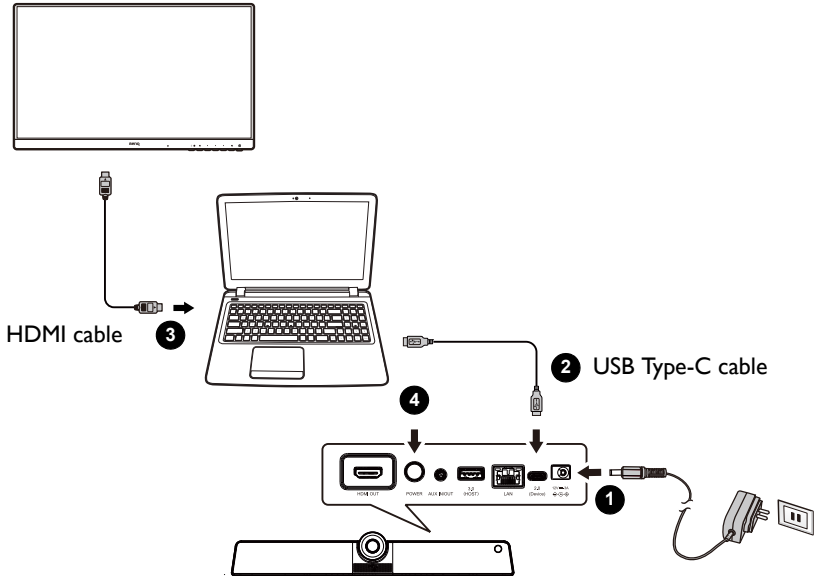



To enable **BYOD mode**:

1. Connect power to the product.
2. Connect the product to your personal device with a USB Type-C cable. Plug-in to **USB 2.0 (Device)** port on the rear of the product and and the USB Type-C port of your own device.
3. (Optional) Connect TV/monitor to your device through a HDMI cable to share your screen to everyone in the room.
4. Power on the product.

Basic operations

Turning the product on or off

- Be sure to follow the instruction of [Connecting power on page 13](#).
- To turn on the product, press the **Power** button on the back of the product or  on the remote control.
- To turn off the product, press the **Power** button on the back of the product or  on the remote control.

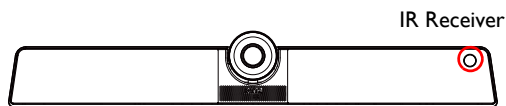
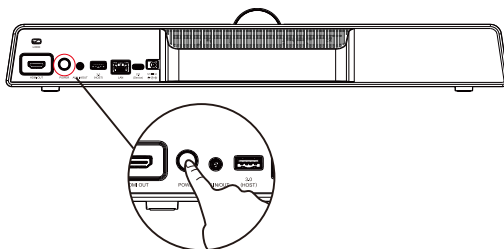

Initial setup

After you have connected the product to the power, you are ready to power on the product. The first time you power it on, you will be guided through a series of setup screens. Follow the on-screen instructions or the steps below to start up and complete the initial setup.

1. Turn on the product. Wait for it to boot up with the BenQ screen. This may take a moment.
2. Tap **Next** on the screen to begin. Follow the on-screen instructions to set up the language, date and time, and network. Or you can skip some of these steps and complete the setup later.



To adjust other settings, you can press  on the remote control to enter the OSD menu again. Refer to [Menu operations on page 23](#) for more information on the OSD menus and their settings.

Updating software

Whenever a new version of software is available, the system will automatically detect the update and will prompt you to download it every time you turn on the product. If you want to update the software, choose **NETWORK UPDATE** or **USB UPDATE** to continue the update. Or you can skip this step and update the software later.

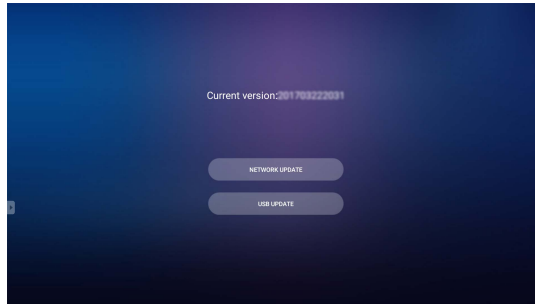

To manually update the software:

1. Go to **System > About > System updates**.

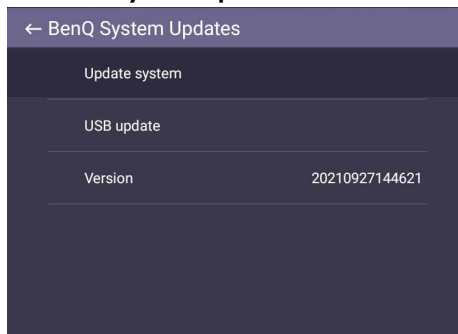

2. If there is an update available, the system will begin updating.



- Software update process may take some time to complete.
- During the update process, do not turn off the product or disconnect the Internet connection. Any interruptions during the software update process may permanently damage the product.

Android system interface



Note that this is a closed Android OS. Download and use of unauthorized apps on this system are not available.

Main interface

The product launches the Android main interface by default. Press on the remote control or right click on a mouse to return to the main interface.

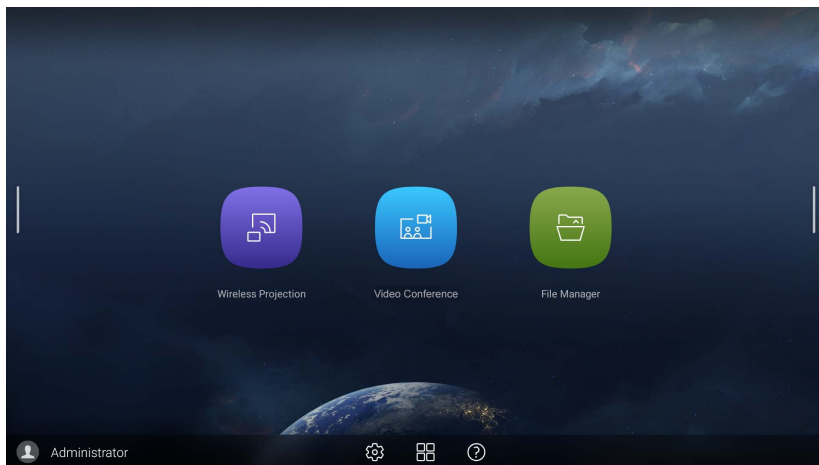





Icon	Function	Description
	Wireless Projection	Shortcut links to InstaShare 2. Refer to Project wirelessly via InstaShare 2 on page 32 for more information.
	Video Conference	Shortcut links to TeamViewer Meeting.
	File Manager	Shortcut links to AMS files. Refer to AMS file manager overview on page 34 for more information.
	OSD Settings	Click to open or close the OSD settings menu.
	All Apps	Click to access all apps and widgets. Refer to Apps on page 30 for more information.
	Help	Click to access online tutorial videos and manuals.

Side tool bar

Tap the side bars at the left or right of the Android main interface to access the side tool bar.



Icon	Function	Description
	Home	Tap to return to the main interface.
	Back	Tap to return to the previous screen.
	All Apps	Tap to show all apps. Refer to Apps on page 30 for more information.
	Recent	Tap to show recently opened apps in list.

Account Information

Three types of accounts are provided: Guest, Admin, and Multiple users.

Guest

It's for public use under Guest account. You are able to change the headshot, wallpaper, volume and brightness.

Admin

Log in as Admin. Under **Personal settings**, you can change the headshot, wallpaper, and password. You can also enable **AMS service**, set **Available offline accounts**, and check **Device information**.



Multiple users

Before logging in as User, be sure to enter the correct email address and activate **AMS service**.

To access your personal account, you have to ask the administrator to activate AMS service first and create your account through **IAM** service. Refer to [User Management on page 21](#) for more information.

For more information and tutorial videos about the AMS service please visit <https://www.benq.com/en-us/business/ifp/account-management-system.html>.

User Management

To add a new user, please contact your IT manager to create your account through BENQ IAM web service.

Creating a new account

1. As an administrator to create a new account for regular users, go to BenQ Service website: <https://iam.benq.com>. Suggested browsers are Chrome and Firefox.
2. Log in and choose **IAM**.

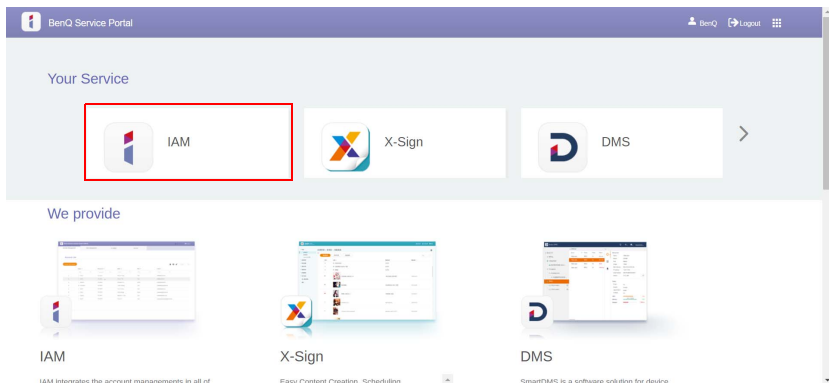

3. Click **Create New Account** to continue.

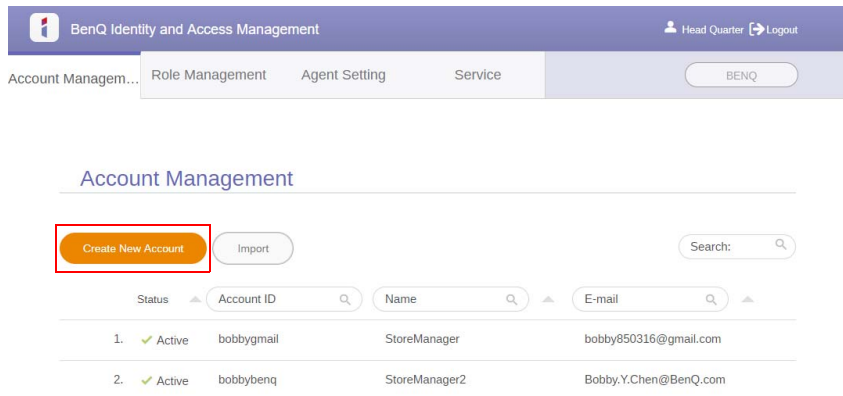

- Fill in the following fields. Be sure to enter the correct email address. Click **Submit** to create a new account.



If some members in your organization need more privilege to control the AMS service, you can activate the users as other roles. You can also activate **X-Sign**, **DMS**, and/or **Broadcast** when creating user accounts.

BenQ Identity and Access Management

Account Management | Role Management | Agent Setting | Service

Create New Account

E-mail

Use email as account ID

Account ID

REMINO: Please do NOT using your personal data to fill the account name. It may increase the risk to reveal your privacy.

Password

Confirm Password

Name

Company BenQ

Country/Area Taiwan

Timezone [UTC+08:00] Taipei

Note

Service Setting

Set this account as substitute administrator, has all of the permissions, two accounts at most

Enable Service	Role	Action
<input checked="" type="checkbox"/> X-Sign	Schedule Manager	Create a new role
<input type="checkbox"/> DMS	Guest	Create a new role
<input type="checkbox"/> AMS	User	Create a new role
<input checked="" type="checkbox"/> Broadcast		

Submit Cancel



You can easily switch to different services, **X-Sign**, **DMS**, and **Broadcast** by clicking the icon on the upper right corner.

- The account has been created and a verifying email is sent to the new account owner.

Message ×

The account has been created. We'll send the email from "BenQ". If it isn't in your inbox, check your folders. If a spam filter or email rule moved the email, it might be in the Spam, Junk, Trash, Deleted items, or Archive folder.

Close

Menu operations

- Press **▲/▼/◀/▶** on the remote control and press **OK** to confirm or directly click an item.
- Press **↩** on the remote control or click a blank area outside the menu to exit the menu.

Setting up the Internet connection

Your display must be connected to a network to conduct OTA updates or surf the Internet.



To find the MAC address in Android OS, please go to **Setting > System > About > Status**.

Network setting

On the home screen, go to **Setting > System > About > Status**. If there is no IP address shown, please connect the display to the ethernet cable.

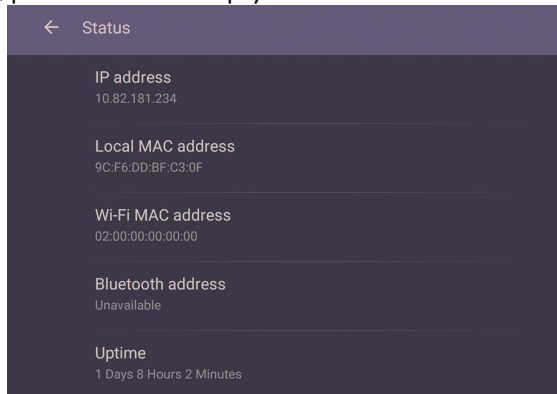

Wireless connection

To make sure the product is connected to Wi-Fi, follow the steps below:

1. Press **⚙** on the remote control, or go to **Network > Wi-Fi**.

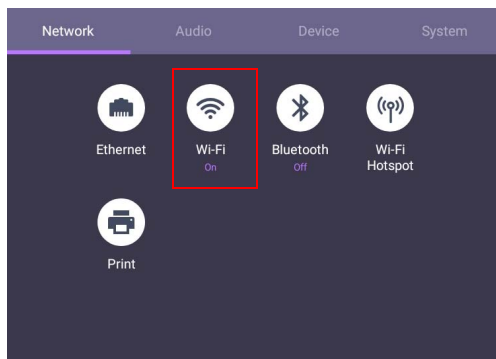

- Turn the switcher to **ON**. A list of available networks will show on the screen.



- Touch the network's name to connect to the network. The password is needed if it is your first time to use the network. Key in the password and press **Connect**. The product is now connected to the WLAN.



- If you are connecting to a secured wireless network, enter the password for the wireless network access when prompted and tap **Connect**.
- For wireless connection, BenQ shipment does not include wireless dongles; therefore, you may purchase it separately via the local dealer.

Proxy setting

- Go to **Network > Ethernet**.

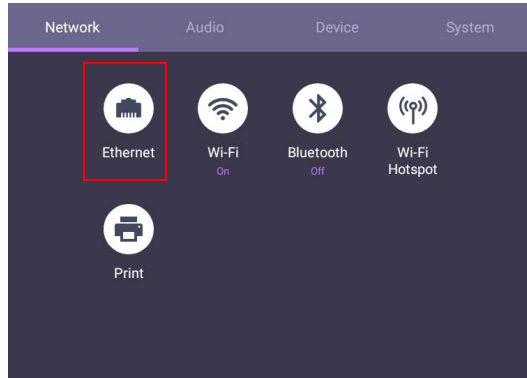

- Select **Proxy** to go to the proxy setting.

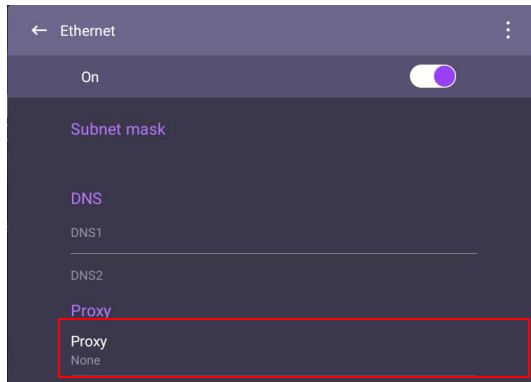

- Enter the proxy host name.
- Enter the using channel.

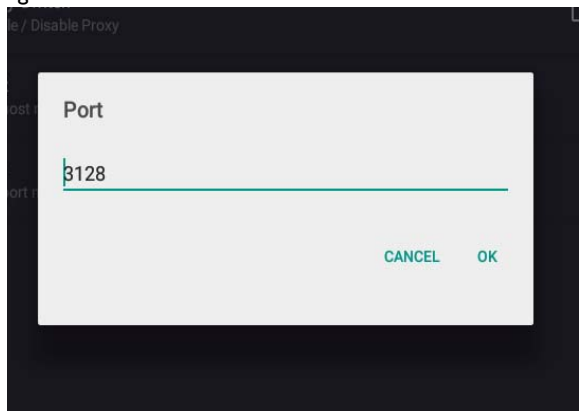

Adjusting audio volume level

To adjust the audio volume level, do either one of the following:

- Press **V+** / **V-** on the remote control to adjust the volume.
- Go to  > **Audio** to adjust the volume

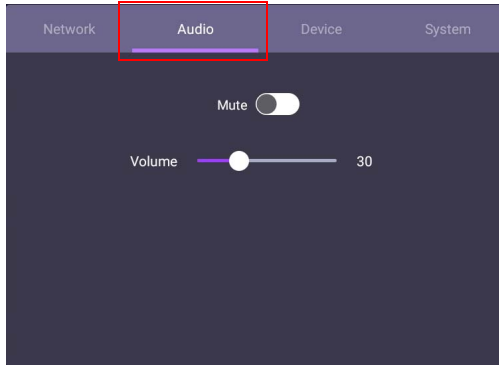

- Use the volume bar to adjust the volume for the display.
- Directly swipe  to enable or disable **Mute**.

Device settings

Go to **Device** to access the Device settings.

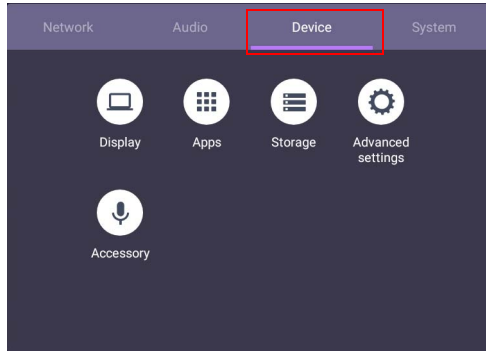

Menu	Description
Display	Allows you to adjust the display's parameters. Refer to Display settings on page 27 for more information.
Apps	Accesses all the applications installed in the product.
Storage	Allows you to manage the product's storage.
Advanced Settings	Accesses more device settings. Refer to Advanced settings on page 28 for more information.
Accessory	Allows you to set up the microphone, webcam and speaker.

Display settings

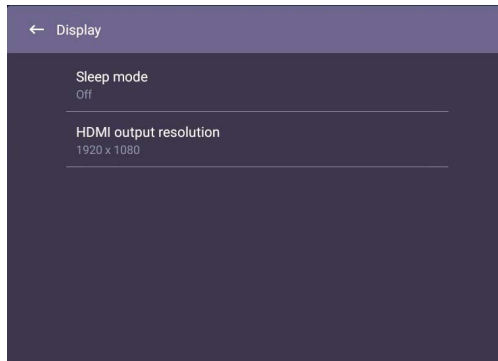

- Press **▲/▼/◀/▶** on the remote control and press **OK** to confirm or directly click an item.
- Press **⏪** on the remote control or click a blank area outside the menu to exit the menu.

Menu	Description
Sleep mode	Set up time interval to put HDMI OUT source in sleep mode when you're not using it.

HDMI output resolution	Set up HDMI OUT out resolution.
-------------------------------	--

Advanced settings

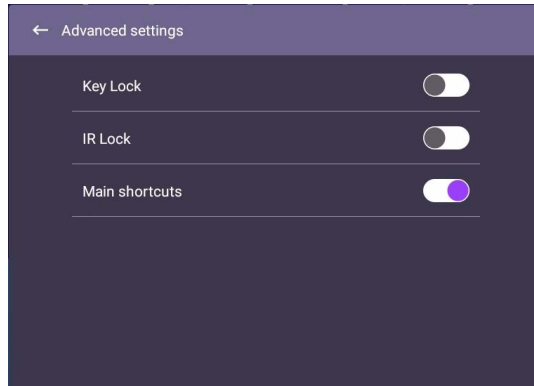

- Press **▲/▼/◀/▶** on the remote control and press **OK** to confirm or directly click an item.
- Press **↩** on the remote control or click a blank area outside the menu to exit the menu.

Menu	Description
Key lock	Press OK on the remote control or click the switch to lock or unlock the buttons on the front panel of the display.
IR lock	Press OK on the remote control or click the switch to lock or unlock the remote control IR sensor on the front panel of the display.
Main shortcuts	Press OK on the remote control or click the switch to enable or disable Main shortcuts .



If keypad and IR are locked all at once, please follow the steps to unlock: Press  on the remote control for five seconds.

System settings

On the home screen, select **Setting > System** to enter system settings.

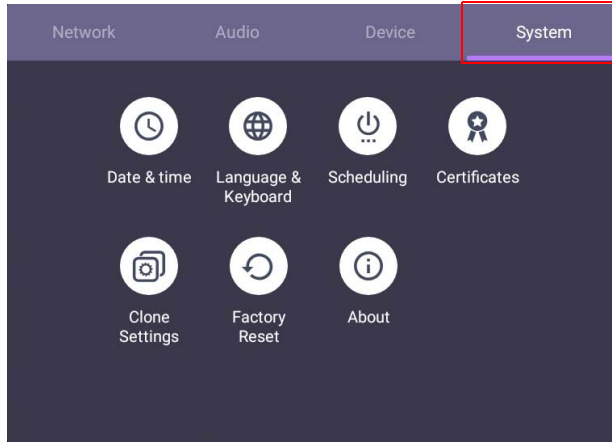

- Press  on the remote control or click a blank area outside the menu to exit the menu.



Options	Description
Date & Time	Click to set date, time, and their formats in Android.
Language & Keyboard	Click to set Language, Keyboard in Android.
Scheduling	Click to set the Power off reminder .
Clone settings	Click to export/import the settings.
Factory Reset	Click to erase all data back to default.
About	Click to view system information in Android.







The amount of available storage space for the user varies according to the amount of pre-installed apps and images occupying the total storage space.



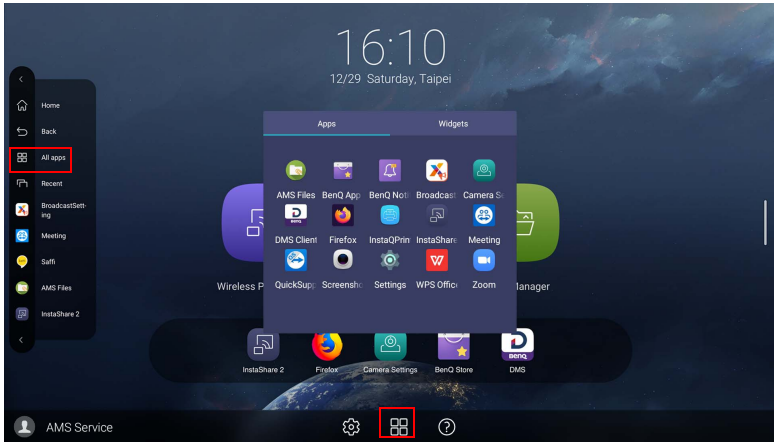

Apps

Two ways are provided for you to access all apps on the product:

1. Select  on the main screen to access the all apps window.
2. Press  on the remote control to open **Side Tool Bar** and select  to open the all apps window.



Application Name	Description
InstaShare 2 	Allows screen mirroring and touch control for collaborative meetings. Refer to Project wirelessly via InstaShare 2 on page 32 for more information.
TeamViewer Meeting 	Gives you access to instant or scheduled group meetings with any other TeamViewer Meeting users.
AMS files 	Provides you with personalized working environment and file management service. Refer to AMS file manager overview on page 34 for more information.
Camera Settings 	Adjusts camera settings and picture parameters. Refer to Camera settings on page 39 for more information.
BenQ App Store 	Allows you to download recommended apps. Refer to BenQ App Store on page 41 for more information.
X-Sign Broadcast 	Serves as a wireless broadcast system that allows immediate message delivery as well as group notification.
DMS Client 	Allows remote management, configuration, and monitoring of the display.

InstaQPrint ()	Allows you to print a file or website image using Wi-Fi or remote printer. Refer to InstaQPrint on page 42 for more information.
Firefox ()	Allows you to view websites.
WPS Office ()	Allows you to read PDF files or edit files created in Microsoft Office, PowerPoint, or Excel. Refer to WPS Office on page 43 for more information.
Saffi ()	Refer to Saffi on page 45 for more information.
Quick Support ()	Allows technicians to provide remote technical assistance.

Project wirelessly via InstaShare 2

InstaShare 2 (📺) is a software-based solution for multi-user collaboration, which lets users to share contents with all devices in a meeting wirelessly.

Two ways are provided for you to access **InstaShare 2**:

1. On the Android main interface, select **Wireless Projection** (📺).
2. Select **All Apps** (🗄️) > **InstaShare 2** (📺).

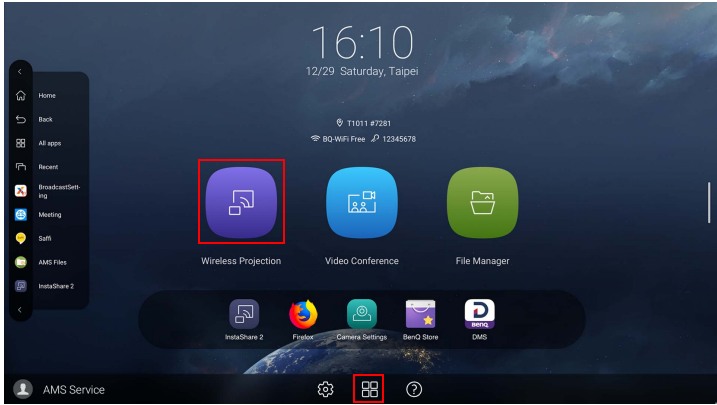

- Use mouse cursor to have a better user experience.
- Before launching the application, make sure your display is properly connected to the Internet.

When you enter **InstaShare 2**, the main interface is shown as below:



No.	Item	Description
1	Connection Tutorial window	Follow the guide to connect and pair your device with the display. Select the device OS type below to see the projection tutorial respectively.
2	Connecting Information window	Shows the display name, pairing code and connection password while presenting.

3	Host Controls window	Allows you to control the whole session and participant actions. You can also install InstaShare 2 app to manage the meeting session remotely
---	----------------------	--





Visit BenQ website or click the link below to view the complete user manual of **InstaShare 2** : <https://www.benq.com/en-us/business/ifp/instashare-2.html>

AMS file manager overview

With this application, you can access your personalized workspace environment and settings, and manage your files and accounts on any IFP that you have logged into.

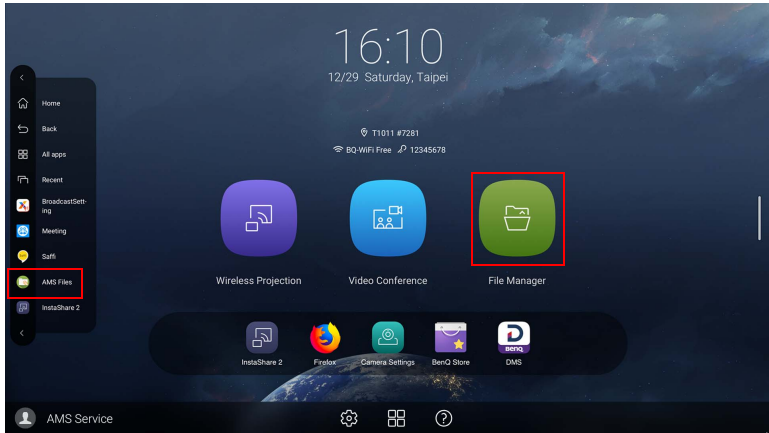

To access the AMS files use either of the following methods:

- On the Android main interface, select the file manager shortcut .
- Select the AMS application .

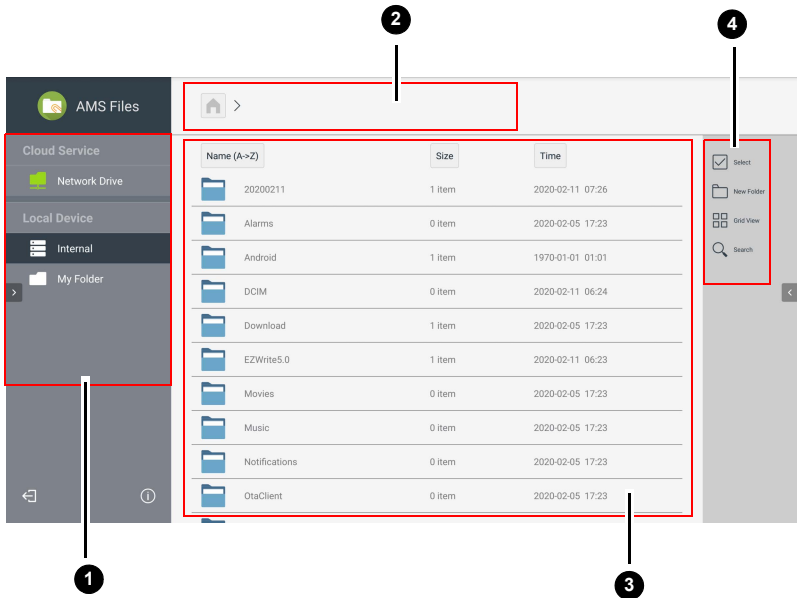

While logging in, you will see four main parts, as described in the table below:



No.	Item	Description
1	Source Selection	<ul style="list-style-type: none">You can open files from the cloud storage services like Google Drive, Dropbox, or Samba.You can also open files from the local devices like Internal, My Folder, or connected USBs. <p> The icon  next to Google Drive, Dropbox shows that the account is bound to AMS service.</p>
2	Folder Path	You can browse the file folder in this area.
3	Listing Files	You can see a list of files from the storage device you select.
4	Operating Tab	You can edit the files using the operating tabs here.
	Regular users can only view their own files, while the local admin can view all users' files in the domain.	









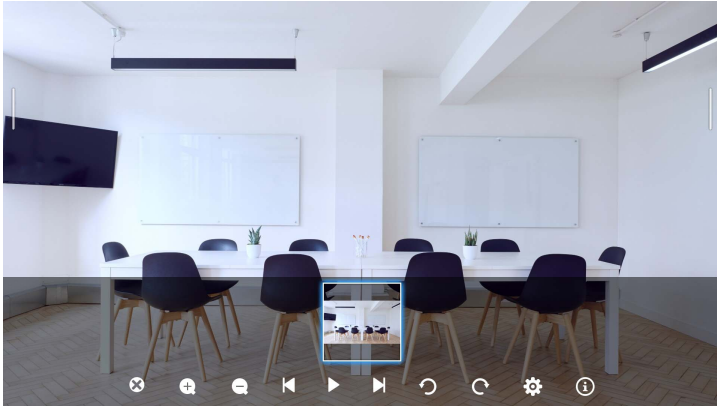

Multimedia files

Multimedia files such as images, audio files, and videos can be played by directly tapping on the file icon.

Image

Select an image file you want to show on the display and perform any of the functions shown on the screen.



Icon	Function
	Close the current image file.
	Magnify the current image.
	Shrink the current image.
	Play the previous image.
	Play/pause the current playback. You can set display intervals and animation in settings.
	Play the next image.
	Rotate the current image counter-clockwise.
	Rotate the current image clockwise.
	Adjust settings of the image such as setting display intervals and animation.
	Display the file information, including file name, creation time, file size, and file format.

Supported image format

File type	Resolution
JPEG, PNG, BMP	3840x2160

Audio/Video

Select an audio/video file you want to play on the display and perform any of the functions shown on the screen.



Icon	Function
	Tap to view the audio/video files in the playlist.
	Rewind the audio/video.
	Play the previous audio/video file.
	Play/pause the current audio/video file.
	Play the next audio/video file.
	Fast forward the audio/video.
	Adjust repeats, including repeat all/repeat one/no repeat.
	Adjust the audio/video volume.
	Adjust the size of you screen to Full/Half/Default/Mini.

Supported audio format

Audio Codec	Sample Rate	Bit Rate
MPEG1/2 Layer 1	16KHz - 48KHz	32Kbps - 448Kbps
MPEG1/2 Layer 2	16KHz - 48KHz	8Kbps - 384Kbps
MPEG1/2/2.5 Layer 3	8KHz - 48KHz	8Kbps - 320Kbps
AAC-LC, HEAAC	8KHz - 48KHz	AAC-LCz:12Kbps -576Kbps









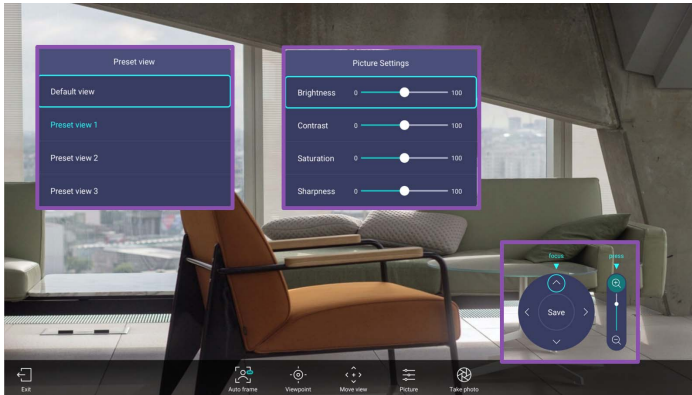



Supported video format

Video Codec	Resolution	Bit Rate
MPEG1/2	1080P @ 30 fps	30Mbps
MPEG4	1080P @ 30 fps	30Mbps
H.263	1080P @ 30 fps	30Mbps
H.264	4k2k @ 30 fps	100Mbps
H.265	4k2k @ 60 fps	100Mbps
VP8	1920x1080 @ 30fps	30Mbps
VP9	4k2k @ 60 fps	100Mbps

Camera settings

Tap  to launch **Camera Settings**. With this application, you can adjust different camera angles and picture parameters of the product.



Function	Description
Exit ()	Tap to close the application.
Auto frame ()	Tap to enable/disable auto framing. Under Auto frame mode, Viewpoint and Move view settings are locked.
Viewpoint ()	Allows you to choose a default or preset view for the camera. Besides the default view, you can preset three more views in Move view to accommodate different meeting environments. See Set and save a customized camera view on page 40 for more information.
Move view ()	Allows you to adjust the camera view and save it in Viewpoint . You can tap  /  to pan,  /  to tilt or  /  to zoom in and out.
Picture ()	Select to adjust picture settings including Brightness , Contrast , Saturation and Sharpness .
Take photo ()	Tap to screenshot the current camera settings.

Set and save a customized camera view

To set a customized camera view and save it for future use, follow the steps below:

1. Tap **Move view** (📷) in **Camera Settings** to adjust the camera angle.

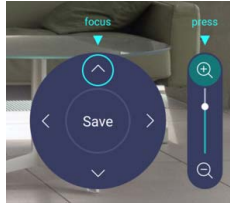

2. Press ▲/▼/◀/▶ on the remote control to pan or tilt the camera view. Press ⊕ / 🔍 on the remote control to zoom in and out.
3. After all adjustments are set, you can save the camera view to **Viewpoint** by tapping **Save** in the middle of the pan and tilt wheel.
4. In the **Save to preset** window, choose to save your settings in **Preset view 1/2/3**. Or select **Cancel** to discard current settings.



After the customized camera view is saved, go to **Viewpoint** (📷) to choose the desired **Preset view**.

BenQ App Store

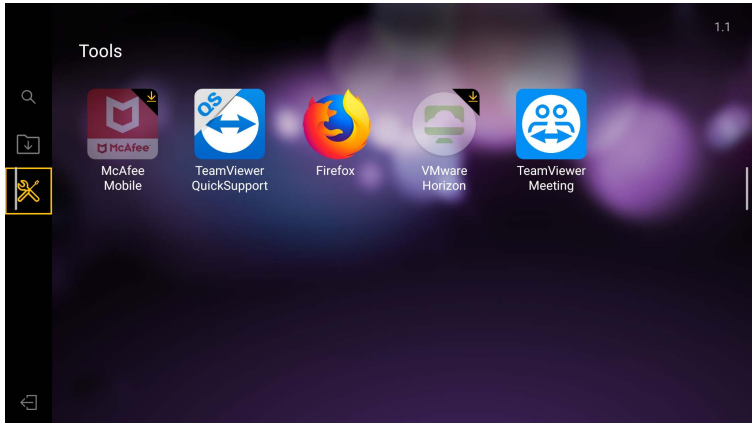
Tap  to launch **BenQ App Store**. BenQ App Store allows you to view and download recommended apps.



After **BenQ App Store** is launched, you can select the category on the left panel to browse the suggested apps. Select an app from the selected category to view the basic description of the app.

Function	Description
Search ()	Searches for an app.
Update Center ()	Allows you to update the BenQ App Store app.
Tools ()	Lists the available apps.

InstaQPrint

Tap  to launch **InstaQPrint**. With this application, you can print a file or website image using a Wi-Fi or remote printer.



- Before launching the application, make sure your display is properly connected to Internet.
- For the list of supported printers, see https://printhead.com/list_of_supported_printers.php.



1. Tap the option on the left panel and browse and select the desired file, photo, page, or image you want to print.
2. Tap **Manage Printers** to choose which printer that you want to use.
3. To select a printer:
 - Tap an option from the list of available printers on the left panel.
 - Tap **Scan for Wi-Fi Printers** to search for printers automatically.
 - Tap **Manual Setup** to add a new printer manually.

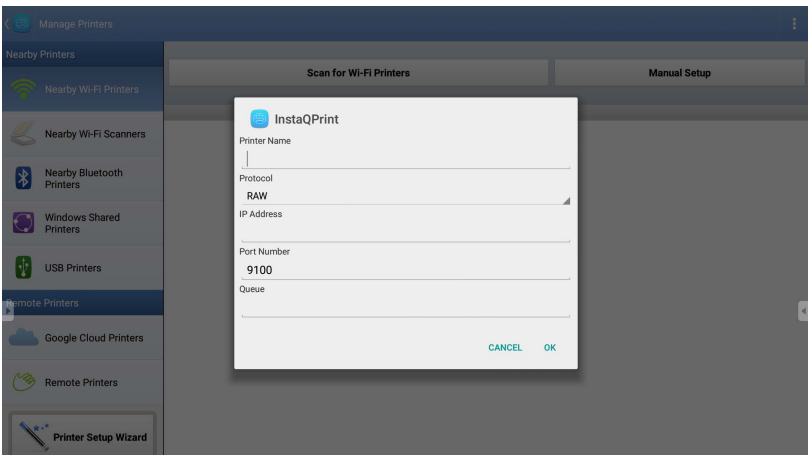

WPS Office

Tap  to launch **WPS Office**. With this application, you can open document files including PDFs as well as Microsoft Word, PowerPoint and Excel documents.

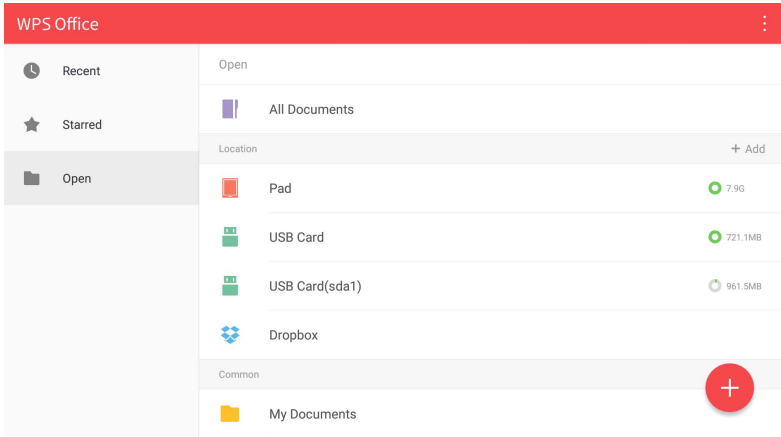

To edit a file with **WPS Office**:

1. Tap **Open** () on the left panel to browse and open a file located in either the display's internal memory, an external storage device, or cloud storage.
2. Tap the function menu on the top panel to access the file format's various functions.



The description below is for a PowerPoint file, the function menus for other file formats will vary.

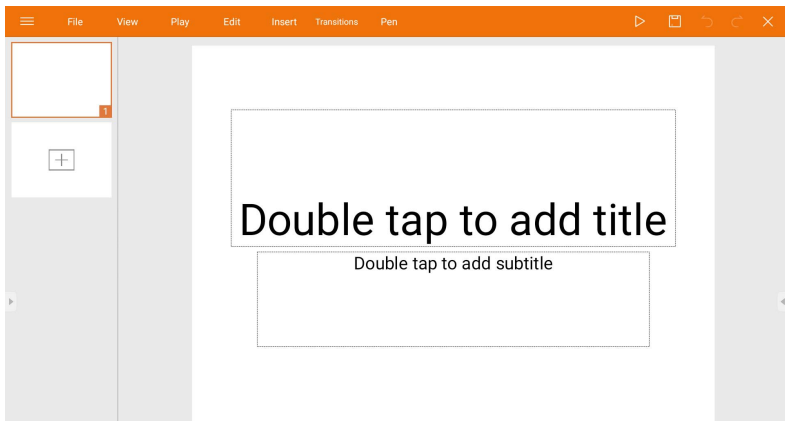

Function	Description
File	Tap to open, save, share, print, and manage your presentations.
View	Tap to change or edit the presentation views.
Play	Tap to start or set up a slide show.

Edit	Tap to edit the content or format of the slides.
Insert	Tap to insert tables, pictures, charts, comments, video, or audio.
Transitions	Tap to apply or adjust the timing of a transition.
Pen	Tap to write, draw, paint or sketch to the slides.
Play (▷)	Tap to start a slide show.
Save As (📁)	Tap to save the presentation file on either the display's internal memory, an external storage device, or cloud storage.
Undo (↶)	Tap to undo an action.
Redo (↷)	Tap to redo the last action.
Close (✕)	Tap to close the presentation file.
Back (←)	Tap to return to the previous page.
Next (→)	Tap to go to the next page.
Exit (⏏)	Tap to exit WPS Office .

Supported Office versions and file formats

Supported Office versions: 97 / 2000 / XP / 2003 / 2007 / 2010 / 2013 / 2016

Supported Office software formats:

Office Software	Supported File Formats
Word	wps / wpt / doc / docx / dot / dotx / txt / log / irc / c / cpp / h / asm / s / java / asp / bat / bas / prg / cmd
Excel	et / ett / xls /xlsx / xlt / xltx / csv / xlsx / xltm
PowerPoint	ppt / pptx

Saffi

How to start using Saffi – BenQ Voice Assistant

The product offers an extra level of flexibility for device control through Voice Assistant. Voice Assistant lets users control the flow of meetings by allowing them to start timers or search the Internet from anywhere in the room.

Already enable AMS service but did not bind your Amazon account to it

If you already enable Multi Account Mode and AMS service and you have not yet bind your Amazon account to it, please follow the below steps:

1. Access AMS website to link the account with Amazon. For more detail on how to link the account under AMS, please refer to AMS user manual.

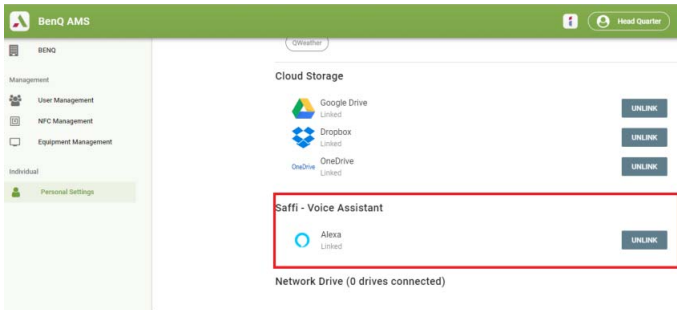

2. Press the Voice command key to activate Saffi.

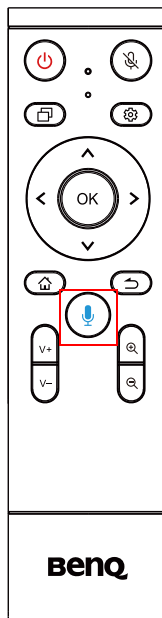

3. The screen will show the privacy agreement. Select **AGREE AND NEXT** to proceed.

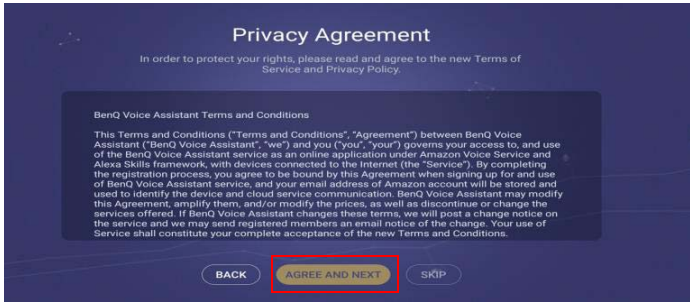

4. It will then show the instruction for the setup. Follow the instruction on the screen to complete the setup.

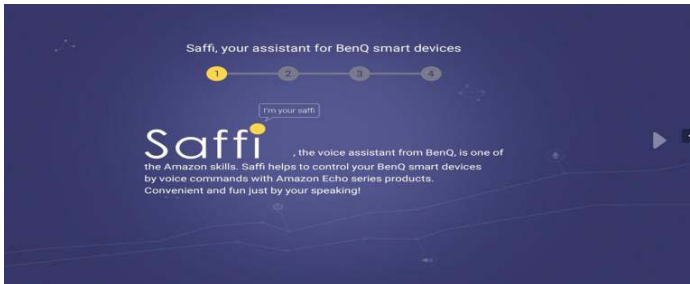

5. Download and install Alexa app on your phone. Search Saffi and enable it.

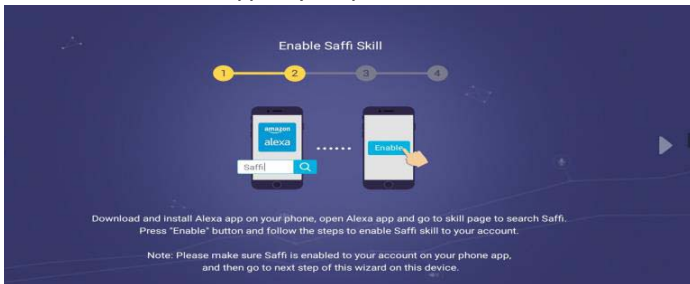

6. The setup is completed. Press the Voice command key and speak the commands to start using Saffi.

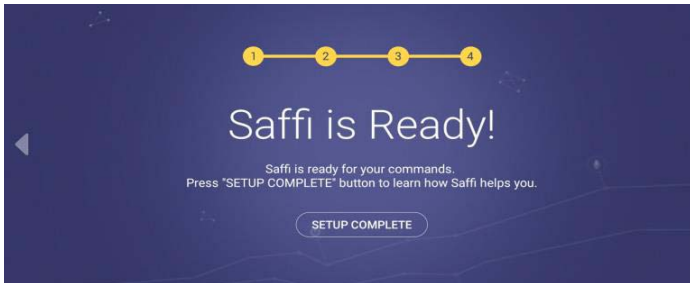

Product information

Specifications

Item		Specifications
		VC01A
Camera	Pixel	12 million pixels
	Resolution & Frame Rate	H.264/MJPEG: 3840×2160 / 2560×1440 / 1920×1080 / 1280×720 / 1024×576 / 960×540 / 800×600 / 640×480 / 640×360 / 480×270 / 352×288 / 320×240 / 320×180 / 176×144 / 160×120 / 160×90
		YUV2: 640×480 / 640×360 / 480×270 / 352×288 / 320×240 / 320×180 / 176×144 / 160×120 / 160×90
		Output Format
	Field of View (FOV)	DFOV: 120° (Diagonal)
	Adjustable Angle	±15° (Manual)
	Focus Mode	Fixed Focus
	Focus Distance	0.5m
	Digital Zoom	x5
	Camera Presets	3
Auto Framing	Yes	
Microphone	Array Microphone	x6
	Voice Pickup Range	0~8 m
	Beamforming	Yes
	Noise Reduction	Yes
	Echo Cancellation	Yes
	Voice Localization	Yes
	Auto Gain Control (AGC)	Yes
Speaker	Number of Speaker	x1
	Output Power	8W
	Sound Channel	1
	Automatic Level Control (ALC)	Yes
System	OS	Android 9.0
	OS Requirements (BYOD Mode)	Win10/Win8/Win7/Win XP/Linux OS/Mac OS/Chrome OS
	Memory	4GB
	Storage	16GB

Item		Specifications
		VC01A
I/O Connection	USB 2.0 Type-C	x1 (serve as device)
	USB 3.0 Type-A	x1
	Audio in/out (AUX)	x1
	HDMI out	x1
	RJ45	x1 (10M/100M)
	DC-in 2.0	x1
Wi-Fi & Bluetooth	Wi-Fi	Wi-Fi (802.11 a/b/g/n/ac/ax) 2.4G/5G
	Bluetooth	Bluetooth 5.0
Power	Power Requirements	12V/3A (Adapter)
	Power Consumption (max.)	36W
	Stand by	≤0.5W
Mechanical	Dimension (WxHxD)	462 x 76 x 93 mm
	Dimension w/ pack (WxHxD)	540 x 160 x 170 mm
	Net Weight	1.0 kg
	Gross Weight	2.3 kg
Environmental Conditions	Operation Temp (°C)	0°C ~ 40°C
	Storage Temp (°C)	-20°C ~ 60°C
	Storage Humidity	10% ~ 90% RH Non-Condensing
	Operating Humidity	10% ~ 90% RH Non-Condensing
	Altitude	Below 5000 meters
Accessory	Remote Control	x1
	Adaptor / Plug	x5 (US/EU/AU/KR/UK)
	HDMI cable	x1 (1.5m)
	USB Type-C cable	x1 (3m)
	Camera cover	x1
	QSG	x1



- OS: This Android 9.0 operating system is not standard Android, so access to Google Play™ is not available. APK cannot be installed in the default location. Without management permission, installing function won't work. There is no guarantee that the self-installed APK can function normally.
- Storage: Content storage may vary by the product supplied for your region. Pre-installed system and apps may take up some space.

Dimensions

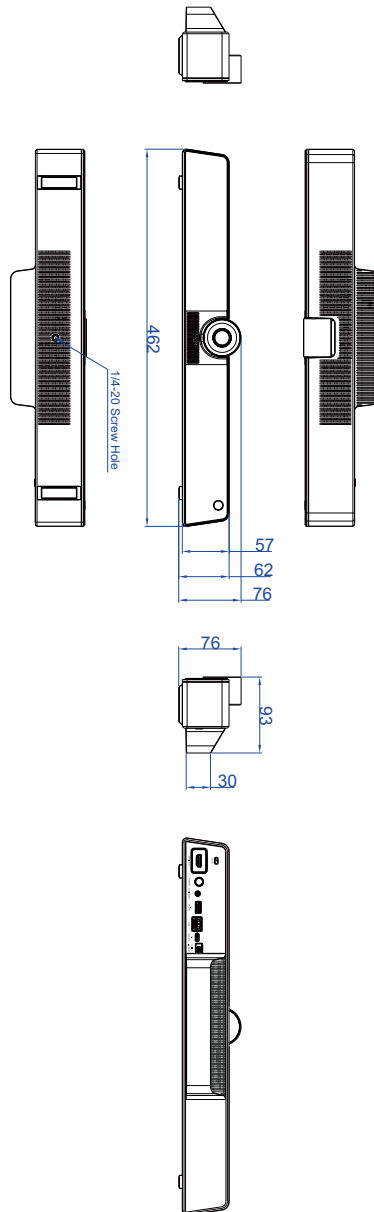

Unit: mm

Troubleshooting

Problem	Solution
No picture	Check the following: <ul style="list-style-type: none"> • Is the display turned on? Check the power indicator of the display. • Is your product turned on? Turn on the product and try again. • Are there any loose cable connections? Make sure that all cables are connected firmly.
No sound	Check the following: <ul style="list-style-type: none"> • Have you turned on the mute function? Turn off the mute function or increase the audio volume level and try again. • Are there any loose cable connections? Make sure that all cables are connected firmly.
The remote control does not work	<ul style="list-style-type: none"> • Check for incorrect battery orientation. • Check for dead batteries. • Check your distance and angle from the product. • Check whether remote control is properly being pointed at the receiver. • Check for any obstacle between the remote control and the receiver. • Check that the receiver is not under strong fluorescent lighting, or in direct sunlight. • Check for any devices (computer or personal digital assistant, PDA) nearby that transmit infrared signals which may cause interference to signal transmission between the remote control and the display. Turn off the infrared function of these devices.