

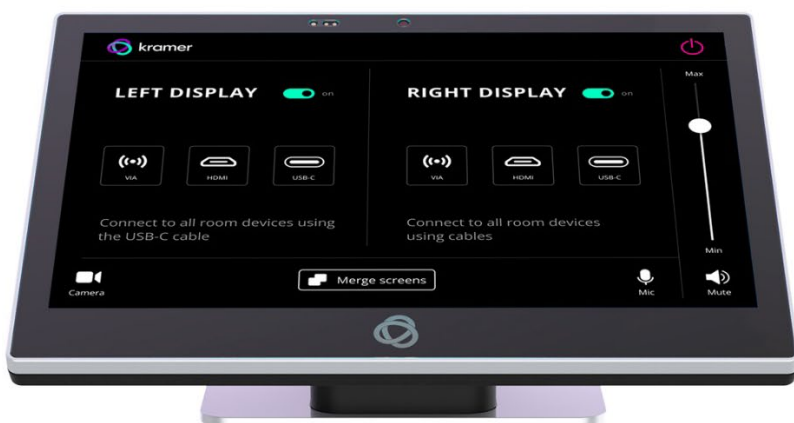

# USER MANUAL

## MODEL:

**KT-2010-Gen2**  
**10" Touch Panel**



# Contents

<b>Contents</b>	<b>2</b>
<b>Introduction</b>	<b>3</b>
Getting Started	3
Overview	5
Typical Applications	6
<b>Defining KT-2010-Gen2 10" Touch Panel</b>	<b>7</b>
KT-2010 Tabletop Mount	8
KT-2010-Gen2 On-Wall Mount	8
<b>Mounting the KT-2010-Gen2</b>	<b>9</b>
Mounting KT-2010-Gen2 on a Table	9
Mounting KT-2010-Gen2 on a Wall	11
Connecting Options	13
<b>Controlling KT-2010-Gen2</b>	<b>14</b>
Using Navigation Buttons or Gestures	14
Using the Home Page	15
Exiting or Starting the Kramer Control app	15
<b>Basic Settings of KT-2010-Gen2</b>	<b>16</b>
Essential First Steps	16
Setting the Date and Time	16
Connecting to Wi-Fi or Ethernet	17
Installing an 802.1X Certificate	18
Changing the Automated Firmware Update	19
Changing the Automated Kramer Control agent update	21
Setting the Display and Keyboard Language	22
For more information about using the K-agent App please refer to the K-agent User-guide	23
<b>Advanced Settings</b>	<b>24</b>
Scheduling a Daily Reboot	24
Password Protecting Device Settings	24
Factory Reset & Reboot	25
Logging Activity	25
Defining an auto-start playlist	26
Modifying Display Settings	27
Switching to Native Android Mode	27
<b>Technical Specifications</b>	<b>28</b>

# Introduction

Welcome to Kramer Electronics! Since 1981, Kramer Electronics has been providing a world of unique, creative, and affordable solutions to the vast range of problems that confront the video, audio, presentation, and broadcasting professional on a daily basis. In recent years, we have redesigned and upgraded most of our line, making the best even better!

---

## Getting Started

We recommend that you:

- Unpack the equipment carefully and save the original box and packaging materials for possible future shipment.
- Review the contents of this user manual.



Go to <http://www.kramerav.com/downloads/KT-2010GEN2> to check for up-to-date user manuals, application programs, and to check if firmware upgrades are available (where appropriate).

## Achieving Best Performance

- Use only good quality connection cables (we recommend Kramer high-performance, high-resolution cables) to avoid interference, deterioration in signal quality due to poor matching, and elevated noise levels (often associated with low quality cables).
- Do not secure the cables in tight bundles or roll the slack into tight coils.
- Avoid interference from neighboring electrical appliances that may adversely influence signal quality.
- Position your Kramer **KT-2010-GEN2** away from moisture, excessive sunlight and dust.

## Recycling Kramer Products

The Waste Electrical and Electronic Equipment (WEEE) Directive 2002/96/EC aims to reduce the amount of WEEE sent for disposal to landfill or incineration by requiring it to be collected and recycled. To comply with the WEEE Directive, Kramer Electronics has made arrangements with the European Advanced Recycling Network (EARN) and will cover any costs of treatment, recycling and recovery of waste Kramer Electronics branded equipment on arrival at the EARN facility. For details of Kramer's recycling arrangements in your particular country go to our recycling pages at <https://www.kramerav.com/social-responsibility/environment/>.

## Safety Instructions

This unit is intended to be supplied by:

- IEC 62368-1 certified PoE output power supply suitable for use at an ambient temperature of 40°C and altitude of 5,000 m whose output meets ES1, and is rated 44-57V DC, minimum 0.6 A.
- IEC 62368-1 certified Class II power adapter suitable for use at an ambient temperature of 40°C and altitude of 5,000 m whose output meets ES1, and is rated 12V DC, minimum 1.5 A.



### Caution:

- This equipment is to be used only inside a building. It may only be connected to other equipment that is installed inside a building.
- For products with relay terminals and GPIO ports, please refer to the permitted rating for an external connection, located next to the terminal or in the User Manual.
- There are no operator serviceable parts inside the unit.
- Risk of explosion if the battery is replaced by an incorrect type. Wait one-half hour after switching off before handling parts.



### Warning:

- If not using PoE, use only the optional power cord that is supplied for the unit.
- Do not open the unit. High voltages can cause electrical shock! Servicing by qualified personnel only.



### Laser Safety:

- This product complies with FDA performance standards for laser products except for conformance with IEC 60825-1 Ed. 3., as described in Laser Notice No. 56, dated May 8, 2019.
- Date of manufacture: The date code at the bottom of the product label represents the manufacturing date of this laser product.



**Caution:** Invisible laser radiation when open. Avoid exposure to beam. Class 1 laser product. This system must be opened only by qualified technicians to prevent accidents caused by the laser beam.

**Caution:** Use of controls or adjustments or performance of procedures other than those specified herein may result in hazardous radiation exposure.

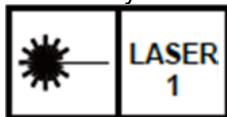

The ambient light sensor can automatically adjust panel brightness based on the environment. See Display Settings to enable automatic brightness.

The Laser proximity sensor will detect nearby motion to wake the panel up without requiring a touch.

---

## Overview

Congratulations on purchasing your **Kramer KT-2010-Gen2 10" Touch Panel**.

**KT-2010-Gen2** is a new powerful, 10-inch, IPS, multi-touch, touch panel with 1920x1200 resolution. Elegantly designed for decorative room integration, this portable touch panel can be deployed either on a tabletop or wall.

**KT-2010-Gen2**, with the latest Android 13, supports wired PoE (Power over Ethernet) and advanced Wi-Fi connectivity options. The touch panel has a built-in speaker and camera and comes either with a tabletop or a wall mount. The touch panel is easy to assemble, using elegant wiring, secured mounting, reliable operation and flexible deployment.

**KT-2010-Gen2** is a touch panel that is ideal for any 24/7 Kramer-supported commercial AV or control application and features a user-friendly, fully customizable graphical user interface configured by Kramer software.

## Exceptional Quality

- **Elegant Design** – Smooth integration with room furniture, either on tables or walls, with flexible panel cabling and locking design options.
- **Superior User Experience** – IPS 1920x1200 hi-resolution screen with  $\pm 80^\circ$  horizontal and vertical wide viewing angles, built-in lighting sensor for auto-adaptable brightness, and advanced multi-touch points and 2-finger gesture capabilities.
- **Powerful Processing** – Genio 510 Hex Core CPU, 4GB RAM, 32GB ROM processing performance, smoothly running Kramer Control & Session Manager user Interfaces.
- **Flexible Services** – Latest Android 13 operating system. Advanced and User-friendly Operation
- **Easy Installation** – Powering and connectivity via a single Ethernet cable.
- **Flexible Mounting** – Including table & wall mounts.
- **Optional Connectivity** – Simple wireless Bluetooth 5.2 as well as connection to USB peripheral devices for either table or wall-mount installations, using the included USB cable.
- **Reliable Networking** – Seamless switching between wired or WiFi 6 connectivity.
- **Versatile Powering Options** – PoE and power adapter (sold separately).
- **Auto Sensing** – Optimized performance and operation according to automatically detected LAN speed.
- **Firmware Upgrade** – Define automatic updates on a predefined time of the day or update manually using USB port.

## Security

- Secured Operation – Highly secured operation of applications using password protection, hidden control buttons and more. Red LED alert when camera is active.
- Secured Deployment – Locking options to prevent unwanted panel-mount removal, elegantly designed to remain out of site.

---

## Typical Applications

The **KT-2010-Gen2** is ideal for the following typical applications:

- Control user interface in meeting and conference rooms, boardrooms, and auditoriums.
- Presentation of room scheduling.

# Defining KT-2010-Gen2 10" Touch Panel

This section defines KT-2010-Gen2.

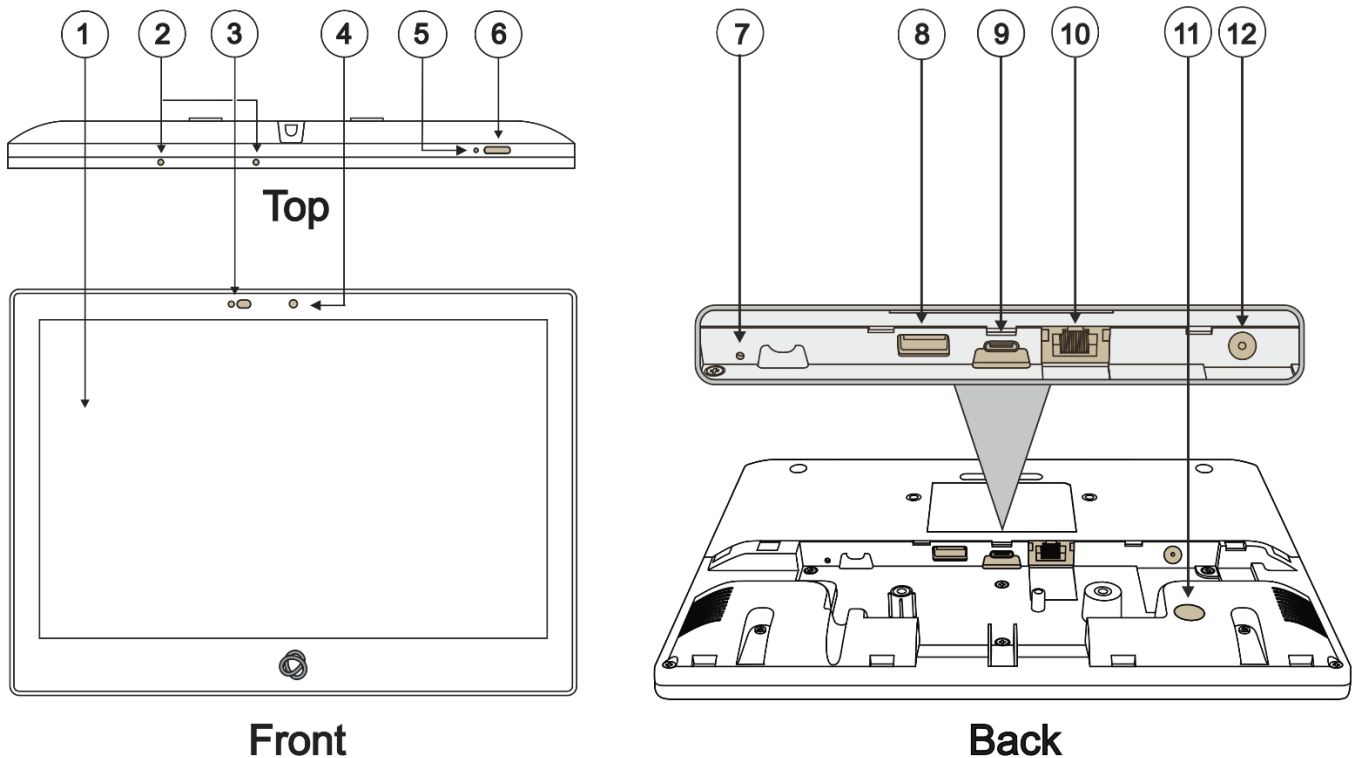

Figure 1: KT-2010-Gen2 10" Touch Panel

#	Feature	Function
①	Display	Touch panel
②	Microphone	For audio communication, recording or conferencing.
③	Proximity Sensor	Automatically adjusts the screen brightness and camera according to the room lighting conditions.
④	Camera	For remote room viewing or video conferencing.
⑤	Reset	Located on the topside. Insert a pin and hold for a few seconds to restart.
⑥	Home Button	Press to wake up / darken the screen.
⑦	Restore Factory Reset Button	Insert a pin and hold for 22 seconds to reset the device to factory default values.
⑧	USB 2.0 Port	Multipurpose port for external connection.
⑨	USB Type-C Port	Multipurpose port for external connection.
⑩	LAN 1G(PoE) RJ-45 Port	Connect to the LAN for network communication. KT-2010-GEN2 are powered by PoE (power over ethernet) delivered through the LAN port. Optionally, you can connect the power adapter too (as backup).
⑪	Kensington Lock	Anti-theft security slot for locking the device.
⑫	12V/2A DC Connector	Connect to the power adapter (optional, purchased separately).

## KT-2010 Tabletop Mount

This section defines the KT-2010-Gen2 tabletop mount.

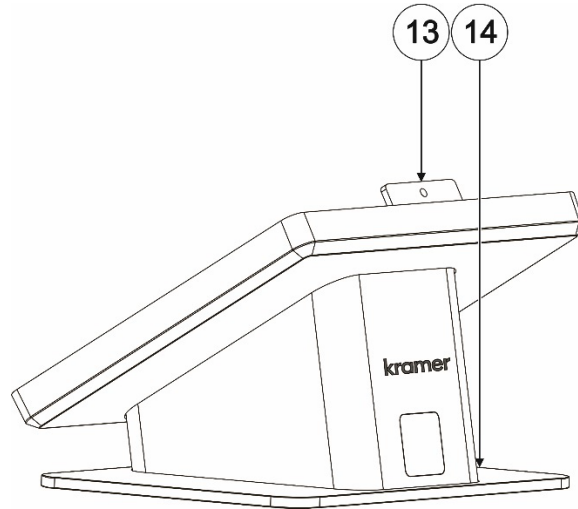

Figure 2: Tabletop Mount Rear View

#	Feature	Function
13	Screw Opening	For securing the 10" Touch Panel to the tabletop mount using the supplied M3 screw.
14	2 x 5/32" Screw Opening	Optional: For safely securing the tabletop mount to the table from underneath.

## KT-2010-Gen2 On-Wall Mount

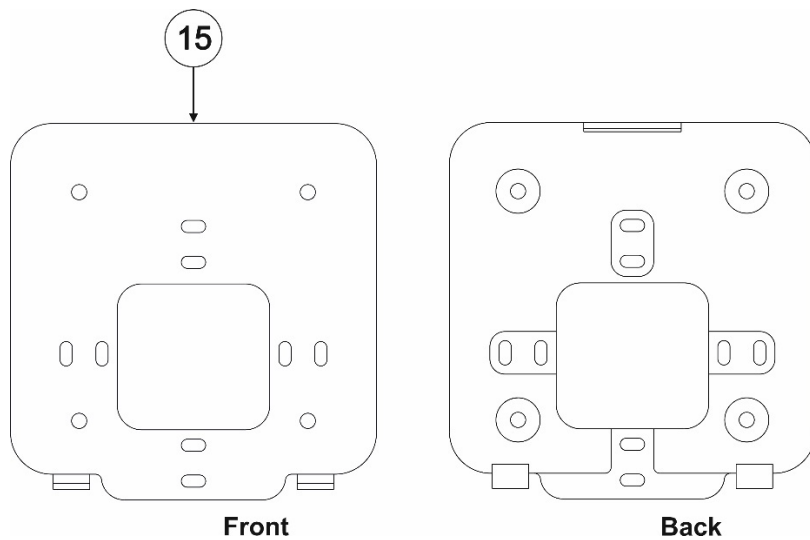



Figure 3: Wall mount bracket

#	Feature	Function
15	Wall mount bracket	For securing the 10" Touch Panel to the wall mount bracket using the supplied M3 screw. For measurements see the image in <a href="#">Mounting KT-2010-GEN2 on a Wall</a> on page 11.



# Mounting the KT-2010-Gen2

The KT-2010-Gen2 package include everything required for mounting the touch panel on a table or on a wall.

 Always be careful when attaching or removing the 10" Touch Panel from a mount.

## Mounting KT-2010-Gen2 on a Table

Mount KT-2010-Gen2 on a table using one of the following options:

- **Moveable Mount:** Place the tabletop mount on the table. Connected cables remain visible and the table remains intact.
- **Secure Mount:** Bolt the tabletop mount into the table. Connected cables are hidden through a hole in the table.

### Moveable Mount

1. Remove the I/O cover:
  - Take out the 2 M2 screws.
  - Insert fingers into the two slots and slide the cover down.
2. Connect any necessary cables, running them through the table stand to the KT-2010-GEN2.
3. Replace the I/O cover, taking care to prevent pressure on the RJ-45 cable:
  - Use a cable without a hood.
  - Curl the cable under the cover.
4. Close the cover with the 2 M2 screws.
5. Lay the KT-2010-Gen2 face-down and mount the table stand on it.
6. Insert and fasten the provided M3 screw that secures the bottom of the KT-2010-Gen2 to the table stand (see 12 in [KT-2010 Tabletop Mount](#) on page 8).

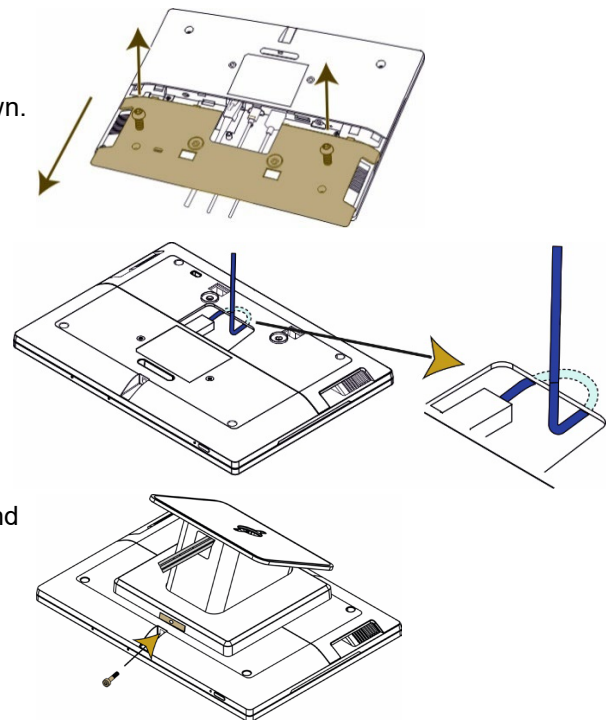

The table stand and touch panel are now ready for use.

## Secure Mount

If you want to pass cables from underneath, you may need to cut an opening in the table.

1. Remove the I/O cover:
  - Take out the 2 M2 screws.
  - Insert fingers into the two slots and slide the cover down.
2. Connect any necessary cables, running them through the table stand to the **KT-2010-Gen2**.
3. Replace the I/O cover, taking care to prevent pressure on the RJ45 cable:
  - Use a cable without a hood.
  - Curl the cable under the cover.
4. Close the cover with the 2 M2 screws.

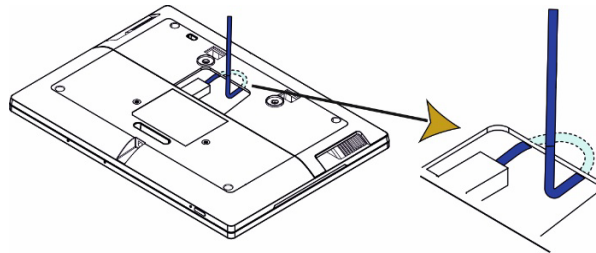
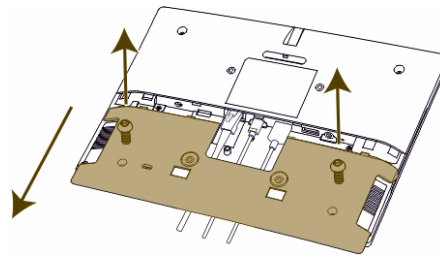

5. Lay the **KT-2010-Gen2** face-down and mount the table stand on it.
6. Secure the stand to the table using the two provided 5/32" screws (see 13 in [KT-2010 Tabletop Mount](#) on page 8).
7. Mount the **KT-2010-Gen2** on the stand and secure it with the provided M3 screw (see 12 in [KT-2010 Tabletop Mount](#) on page 8).

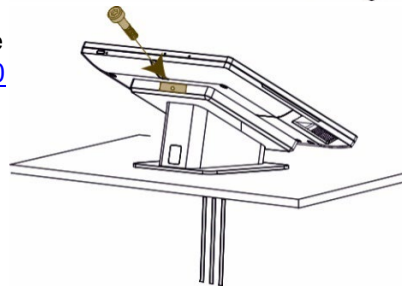
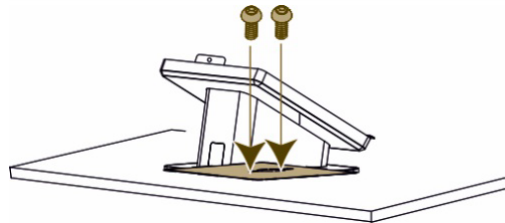

The table stand and touch panel are now ready for use.

## Mounting KT-2010-Gen2 on a Wall

Install KT-2010-Gen2 safely on a wall using a standard single Gang in-wall junction box. The cables are passed inside the wall and then connected to the rear side of the on-wall mount unit.

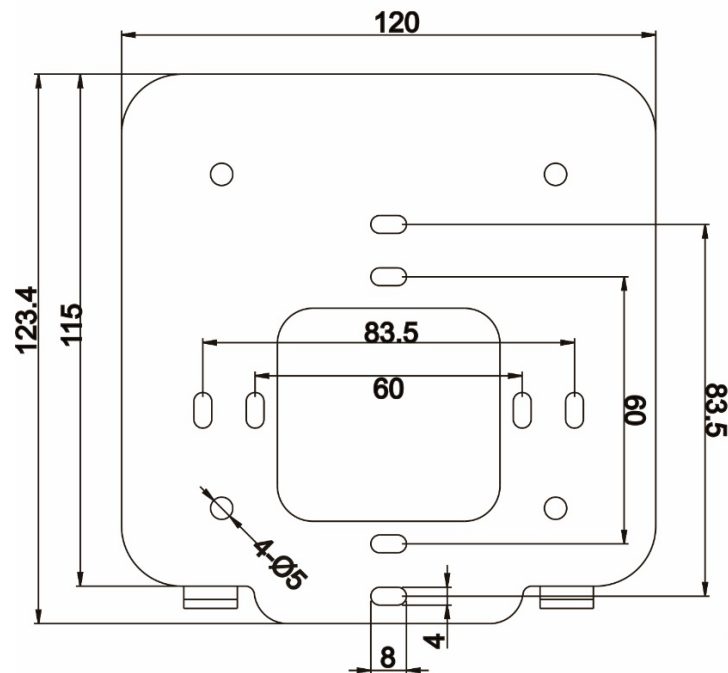

Figure 4: The on-wall mount's measurements

## Inserting the On-Wall Mount Unit

To mount the device on a one-gang box:

1. Remove the I/O cover:
  - Take out the 2 M2 screws.
  - Insert fingers into the two slots and slide the cover down.
2. Connect any necessary cables to the KT-2010-Gen2 wall mount.
3. Replace the I/O cover, and close with the 2 M2 screws.
4. Click the wall bracket (see 15 in [KT-2010-GEN2 On-Wall Mount](#) on page 8) onto the back of the I/O cover (push the bracket into place while holding its top slightly outward).

**Note:** The bracket may look slightly different and have additional screw holes.

5. Secure the wall bracket to the touch panel cover using the M3 screw.

The touch panel is mounted.

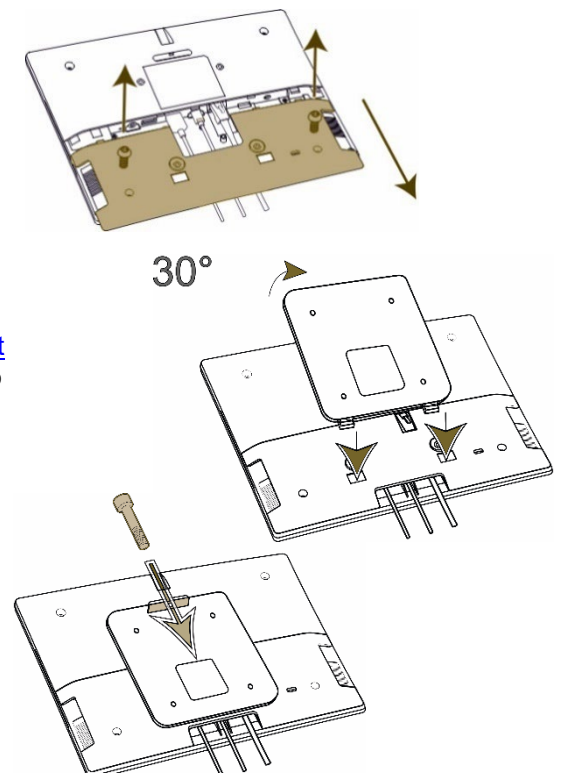

**To mount the device on a secured wall bracket:**

1. Mount the wall bracket (15 in [KT-2010-Gen2 On-Wall Mount](#) on page 8) on the installation point (screws not provided).

The bracket may have additional screw holes not shown here.

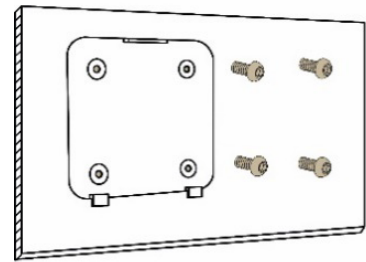

2. Connect the touch panel to the wall bracket (lift it into place while holding the top of the touch panel slightly outward).

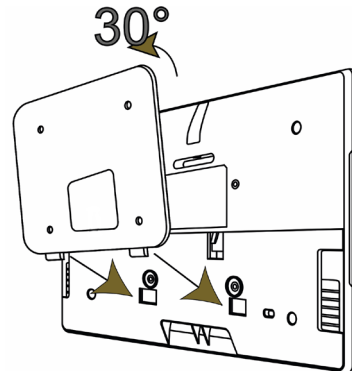

3. Use the provided M3 screw to secure the touch panel to the wall bracket and back cover.

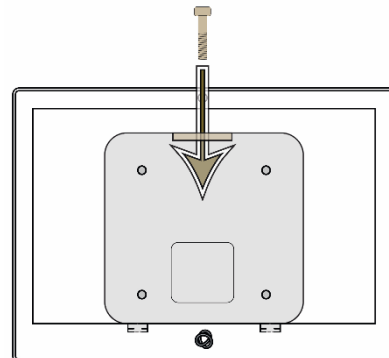

The touch panel is mounted. ([Figure 5](#))

## Connecting Options

You can power the KT-2010-Gen2 using any or all of the following options:

1. Connect the PoE-enabled LAN RJ-45 connector to your local area PoE-enabled network.
2. Connect the power adapter to the 12V DC connector on the rear side. The DC power supply is optional: It can be purchased separately.

 When both PoE and the power supply are connected to the Touch Panel, the unit is powered by the power supply.

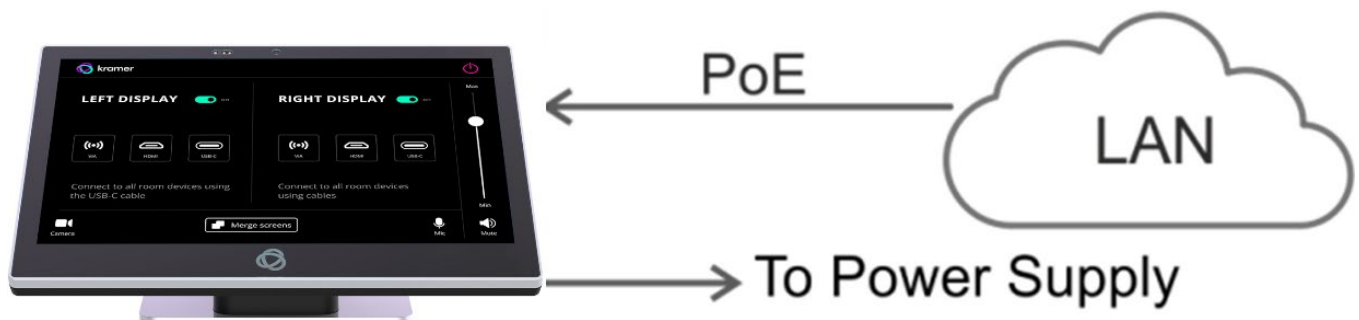

Figure 5: Powering the Touch Panel

# Controlling KT-2010-Gen2

## Using Navigation Buttons or Gestures

By default, **KT-2010-Gen2** run the K-Agent app and displays its config screen at start-up. If available, you can use the navigation buttons displayed at the bottom of the screen. You can also set up your device to use gestures-based navigation.

### Using navigation buttons

Swipe a finger upwards from the line at the bottom of the screen and release to see the navigation buttons:

- ◀ - **Back** – Returns to the previous screen (or opens the home page if there is none).
- - **Home** – Opens the home page, see [Using the Home Page](#) on page [15](#).
- - **Recent apps** – Scroll between the active apps.

### Changing the navigation system

By default, navigation buttons are used, however the touch panel can be set up to use navigation gestures instead. To change the navigation method:

1. On the Home page, press **Settings** . The device's **Settings** menu opens.
2. Select **Advanced settings > System**.
3. In the System menu, press **Gestures** and then **System navigation**.
4. Select **Gesture navigation** or **3-button navigation**. If you are using Gesture navigation, the sensitivity is adjustable.

### Using Gesture navigation

- **Back** – Drag a finger inwards from the left or right edge of the screen.
- **Home** – Swipe a finger upwards from the line at the bottom of the screen and release.
- **Recent apps** – Swipe a finger upwards from the line at the bottom of the screen and hold.

### Hiding the Navigation Bar

To hide/unhide the navigation bar:

1. On the Home page, press the **Settings** button . The device's **Settings** menu opens.
2. In the Settings menu, open **Player settings** and enable **Fullscreen mode**.

---

## Using the Home Page

Swipe a finger upwards from the Kramer logo at the bottom of the screen and release to see the navigation buttons. A PIN may be required (default 9428).

- - **Home** – Opens the home page.

The Home page contains the following icons:



- Chromium browser



- Touch panel settings



- Kramer Control agent

---

## Exiting or Starting the Kramer Control app

KT-2010-Gen2 come with a **Kramer Control agent** (icon ) pre-installed app. The role of this app is to display an interface that you defined in Kramer Control.

When the touch panel starts, the Kramer Control agent runs automatically. To exit the Kramer Control agent, enter the PIN (default 9428). If the PIN button is not displayed, swipe up from the Kramer icon at the bottom of the screen to bring up the PIN entry pop-up.

To re-open the Control Agent click the  icon on the Home page.

During initial installation the k-agent app may need to be started manually the first time.

# Basic Settings of KT-2010-Gen2

---

## Essential First Steps

To exit the Kramer Control agent, enter the PIN (default 9428). If the PIN button is not displayed, swipe up from the bottom of the screen to bring up the PIN entry pop-up.

To open the Control Agent click the  icon on the Home page.

The following are essential first steps in using the touch panel:

1. **Set the device date and time;** [Setting the Date and Time](#) on page [16](#).
2. **Setup the Ethernet and/or Wi-Fi connections;** [Connecting to Wi-Fi or Ethernet](#) on page [17](#).
3. **Consider changing the time that the system checks for firmware (OS) updates;** [Changing the Automated Firmware Update](#) on page [19](#). By default, this is set to midnight, change it if you have no internet access at midnight or prefer another time.
4. **Consider changing the time that the system checks for Kramer Control (APK) updates;** [Changing the Automated Kramer Control agent update](#) on page [21](#). By default, this is set to midnight, change it if you have no internet access at midnight or prefer another time.
5. **Setup the Kramer Control agent's Launch URL;** See [For more information about using the K-agent App please refer to the K-agent User-guide](#) on Page [23](#).

---

## Setting the Date and Time

The device arrives preset to New York time and you will need to set the correct time region.

To adjust the date and time settings:

1. If necessary, swipe up from the bottom of the screen to bring up the PIN entry pop-up and enter the PIN (default 9428).
2. On the Home page, press the **Settings** button . The device's **Settings** menu opens.
3. Select **Date & Time > Time zone**.
4. Set the correct **Region**. The time will display correctly.



## Connecting to Wi-Fi or Ethernet

Connect an Ethernet cable to the device or activate Wi-Fi and setup a connection to your Wi-Fi. If multiple network connections are used, Ethernet will be prioritized over any others.

If you are using 802.1X authentication, do [Installing an 802.1X Certificate](#) on page [18](#), before you connect to the internet.

### Connecting Ethernet

Ethernet connections must be plugged into the back of the device, see ⑧ in [Defining KT-2010-GEN2 10" Touch Panel](#) on page [7](#). By default, the IP address of the device is set automatically by a DHCP server.

#### Enabling 802.1X authentication

1. Do [Installing an 802.1X Certificate](#) on page [18](#).
2. In the **Settings** screen , select **Network & Internet > Ethernet**.
3. Make sure the **Ethernet** is disabled and then enable **Security**.



802.1X authentication cannot be applied to active Ethernet connections

4. Select **802.1X settings** and input the **EAP** (Extensible Authentication Protocol) information.

#### Using a static IP address

1. If necessary, swipe up from the bottom of the screen to bring up the PIN entry pop-up and enter the PIN (default 9428).
2. From the Home page, open the **Settings** screen .
3. In the Settings screen, select **Network & Internet > Ethernet**.
4. Press **Ethernet IP mode** and select **Static**.
5. Enter the IP information and press **Connect**.

The static IP address is setup.

### Connecting Wi-Fi

#### Enabling 802.1X authentication

1. Do [Installing an 802.1X Certificate](#) on page [18](#).
2. From the Home page, open the **Settings** screen .
3. In the Settings screen, select **Network & Internet > Wi-Fi**.
4. Make sure **Use Wi-Fi** is enabled. The device will scan and list the Wi-Fi networks.
5. Select a Wi-Fi SSID, check **Advanced options** and enter the Wi-Fi information in the fields that appear, then press **Connect**.
6. If you are using 802.1X authentication, then add the certificate information.

802.1X is enabled.

## Installing an 802.1X Certificate

802.1X certificates enhance the security of network authentication. **KT-2010-GEN2** support .pem, .pfx and .p12 certificate formats.

Installing a certificate is a two-stage process: First import the certificate and then set it up.

### Importing an 802.1X certificate

1. Copy the certificate file to an empty USB flash drive.
2. If necessary, swipe up from the bottom of the screen to bring up the PIN entry pop-up and enter the PIN (default 9428).
3. From the Home page, open the **Settings** screen .
4. Select **Advanced settings > Security > Encryption & credentials**.

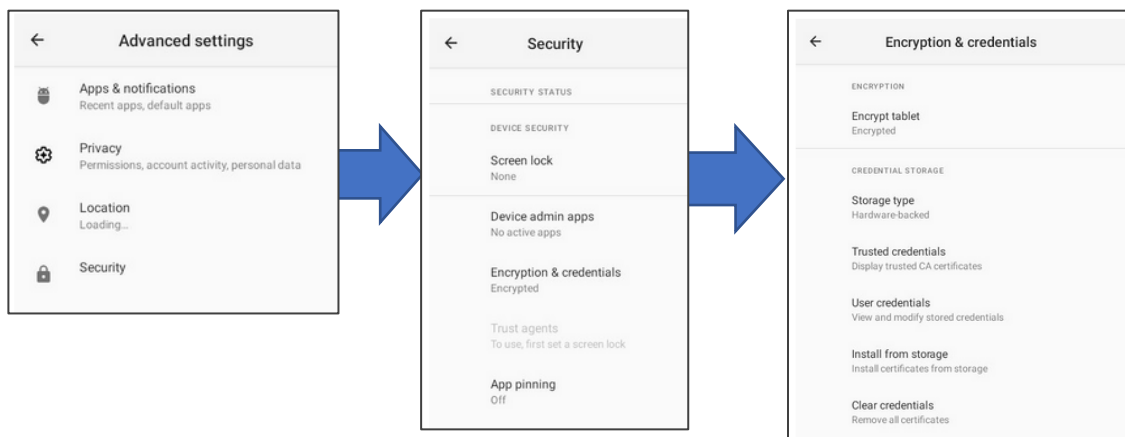



Figure 6: The path to Install from storage

5. In the Encryption & credentials screen, select **Install from storage**: The **Install a certificate** screen opens.
6. Select the **Wi-Fi certificate**: The **Recent** files screen opens. To browse to the file location, press the 3 lines  at the top left of the screen.
7. Select the credentials file and install it, some certificates require you to know a password.

### Setting up an 802.1X certificate

8. In the Settings screen, select **Network & Internet > Wi-Fi**.
9. Select **Install from storage**: The **Install a certificate** screen opens.
10. Select **Wi-Fi certificate** (also for Ethernet connections): The **Recent** files screen opens. To browse to the file location, press the 3 lines  at the top left of the screen.

After installing the certificates, see [Connecting to Wi-Fi or Ethernet](#) on page [17](#) for instructions on using the certificates. Ethernet must be disabled before setting-up Ethernet certificates.

## Changing the Automated Firmware Update

KT-2010-Gen2 arrive preset to check for firmware (touch panel OS) updates at midnight every day. If an update is found, the device will download the update file and install it. If you prefer to run manual updates, you must manually download the update file and then install it in the touch panel.

### Changing the time of the automated firmware check

1. If necessary, swipe up from the bottom of the screen to bring up the PIN entry pop-up and enter the PIN (default 9428).
2. From the Home page, open the **Settings** screen .
3. Select **Firmware update** and then select **Remote firmware upgrade URL**.

**Remote firmware upgrade URL** is the site from which the firmware is downloaded.

The upgrade URL (case sensitive):

<https://cdn.kramerav.com/web/apk/transformer-Kramer-AndroidR.xml>

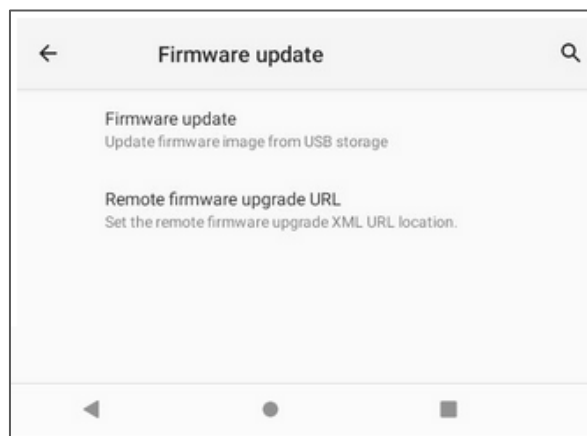

Figure 7: The Firmware update page

4. A pop-up opens, inviting you to set the check time:

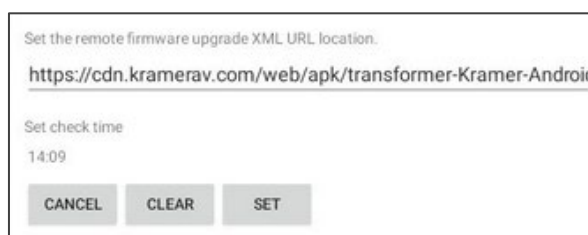

Figure 8: The Remote firmware upgrade URL page

5. To change the time that the system checks for updates, press **Set check time** and select a new time.
6. Press **OK** to close the window and then press **SET**.



**Changing (or clearing) the URL will disable the updates.**

## Manually updating the firmware

Manual firmware updates require a downloaded firmware file from Kramer.

The firmware upgrade process requires:

- An empty USB flash drive to store the firmware file.



Kramer recommends FAT32, since the firmware update is less than 4GB.

- A USB-A connector to connect the USB flash drive to the touch panel.
- Access to the back of the touch panel.  
You may need to remove the touch panel from its mount for this purpose. The touch panel should remain connected to a power source such as PoE or the optional power adapter (see ⑧ in [Defining KT-2010-Gen2 10" Touch Panel](#) on page 7).

### To upgrade the firmware

1. Download the firmware update file from the Kramer website at [https://www.kramerav.com/product/KT-2010#Tab\\_Resources](https://www.kramerav.com/product/KT-2010#Tab_Resources).
  - Verify that you are using the correct **KT-2010-Gen2** firmware file as there maybe more than one firmware file available.
  - Do not unzip the firmware update file.
2. Copy the firmware file to an empty USB flash drive.
3. If necessary, swipe up from the bottom of the screen to bring up the PIN entry pop-up and enter the PIN (default 9428).
4. On the touch panel, open the **Settings** screen .
5. Select **Firmware update** and then select **Firmware update** (again).
6. Plug the USB flash drive into a micro-USB OTG cable and connect the cable to the back of the touch panel.
7. Click **START FIRMWARE UPDATE**.

The firmware update will then begin.

## Changing the Automated Kramer Control agent update

KT-2010-GEN2 arrive preset to check for Kramer APK (Android Application Package) updates at midnight every day. If an update is found, the device will download the update file and install it.

### Changing the time of the automated APK update check

1. If necessary, swipe up from the bottom of the screen to bring up the PIN entry pop-up and enter the PIN (default 9428).
2. From the Home page, open the **Settings** screen .
3. Select **Remote APP upgrade URL**.

**Remote APP upgrade URL** is the site from which the APK is downloaded.

The upgrade URL (case sensitive) is:

[https://cdn.kramerav.com/web/apk/remote\\_app\\_update.xml](https://cdn.kramerav.com/web/apk/remote_app_update.xml)

4. A pop-up opens, inviting you to set the check time:



Set the remote APP upgrade XML URL location.  
https://cdn.kramerav.com/web/apk/remote\_app\_update.xml

Set check time  
14:00

CANCEL CLEAR SET

Figure 9: The Remote APP upgrade URL page

5. Press **Set check time** to select a new time.
6. Press **OK** to close the window and then press **SET**.



**Changing (or clearing) the URL will disable the updates.**

---

## Setting the Display and Keyboard Language

To set your preferred interface language:

1. If necessary, swipe up from the bottom of the screen to bring up the PIN entry pop-up and enter the PIN (default 9428).
2. From the Home page, open the **Settings** screen .
3. Select **Language & input**.
4. Press **Add a language** to select a language.
5. If you are using multiple languages, the order in which they are listed represents the priority assigned to them, change the order by dragging languages.
6. Press **On-screen keyboard** to select keyboard languages.

The keyboard language has been set.

---

## **For more information about using the K-agent App please refer to the K-agent User-guide**

K-Agent, Kramer's next-generation touch panel management software for Kramer Control & Session Manger providing enhanced remote administration capabilities for KT-20x Series Touch Panels.

For the full User-guide, click [here](#).

# Advanced Settings

---

## Scheduling a Daily Reboot

A daily reboot is recommended to improve product performance and stability. The daily reboot option causes the device to reset itself every day and the set time (or within 30 minutes of the set time if it is in use).

1. If necessary, swipe up from the bottom of the screen to bring up the PIN entry pop-up and enter the PIN (default 9428).
2. From the Home page, open the **Settings** screen .
3. Select **Schedule Reboot** and set the reboot time.
4. Enable **Optimize Server Performance** to have the device reboot at a random time within 30 minutes of the scheduled time. If you are using multiple devices, then this prevents them from all rebooting at the same time.

The daily reboot is complete.

---

## Password Protecting Device Settings

Device settings can be protected with a password to prevent users from making any changes.

1. If necessary, swipe up from the bottom of the screen to bring up the PIN entry pop-up and enter the PIN (default 9428).
2. From the Home page, open the **Settings** screen .
3. Select **Security Password** to enable and enter the password.



---

## Factory Reset & Reboot

The **Settings > Reset** options menu enables you to perform a factory reset or to reboot the device, reset Wi-Fi or Bluetooth or reset app preferences.

### To reset to factory settings

1. If necessary, swipe up from the bottom of the screen to bring up the PIN entry pop-up and enter the PIN (default 9428).
2. From the Home page, open the **Settings** screen .
3. Select **Erase all data (factory reset)**.

Other options available: Reboot device, Reset Wi-Fi, mobile & Bluetooth and Reset app preferences.

### Resetting with the external reset button

Insert a pin into the pinhole on the back  (see [Defining KT-2010-Gen2 10" Touch Panel](#) on page [7](#)) and hold for 22 seconds to reset the device to factory default values.

A second pinhole on the top,  can be used to restart the device by inserting a pin for a few seconds.

---

## Logging Activity

By default, the device does not log activity. Logging can be useful for debugging or monitoring use.

### Activating logging

1. From the Home page, open the **Settings** screen .
2. Select **Log** and set the **Log Location**.

Logging is activated.

### Accessing an internally stored log file

A USB flash drive and OTG cable are required to copy an internally stored log file:

1. In the root directory of the flash drive, create a folder called “**\_dump\_debug\_log**”.
2. Connect the OTG cable to the micro-USB connection on the back of the device.
3. Connect the flash drive to the OTG cable.
4. The device will automatically download the log file to the USB device and issue a confirmation message “**Saved log file to USB storage**”.

The log is accessed.

## Defining an auto-start playlist

The device can be set to automatically play the contents of a predefined folder. The folder can be internally defined or read from a flash device connected to the micro USB port or a Micro SD card inserted into the card reader (see [Defining KT-2010-Gen2 10" Touch Panel](#) on page 7).

To setup a playlist:

1. Load the media you want to play onto an SD card or USB flash drive. Play order is set by the alphabetic order of the item's names.
2. Connect the drive or card to the device (for a flash drive use an OTG cable connected to the USB port).
3. If necessary, swipe up from the bottom of the screen to bring up the PIN entry pop-up and enter the PIN (default 9428).
4. On the touch panel, open the **Settings** screen .
5. Select Player Settings and then select Instant Play.
6. Enable **Instant play**. If you check **Copy and play as internal storage**, the device will load the (external) folder contents into internal storage.
7. Press SELECT FOLDER.
8. If you copied external content to internal storage, then you can remove the external device.

The Content field in the Home page will be changed to the storage location of your content.



The home page's Content field defines the auto-start link to Kramer Control.

Changing the value in this field is not recommended as it will disable Kramer Control.

## Defining auto-start HTML or SMIL content

The device home page can be set to automatically run an HTML page or SMIL content.

1. Place your HTML content in a folder called HTML in the root of an SD card or flash drive and attach them to the device (for a flash drive use an OTG cable connected to the USB port).
2. When the USB drive is connected to the device, an automatic pop-up message will notify you that the copy is about to start.

The Content field in the Home page will be changed to the storage location of your content.



The home page's Content field defines the auto-start link to Kramer Control.

Changing the value in this field is not recommended as it will disable Kramer Control.

## Modifying Display Settings

The screen orientation can be customized, and the navigation bar can be hidden.

### Changing the screen orientation

1. If necessary, swipe up from the bottom of the screen to bring up the PIN entry pop-up and enter the PIN (default 9428).
2. From the Home page, open the **Settings** screen .
3. Select Display and then press Screen Orientation.

Choose between 0 degrees (default), 90 degrees, 180 degrees and 270 degrees.

### Hiding the navigation bar

1. If necessary, swipe up from the bottom of the screen to bring up the PIN entry pop-up and enter the PIN (default 9428).
2. From the Home page, open the **Settings** screen .
3. In the Settings menu, open **Player settings** and enable **Fullscreen mode**.

The Navigation bar is no longer accessible.

## Switching to Native Android Mode

Switching to native Android mode turns the device into a regular android device, allowing you full control of its content.



Changing to native Android will disable Kramer Control.

To make the switch:

1. If necessary, swipe up from the bottom of the screen to bring up the PIN entry pop-up and enter the PIN (default 9428).
2. From the Home page, open the **Settings** screen .
3. Select Player Settings and then press Native Android Mode.



Figure 10: The Player settings page

Native Android mode is restored.

# Technical Specifications

Ports	1 USB Type C	On a female (OTG/ADB) connector
	1 USB Type A	On a female connector
	1 Ethernet	On an RJ-45 female connector, 10/100/1000M with PoE 802.3at
Platform	Operating System	Android Version 13
	CPU	Genio 510 Hexa Core
Memory	RAM	LPDDR4 4GB
	Internal	32GB eMMC (flash)
Display	Touch Panel Type	Capacitive multi-touch
	Size	10.1"
	Resolution	1920x1200 RGB pixels, 16:9 aspect ratio, >350cd/m2 brightness, 1000:1 contrast ratio
Wireless Connectivity	Wi-Fi	Wi-Fi 6, 802.11 a/b/g/n/ax
	Bluetooth	BT 5.2
Video	Camera	1x 13MP FF
	Video Formats	H.264, H.265, VC-1, MPEG-4, VP8, VP9
	Image Codecs	JPEG, BMP, GIF, PNG
	VESA	Metal-fittings mounting screw holes for 75x75mm VESA mount
Audio	Speakers	2 built-in x 1.5W
	Codecs	MPEG, OGG, AAC
	Microphone	2 built-in
Power	PoE	44 to 57V DC 0.6A complies with IEEE802.3af and IEEE802.3at PoE standards
	Optional power adapter	12V DC 1.5 A Note: Operating Temperature: 0~40°C
Controls	Function button	On top
	Reset button	On top, recessed
	Factory reset button	On back, recessed
LED	Side-light	Can indicate room status (requires 3 <sup>rd</sup> party integration)
Environmental conditions	Operating temperature	0~40°C (32~104°F)
	Storage temperature	-20~60°C (-4° to 140°F)
	Operating Humidity	5% to 85%
	Storage Humidity	5% to 90%
Regulatory Compliance	Safety	CE, FCC, UKCA
	Environmental	RoHs, WEEE
Dimensions	Touch panel (W, D, H)	242 x 21 x 173mm (9.5 x 0.8 x 6.8in)
	Touch panel table top stand (W, D, H)	131 x 111 x 98mm (5.1 x 4.3 x 3.8in)
	Wall mount (W, D, H)	120 x 115 x 11mm (4.7 x 4.5 x 0.4in) See the image in <a href="#">Mounting KT-2010-GEN2 on a Wall</a> on page <a href="#">11</a> .
Weight	Touch panel	482g (1lb)
	Touch panel stand	300g (0.6lb)
Shipping carton (4 pcs)	Dimensions (W, D, H)	309 x 242 x 175mm (12 x 9.5 x 6.8in)
	Weight	KT-2010-GEN2: 1.4kg (approximate) (3.08lb)
Accessories	Optional	Power adapter.
	KT-2010-Gen2	Table-top mount, On Wall mount and screws
Specifications are subject to change without notice at <a href="http://www.kramerav.com">www.kramerav.com</a>		





**HDMI™**  
HIGH-DEFINITION MULTIMEDIA INTERFACE



P/N: 2900-301867



Rev: 1



#### SAFETY WARNING

Disconnect the unit from the power supply before opening and servicing

For the latest information on our products and a list of Kramer distributors, visit our website where updates to this user manual may be found.

We welcome your questions, comments, and feedback.

The terms HDMI, HDMI High-Definition Multimedia Interface, and the HDMI Logo are trademarks or registered trademarks of HDMI Licensing Administrator, Inc. All brand names, product names, and trademarks are the property of their respective owners.