



Google TV

Digital Projector User Manual

Home Series | GP520

V 1.00

Copyright & disclaimer

Copyright

Copyright © 2024 by BenQ Corporation. All rights reserved. No part of this publication may be reproduced, transmitted, transcribed, stored in a retrieval system or translated into any language or computer language, in any form or by any means, electronic, mechanical, magnetic, optical, chemical, manual or otherwise, without the prior written permission of BenQ Corporation.

The Bluetooth® word mark and logos are registered trademarks owned by Bluetooth SIG, Inc. and any use of such marks by BenQ Corporation is under license.

iOS is a trademark or registered trademark of Cisco in the U.S. and other countries and is used under license.

macOS® is a trademark of Apple Inc., registered in the U.S. and other countries.

Google TV is the name of this device's software experience and a trademark of Google LLC. Google, YouTube, Google Cast, YouTube Music and other marks are trademarks of Google LLC.

NETFLIX

Netflix is a trademark of Netflix, Inc.



Manufactured under license from Dolby Laboratories. Dolby, Dolby Audio, and the double-D symbol are trademarks of Dolby Laboratories Licensing Corporation.



The terms HDMI, HDMI High-Definition Multimedia Interface, HDMI Trade dress and the HDMI Logos are trademarks or registered trademarks of HDMI Licensing Administrator, Inc.

All other logos, products, or company names mentioned in this manual may be the registered trademarks or copyrights of their respective companies, and are used for informational purposes only.

Disclaimer

BenQ Corporation makes no representations or warranties, either expressed or implied, with respect to the contents hereof and specifically disclaims any warranties, merchantability or fitness for any particular purpose. Further, BenQ Corporation reserves the right to revise this publication and to make changes from time to time in the contents hereof without obligation of BenQ Corporation to notify any person of such revision or changes. This user manual aims to provide the most updated and accurate information to customers, and thus all contents may be modified from time to time without prior notice. Please visit <http://support.benq.com> for the latest version of this manual.

It is the sole responsibility of the user if problems (such as data loss and system failure) occurred due to non-factory installed software, parts, and/or non-original accessories.

Warranty

BenQ warrants this product against any defects in material and workmanship, under normal usage and storage.

Proof of purchase date will be required with any warranty claim. In the event this product is found to be defective within the warranty period, BenQ's only obligation and your exclusive remedy shall be replacement of any defective parts (labor included). To obtain warranty service, immediately notify the dealer from which you purchased the product of any defects.

Important: The above warranty shall be void if the customer fails to operate the product in accordance with BenQ's written instructions, especially the ambient humidity must be in-between 10% and 90%, temperature in-between 0°C and 40°C, altitude lower than 2000 meters, and avoiding to operate the projector in a dusty environment. This warranty gives you specific legal rights, and you may have other rights which vary from country to country.

For other information, please visit www.BenQ.com.

Statement regarding hyperlinks and third-party websites

BenQ is not responsible for the content of the websites or of similar resources, which are maintained and controlled by third parties, that may be linked from this product. Providing links to those websites or to similar resources does not mean that BenQ makes any warranty or representation to their content by expression or by implication.

Any third party content or service preinstalled in this product is provided "as is". BenQ does not, by expression or by implication, make any warrant to the content or to the services provided by third parties. BenQ does not warrant or guarantee that the content or services provided by third parties are accurate, effective, most up-to-date, legal, or complete. Under no circumstances shall BenQ be liable for the content or services provided by third parties including their negligence.

Services provided by third parties may be terminated temporarily or permanently. BenQ does not warrant or guarantee that any content or services provided by third parties are in good condition at any time, and is not liable for the termination of the said content and services.

In addition, BenQ is not involved in any transactions you conduct in the websites or similar resources maintained by third parties.

You should contact the content or service providers for any questions, concerns, or disputes.

BenQ ecoFACTS

BenQ has been dedicated to the design and development of greener product as part of its aspiration to realize the ideal of the "Bringing Enjoyment 'N Quality to Life" corporate vision with the ultimate goal to achieve a low-carbon society. Besides meeting international regulatory requirement and standards pertaining to environmental management, BenQ has spared no efforts in pushing our initiatives further to incorporate life cycle design in the aspects of material selection, manufacturing, packaging, transportation, using and disposal of the products. BenQ ecoFACTS label lists key eco-friendly design highlights of each product, hoping to ensure that consumers make informed green choices at purchase.

Check out BenQ's CSR Website at <http://csr.BenQ.com/> for more details on BenQ's environmental commitments and achievements.

Product carbon footprint (PCF)

The carbon footprint of a product is the estimated carbon emission throughout its entire life cycle. The information may be available on the package or [online](#).

The carbon footprint stated for this product is the current estimate and the actual result may be subject to change due to unforeseen conditions. This means the actual product carbon footprint may be different from the declared statement.

You may not find your product's carbon footprint as it was not available at the time the product was shipped. The information should be online once it's available.



Product support

You are strongly recommended to upgrade the product to the latest firmware version and refer to the most up-to-date user manual to make best use of the product.

This document aims to provide the most updated and accurate information to customers, and thus all contents may be modified from time to time without prior notice. Please visit the website for the latest version of this document and other product information. Available files vary by model.

1. Make sure your computer is connected to the Internet.
2. Visit the local website from Support.BenQ.com. The website layout and content may vary by region/country. Look for the following regularly to get the most up-to-date information.
 - User manual and related document
 - Firmware and application
 - Frequently asked questions

Servicing

- If misuse or other accident occurs, contact qualified service personnel for servicing.
- Contact your place of purchase or visit the local website from [Support.BenQ.com](https://support.benq.com) for more support.



[Support.BenQ.com](https://support.benq.com)

Q&A index

Start with the topics you are interested in:

Setup

How do I set up the projector and turn it on?	
Choosing a location	27
Powering on and initial setup	32

Image adjustment

How do I adjust the focus of the projected image?	
Fine-tuning the image clarity	41
How do I fit the projected image to the screen?	
Keystone	42
Screen Fit	43

Usage

How do I project wirelessly?	
Wireless projection (screen casting)	53
How do I play music via the projector?	
Playing music with your projector	57

Maintenance and product support

What should I do if I don't plan to use the projector for a long time?	
Storing the projector	68

Table of Contents

Copyright & disclaimer	2
Copyright	2
Disclaimer	3
Warranty.....	3
Statement regarding hyperlinks and third-party websites	4
BenQ ecoFACTS	4
Product carbon footprint (PCF).....	5
Product support	5
Servicing	6
Q&A index	7
Safety instructions	12
Package contents	17
Introduction	18
Projector overview	18
Overview	18
Keypad	20
I/O ports.....	21
Dimensions.....	22
Projector connections	23
Wireless connection	23
Wired connection (USB-A port)	23
Wired connection (HDMI port)	23
Wired connection (USB-C port)	23
Remote control	25
Remote control effective range.....	26
Installation	27
Choosing a location	27
Obtaining a preferred image size	29
Projection dimensions	29

Using the projector in an outdoor setting.....	30
Using the projector at high altitude	30
Getting started.....	32
Powering on and initial setup.....	32
Power LED indicator.....	33
Power settings and options for saving power	35
Shutting down the projector	36
Accessing helpful BenQ apps.....	37
Apps downloaded to your projector	37
Download SmartRemoote for BenQ Projector app to your mobile device.....	37
Upgrading your projector.....	38
Updating the operating system.....	38
Advanced firmware updating	38
Mounting.....	39
Tripod mounting (purchased separately).....	39
Screw location.....	39
Flexible setup	39
Working with a tripod plate.....	40
Ceiling mounting.....	42
Screw location.....	42
Adjusting the projected image.....	43
Fine-tuning the image clarity	43
Fitting the image to your screen.....	44
Keystone	44
Screen Fit.....	45
Obstacle avoidance	46
Projection size and position adjustment (Digital zoom and image reposition)	46
Image rotation	47
Adjusting screen brightness.....	47

Activating smart eye protection.....	47
Optimizing image quality by Auto Cinema mode.....	47
Changing the input source	48
Watching streaming videos.....	49
Google TV home screen	49
Dashboard.....	50
Choosing a proper picture mode for video streaming.....	51
Choosing a proper sound mode for video streaming.....	52
Enhancing gaming experience	54
Auto Low Latency Mode (ALLM).....	54
Game mode boost.....	54
Projection.....	55
Wireless projection (screen casting)	55
Screen casting from iOS/macOS device devices	55
Screen casting from Android™ OS devices with Google Cast™	56
Screen casting from Android™ OS devices with Google Home	56
Screen casting from PC devices with Google Cast™	57
Wired projection.....	58
Playing music with your projector	59
Making your projector a Bluetooth speaker	59
Using the Bluetooth speaker mode button.....	60
Connecting the projector to an external Bluetooth speaker / headphone.....	61
Making your projector a wireless speaker.....	61
Turning the screen off during music playback.....	62
Playing multimedia files from a USB flash drive.....	63
Power delivery to a USB-C device	64
USB-C power delivery notice.....	64
Menu navigation	65
Set your device name.....	65

Projector	65
Display & Sound	67
Network & Internet	68
Accounts & sign-in	69
Privacy	69
Apps	69
System.....	69
Remotes & Accessories	69
Maintenance	70
Care of the projector	70
Cleaning the lens.....	70
Storing the projector	70
Transporting the projector	71
Light source information	71
Troubleshooting	72
Specifications	75
Projector specifications	75
Timing chart.....	77
HDMI input.....	77
USB-C input.....	80
Supported file formats	82
Video	82
Audio.....	83

Safety instructions

Your projector is designed and tested to meet the latest standards for safety of information technology equipment. However, to ensure safe use of this product, it is important that you follow the instructions mentioned in this manual and marked on the product.

1. Please read this user manual before you operate your projector.
Keep this manual in a safe place for future reference.

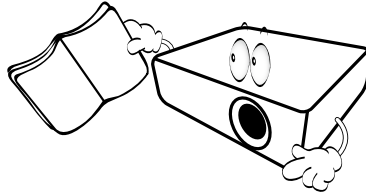

2. Always place the projector on a level, horizontal surface during operation.
 - Do not place the projector on an unstable cart, stand, or table as it may fall and be damaged.
 - Do not place inflammables near the projector.
Do not use if tilted at an angle of more than 10 degrees left to right, nor at angle of more than 15 degrees front to back.

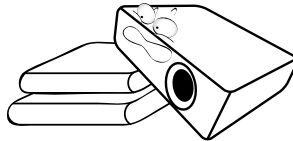

3. Do not store the projector on end vertically. Doing so may cause the projector to fall over, causing injury or resulting in damage.

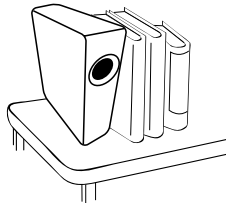

4. Do not place this projector in any of the following environments.
 - Space that is poorly ventilated or confined. Allow at least 50 cm clearance from walls and free flow of air around the projector.
 - Locations where temperatures may become excessively high, such as the inside of a car with all windows rolled up.
 - Locations where excessive humidity, dust, or cigarette smoke may

contaminate optical components, shorten the projector's lifespan and darken the screen.

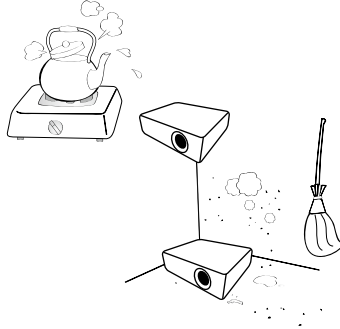

- Locations near fire alarms.
- Locations with an ambient temperature above 40°C /104°F
- Locations where the altitudes are higher than 2000 m (6562 feet).

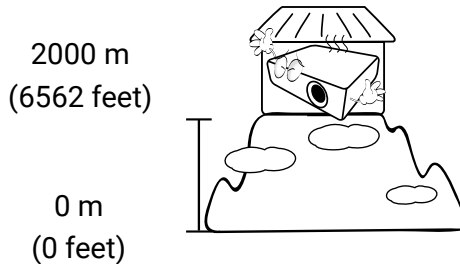

5. Do not block the vents holes while the projector is on (even in power-saving mode).
 - Do not cover the projector with any item.
 - Do not place the projector on a blanket, bedding or any other soft surface.

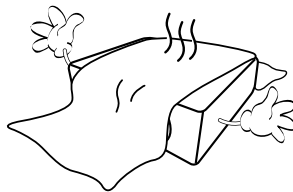

6. In areas where the mains power supply voltage may fluctuate by ± 10 volts, it is recommended that you connect the projector through a power stabilizer, surge protector or uninterruptible power supply (UPS) as appropriate to your situation.

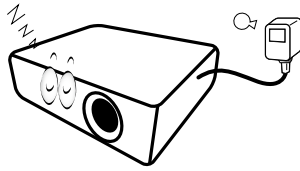

7. Do not step on the projector or place any objects upon it.

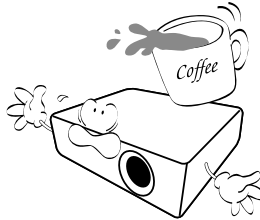

8. Do not place liquids near or on the projector. Liquids spilled into the projector will void your warranty. If the projector does become wet, disconnect it from the power point and call BenQ to have the projector repaired.

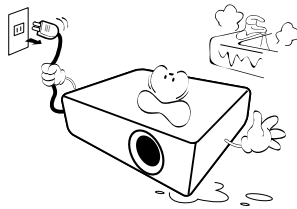

9. Do not look straight into the projector lens during operation. It may harm your sight.

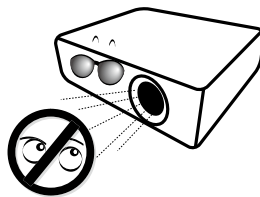

10. Do not operate the projector laser beyond the rated laser life.

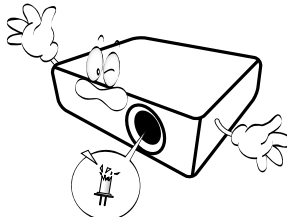

11. Do not attempt to disassemble this projector. There are dangerous high voltages inside which may cause death if you should come into

contact with live parts.

Under no circumstances should you ever undo or remove any other covers. Refer servicing only to suitably qualified professional service personnel.

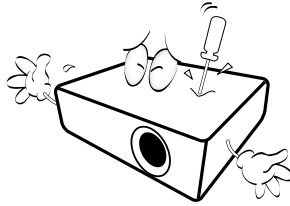

Warning

- Please keep the original packing for possible future shipment.
- If you need to pack your projector after use, adjust the projection lens to an appropriate position, put the lens cushion around the lens, and fit the lens cushion and projector cushion together to prevent damage during transportation.

12. When you think service or repair is required, take the projector only to a suitably qualified technician.

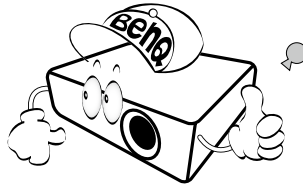

Moisture condensation

Never operate the projector immediately after moving it from a cold location to a hot location. When the projector is exposed to such a change in temperature, moisture may condense on the crucial internal parts. To prevent the projector from possible damage, do not use the projector for at least 2 hours when there is a sudden change in temperature.

Avoid volatile liquids

Do not use volatile liquids, such as insecticide or certain types of cleaner, near the projector. Do not have rubber or plastic products touching the projector for a long time. They will leave marks on the finish. If cleaning with a chemically treated cloth, be sure to follow the cleaning product's safety instructions.

Disposal

This product contains the following materials which are harmful to human bodies and environment.

- Lead, which is contained in solder.

To dispose of the product, consult your local environment authorities for regulations.

Note

- The illustrations and the images shown in this document are for your reference.
- The actual content may vary by the product supplied for your region.

Package contents

Carefully unpack and verify that you have all of the items shown below. Some of the items may not be available depending on your region of purchase. If any of these items are missing, please contact your place of purchase.

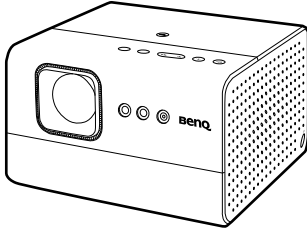

Projector

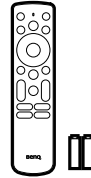

Remote control
(With two AAA batteries)



Power adapter



Power cord
(Varies by region)



User documents

Note

- Actual product's features and specifications are subject to change without notice.
- Some of the accessories may vary by region.
- The warranty card is only supplied in some specific regions. Please consult your dealer for detailed information, or check warranty information online.
- Use original accessories to ensure compatibility.
- Power cord plug type may change based on regional requirements.

Introduction

Projector overview

Overview

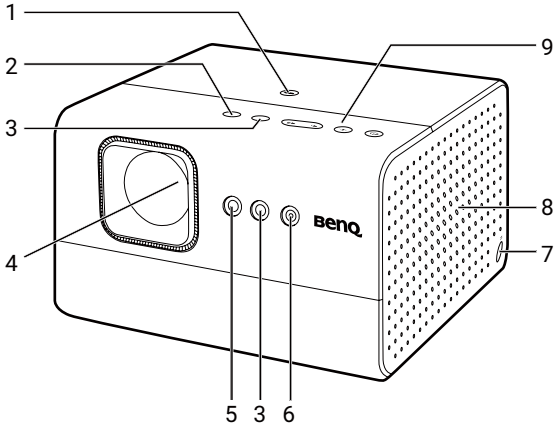

No.	Descriptions
1.	Tripod screw hole See " Tripod mounting (purchased separately) " on page 39 for details.
2.	Ambient Light Sensor (ALS)
3.	IR remote control sensor
4.	Projection lens
5.	Time of Flight (ToF) sensor
6.	Auto focus camera
7.	Power adapter port
8.	Right speaker and vents
9.	Keypad See " Keypad " on page 20 for details.

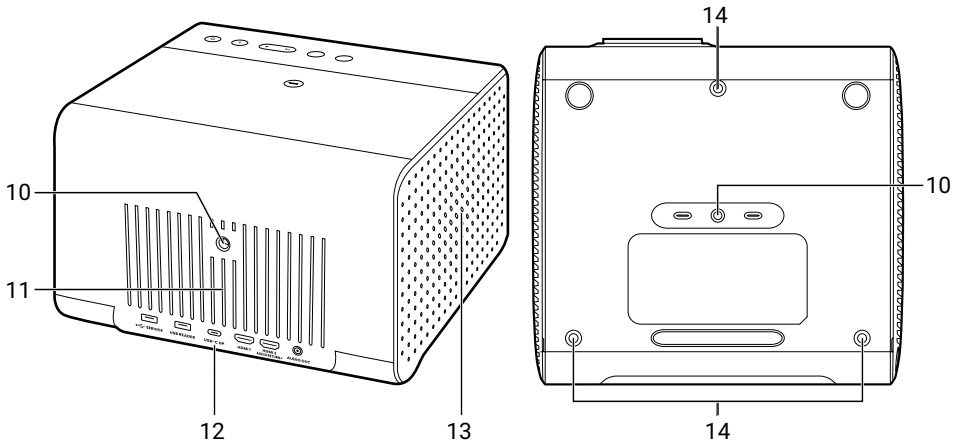

No.	Descriptions
10.	Tripod screw hole See " Tripod mounting (purchased separately) " on page 39 for details.
11.	Air vents
12.	I/O ports <ul style="list-style-type: none"> • See "I/O ports" on page 21 for details. • See "Projector connections" on page 23 for details.
13.	Left speaker and vents
14.	Ceiling mount screw holes See " Ceiling mounting " on page 42 for details.

Keypad

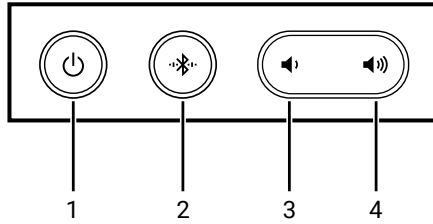

No.	Descriptions
1.	Power button and LED See "Power LED indicator" on page 33 for details.
2.	Bluetooth speaker mode button and LED See "Using the Bluetooth speaker mode button" on page 60 for details.
3.	Volume down button
4.	Volume up button

I/O ports

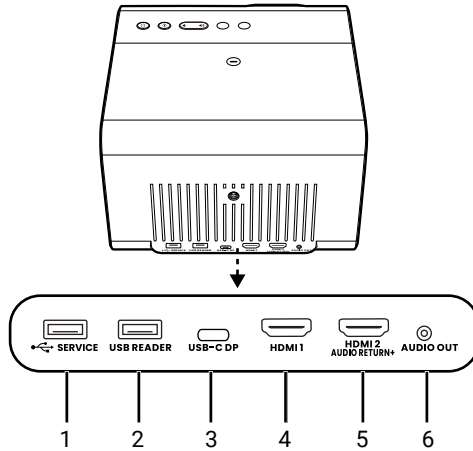

No.	Descriptions
1.	USB Type-A port (for service) See "Advanced firmware updating" on page 38 for details.
2.	USB Type-A port (for media reader) See "Playing multimedia files from a USB flash drive" on page 63 for details.
3.	USB Type-C port See the following for details. <ul style="list-style-type: none">• "Wired projection" on page 58• "Playing multimedia files from a USB flash drive" on page 63• "Power delivery to a USB-C device" on page 64
4.	HDMI 1 input port See "Wired projection" on page 58 for details.
5.	HDMI 2 input port (with Audio Return Channel+) See "Wired projection" on page 58 for details.
6.	3.5mm audio output jack

Dimensions

241.3 (W) x 225.0 (D) x 151.0 (H) mm (9.49 x 8.86 x 5.94 in)

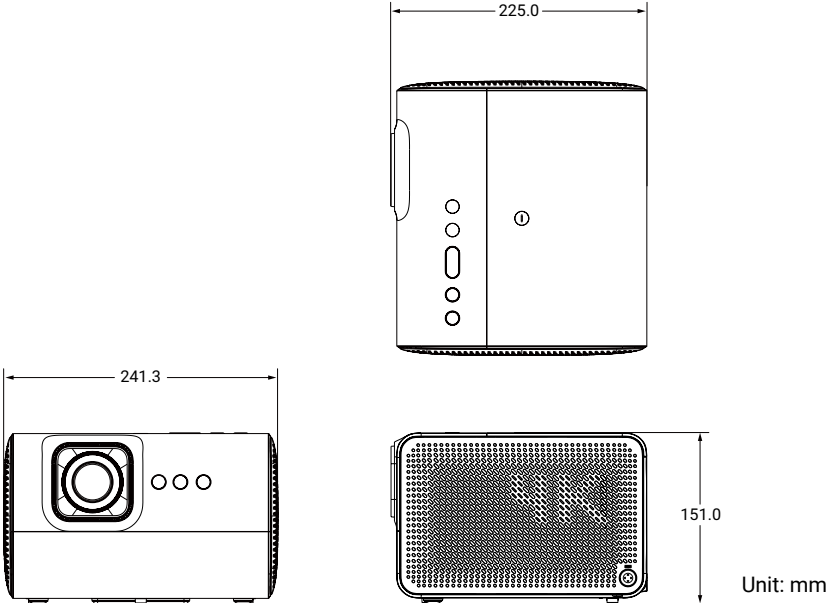

Unit: mm

Projector connections

You can connect your device to the projector in various ways to project video content.

Wireless connection

- Smartphone, tablet, laptop/PC (see ["Wireless projection \(screen casting\)" on page 55](#))
- Bluetooth devices (speakers, headphone, mouse, etc.)

Before making any wireless connections, be sure to place the projector within range of the wireless AP you plan to connect it to.

Wired connection (USB-A port)

- USB-A flash drive (see ["Playing multimedia files from a USB flash drive" on page 63](#))

Wired connection (HDMI port)

- A/V device
- Smartphone, tablet, laptop/PC

Wired connection (USB-C port)

- Smartphone, tablet, laptop/PC (see ["Wired projection" on page 58](#))
- USB-C flash drive (see ["Playing multimedia files from a USB flash drive" on page 63](#))

Before making any wired connections, be sure to use the correct cable with corresponding functions (e.g., DP Alt Mode or Power Delivery) for each source and that it is plugged in securely. Connection with USB-C cables/devices certified by USB-IF may increase compatibility.

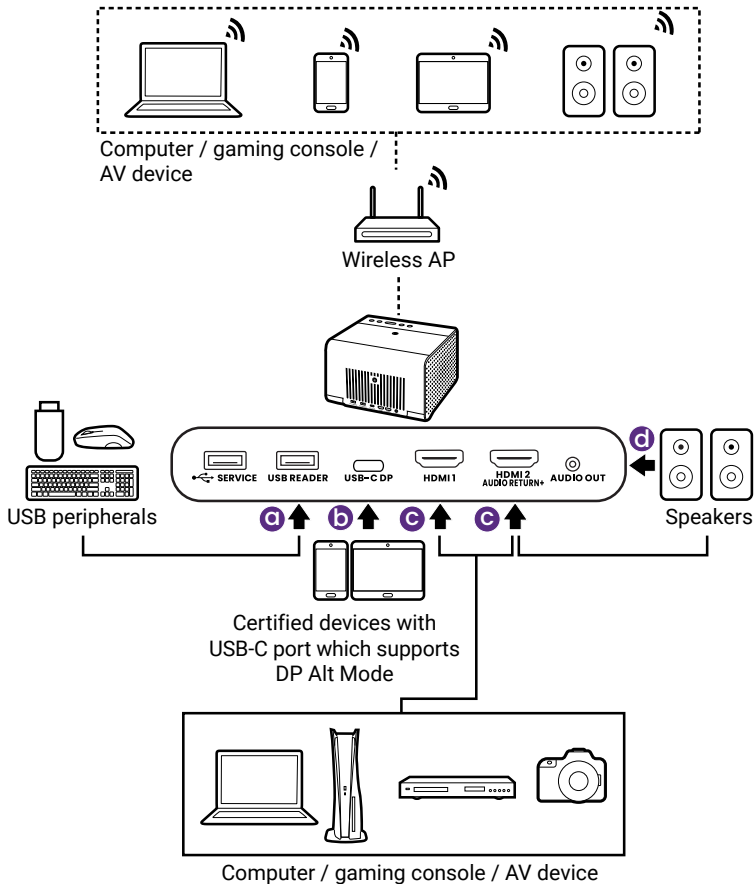

No.	Descriptions	No.	Descriptions
a.	USB flash drive for media reader and peripherals	c.	HDMI cable
b.	Certified DP Alt mode USB-C cable	d.	Audio cable

Note

- In the connections above, some cables may not be included with the projector (see "[Package contents](#)" on page 17). They are commercially available from stores.
- The connection illustrations are for reference only.
- If the selected video image is not displayed after the projector is turned on and the correct video source has been selected, check that the video source device is turned on and operating correctly. Also check that the signal cables have been connected correctly.
- The built-in speaker(s) will be muted when the AUDIO OUT jack is connected.

Remote control

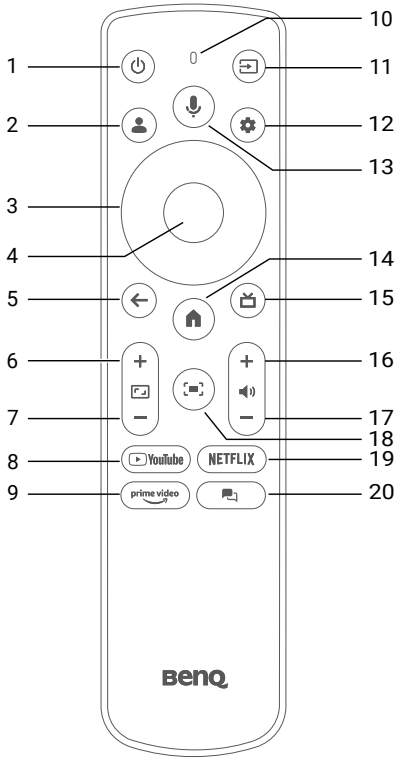

No.	Descriptions
1.	Power
2.	Profiles
3.	Arrow keys
4.	OK
5.	Back
6.	Digital zoom in
7.	Digital zoom out
8.	YouTube
9.	Prime Video

No.	Descriptions
10.	Microphone
11.	Source
12.	Dashboard
13.	Voice search
14.	TV home screen
15.	HDMI source
16.	Volume up
17.	Volume down
18.	<ul style="list-style-type: none"> Screen adjustment Auto Cinema mode (See page 47) <p>Note</p> <p>When Picture Mode is set to Auto Cinema, pressing this button will activate both the screen adjustment function and the Auto Cinema mode setting. When Picture Mode is not set to Auto Cinema, pressing this button will activate only the screen adjustment function.</p>
19.	NETFLIX Netflix
20.	<ul style="list-style-type: none"> Projector Assistant Audio-only mode (See page 62)

Tip

You are provided with the **SmartRemote for BenQ Projector** app as an alternative of remote control. Install the app on your mobile device and make it your new remote control. Check ["Accessing helpful BenQ apps" on page 37](#) for more information.

Remote control effective range

The projector has one IR remote control sensor located at the front of the projector and another sensor at its top side with a range of 8 meters (~26 feet) at an angle of 30 degrees (left and right) and 20 degrees (up and down). Prior to remote control pairing process during the setup wizard (see "[Powering on and initial setup](#)" on page 32), the remote control can only be used either by pointing it directly at the IR sensor or by reflecting the IR signal off of a wall/screen, making sure that there are no obstacles between the remote control and the IR sensors on the projector.

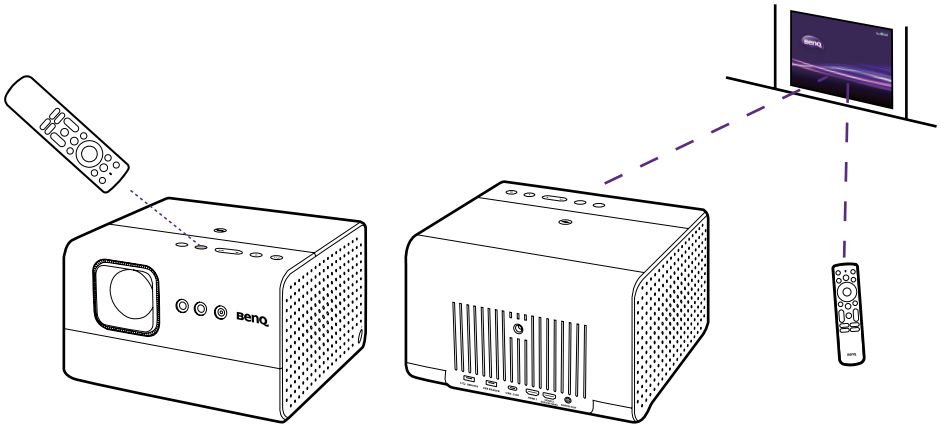

Once the remote control has been paired to the projector, you will be able to use it at any angle within a range of 8 meters (~26 feet).

Note

Voice search functionality on the remote control is only available after the remote control has been paired to the projector. See "[Powering on and initial setup](#)" on page 32 for more details.

Installation

Choosing a location

Before choosing an installation location for your projector, take the following factors into consideration:

- Size and position of your screen
- Electrical outlet location
- Location and distance between the projector and the rest of your equipment
- Location and distance between the projector and the wireless access point

You can install your projector in the following ways from **⚙️ > All settings > Projector > Advanced Settings > Projection Mode.**

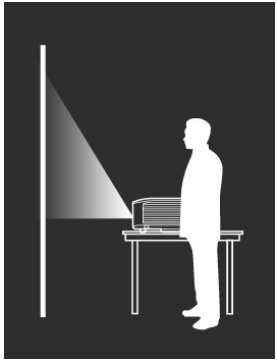
<ul style="list-style-type: none">• Auto Changes the projection mode automatically by detecting whether the projector is placed upside down between Front and Front Ceiling by the using scenario (upward or downward). The audio channels are switched accordingly to go with the projector position.	
<ul style="list-style-type: none">• Front Select this location with the projector placed near the floor in front of the screen. This is the most common way to position the projector for quick setup and portability.	

- **Front Ceiling**

Select this location with the projector elevated near the ceiling in front of the screen.

The audio channels are switched accordingly to go with the projector position.

Note

The projector does not feature ceiling mount components/equipment. When choosing to use a ceiling location, you must place it on an elevated and even shelf purchased separately. Make sure the shelf is stable enough to support the projector's weight. Secure the shelf properly and keep the projector from falling.

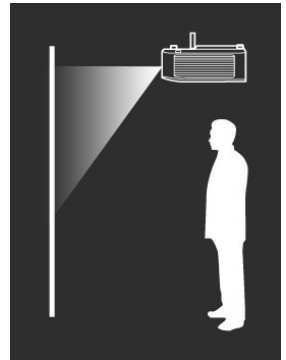

- **Rear**

Select this location with the projector placed near the floor behind the screen.

The audio channels are switched accordingly to go with the projector position.

Note

A special rear projection screen is required.

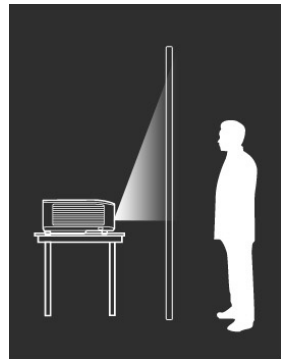

- **Rear Ceiling**

Select this location with the projector elevated from the ceiling behind the screen.

Note

- A special rear projection screen is required.
- The projector does not feature ceiling mount components/equipment. When choosing to use a ceiling location, you must place it on an elevated and even shelf purchased separately. Make sure the shelf is stable enough to support the projector's weight. Secure the shelf properly and keep the projector from falling.

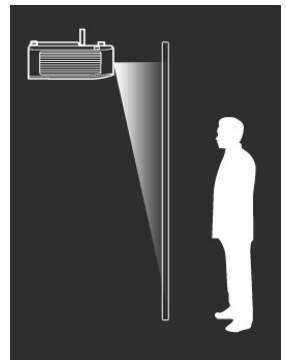

Obtaining a preferred image size

The distance from the projector lens to the screen, the zoom setting, and the video format each factors in the projected image size.

Projection dimensions

The screen aspect ratio is 16:9 and the projected picture is in a 16:9 aspect ratio.

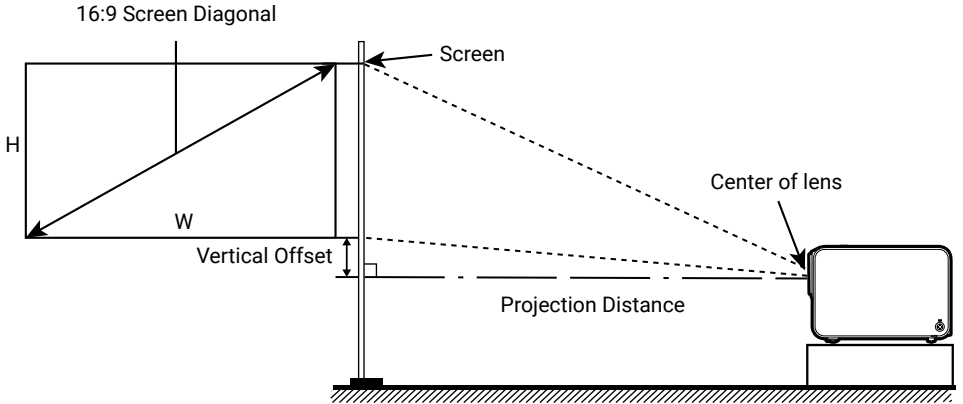

Screen size		W (mm)	H (mm)	Projection Distance (mm)
Inch	mm			
50	1270	1107	623	1328
60	1524	1328	747	1594
70	1778	1550	872	1860
80	2032	1771	996	2125
90	2286	1992	1121	2391
100	2540	2214	1245	2657
110	2794	2435	1370	2922
120	3048	2657	1494	3188
130	3302	2878	1619	3454
140	3556	3099	1743	3719
150	3810	3321	1868	3985
160	4064	3542	1992	4250

Screen size		W (mm)	H (mm)	Projection Distance (mm)
Inch	mm			
170	4318	3763	2117	4516
180	4572	3985	2241	4782

For example, if you are using a 100-inch screen, the recommended projection distance is 2,657 mm.

If your measured projection distance is 2,391 mm, the projected screen size is 90-inch.

Note

- All measurements are approximate and may vary from the actual sizes.
- BenQ recommends that if you intend to permanently install the projector, you should physically test the projection size and distance using the actual projector in situ before you permanently install it, so as to make allowance for this projector's optical characteristics. This will help you determine the exact mounting position so that it best suits your installation location.

Using the projector in an outdoor setting

The projector is designed mainly for indoor use but its portable design also allows it to support occasional outdoor use. When using the projector outdoors, install the projector on a tripod if there is no flat surface to place the projector. See "[Tripod mounting \(purchased separately\)](#)" on page 39 for more details.

Set a preferred picture mode for the most suitable setting. See "[Choosing a proper picture mode for video streaming](#)" on page 51 for more details.

Using the projector at high altitude

We recommend you use the **High Altitude Mode** when your environment is between 1500 m - 2000 m above sea level and the ambient temperature is between 0°C to 30°C.

Operation under the **High Altitude Mode** may cause a higher decibel of operating noise level because of the increased fan speed necessary to improve overall system cooling and performance.

If you use this projector under other extreme conditions excluding the above, it may display auto shut-down symptoms, which is designed to protect your projector from over-heating.

In cases like this, you should switch to **High Altitude Mode** to solve these symptoms. Go to  > **All settings** > **Projector** > **Advanced Settings** > **More** > **High Altitude Mode**.

However, this is not to state that this projector can operate under any and all harsh or extreme conditions.

Getting started

Powering on and initial setup

1. Choose a preferred location and image size as instructed in "[Choosing a location](#)" on page 27.
2. Install the remote control's batteries.

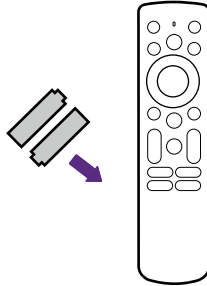



Note

Avoid leaving the remote control and batteries in an excessively hot or humid environment like the kitchen, bathroom, sauna, sunroom or in a closed car.

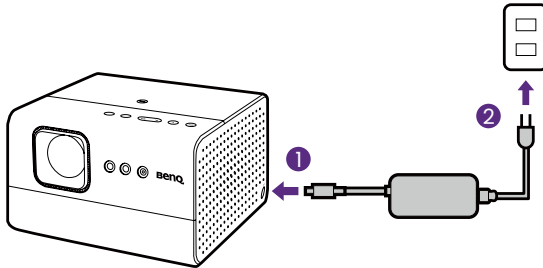
3. Connect power to the projector.



4. Press and hold the power button  on the projector for 1 second or press the power button  on the remote control. The power LED will flash green when the projector is powering and then turn solid green when the projector is ready for use.

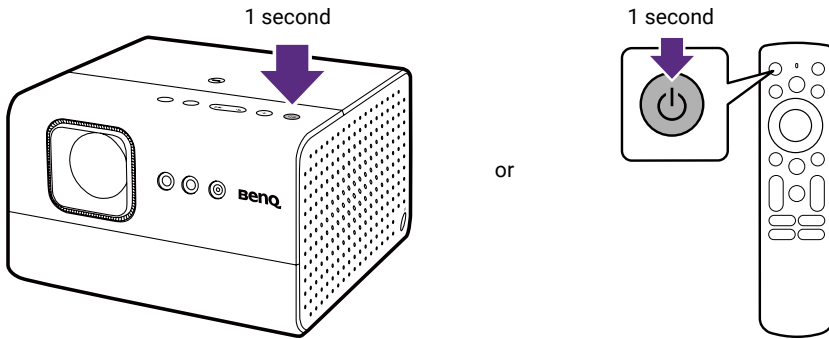

Note

- When supplying power directly to the projector via the supplied power adapter please use the supplied power cable to avoid possible dangers such as electric shock and fire.
 - Prior to pairing the remote control to your projector you must ensure that your remote control is in range of the projector's IR sensor. See "[Remote control effective range](#)" on page 26 for more details.
5. Follow the on-screen instructions to complete the initial set up. Pair your remote control properly in the first step.
 6. When prompted, select **Set up Google TV**. Google TV™ brings together movies, shows, and more from across your apps and subscriptions and organizes them just for you.
 7. In next step, select **Set up on TV instead** on the lower part of the screen to access Google TV.
 8. Check if an updated firmware is available for your product. Refer to "[Upgrading your projector](#)" on page 38.
 9. Go for a preferred scenario.
 - "[Watching streaming videos](#)" on page 49
 - "[Projection](#)" on page 55
 - "[Playing music with your projector](#)" on page 59

Power LED indicator

LED status	Power status
Flashing green	Powering on properly
Solid green	Powered on and ready to use
Flashing orange	Powering off properly
Solid orange	On Standby Mode/Network Standby Mode
Flashing red	Downloading firmware

LED status

Power status

Flashing orange/blue

In Audio Only mode

Power settings and options for saving power

To save power, by default the projector will be automatically switched off when inactive for a period of time.

Time of inactivity	Default setting
15 minutes	The projector enters Network Standby mode.
240 minutes	The projector is powered off.

To manually enable Network Standby mode, briefly press the power key  on the remote control / projector for 1 second.

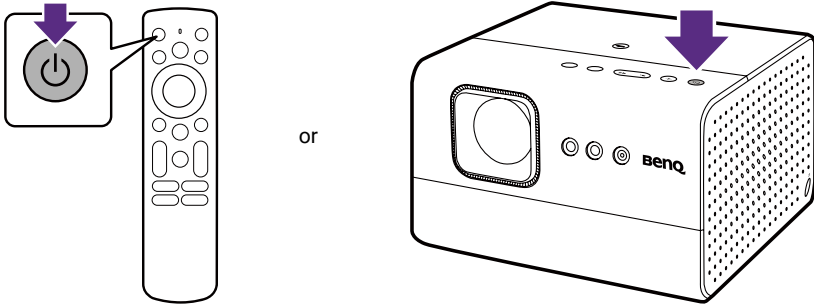

You can change the network standby setting from  > **All settings** > **System** > **Power & Energy** > **Power & Energy** > **Automatically turn off TV when inactive**. This setting does not power off the projector.



To navigate more power menus, go to  > **All settings** > **System** > **Power & Energy**. Set according to your preferences. Here are some settings under **Power** that may help.

Item	Descriptions
Sleep Timer	Allows you to set up a timer to turn off the projector automatically after the set time.
Picture off	Allows you to turn off the light source immediately. To turn on the light source again, press any key.
Switch Off Timer	Allows you to set up a timer to power off the projector automatically after the set time.

Item	Descriptions
Auto Sleep	Allows you to set up a timer to turn off the projector automatically after the set time of inactivity.

Note

The projector is powered off after 4 hours of inactivity by default. If you prefer to extend the standby time, follow the procedures.

1. Go to  > **All settings** > **System** > **Power & Energy** > **Power & Energy** > **Automatically turn off TV when inactive** and select **Never**.
2. Go to  > **All settings** > **System** > **Power & Energy** > **Power** > **Auto Sleep** and select an option that is more than 4 hours.

Shutting down the projector

Press and hold the power key  on remote control / projector for 1 second and the projector will shut down directly.

The power LED will flash orange. The fans may continue to run in order to cool the system.

If the projector will not be used for an extended period, unplug the power cable from the power outlet and remove the batteries from the remote control.

Note

- If you prefer to switch the projector to Network Standby mode automatically, set **Auto Sleep** first. See ["Power settings and options for saving power" on page 35](#) for details.
- The system will automatically enter Standby mode once the power adapter's DC output is connected.

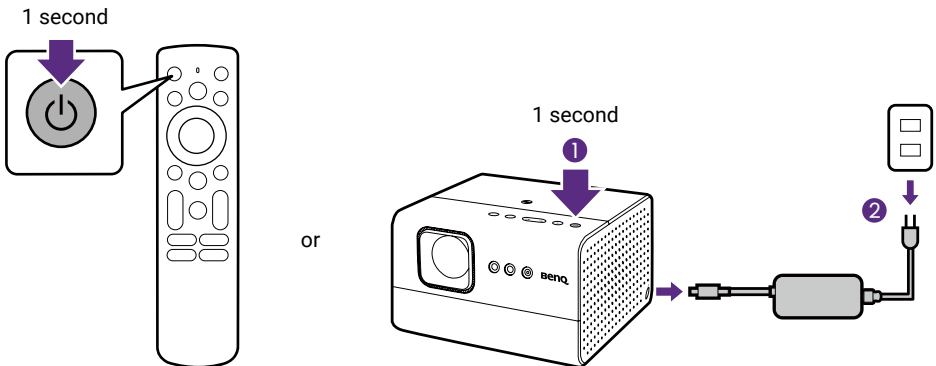

Accessing helpful BenQ apps

You can install certain BenQ apps to extend the functionalities of your projector.

Apps downloaded to your projector

- **BenQ Projector Assistant:** provides tips, FAQs, and product support.
- **Screen Sharing for iOS:** helps cast your content from iOS/macOS device wirelessly. See "[Screen casting from iOS/macOS device devices](#)" on page 55 for more information.

To install apps on your projector, go to the **Apps** tab on the top of your home screen to search for your preferred app.

Download SmartRemoote for BenQ Projector app to your mobile device

SmartRemote for BenQ Projector: pairs your mobile device with the projector to handle basic functions (adjusting volume, moving the directional keys, focusing, etc.), and advanced control of hotkeys for streaming services, text input, and a touchpad, making the usage smarter and more convenient.



Upgrading your projector

It is suggested that you update the projector with the latest version of the firmware to optimize the user experience.

Updating the operating system

When operating system updates are available for your projector, a notification will appear on the Google TV home screen. Follow the on-screen instructions from the notification to complete the update. Notifications will only appear on the home screen when your projector is connected to a wireless network.

Alternatively, go to  > **All settings** > **About** > **System update** to check for update manually.

Advanced firmware updating

If a USB flash drive is required, use one with USB-A connector in FAT32 disk format.

1. Visit [Support.BenQ.com](https://support.benq.com) and download the new firmware files (if available) of your projector. Upgrade procedures may vary by hardware component. Find out the updates and instructions from the upgrade notice. You should download the latest projector user manual for reference as well.
2. Keep stable power supply to the projector via the power adapter. Do not power off the projector.
3. The way to perform advanced firmware update may vary. Refer to the firmware upgrade notice for instructions to complete the upgrade.

Mounting

Tripod mounting (purchased separately)

The projector features three tripod screw holes individually located at the top, bottom, and back. Please ensure that the accessory you purchase separately supports a 1/4" standard screw type and has a minimum weight capacity of at least 4 kg.

Screw location

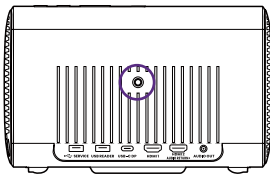

Rear side
Screw type: 1/4"
Screw hole length: 3.5mm

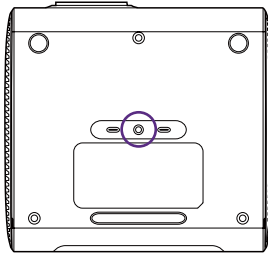

Bottom side
Screw type: 1/4"
Screw hole length: 7mm

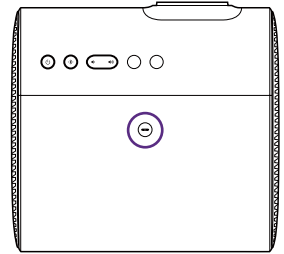

Top side
Screw type: 1/4"
Screw hole length: 7mm

Flexible setup

With the three tripod screw holes, you can easily mount the projector on a tripod (purchased separately) for flexible setup to accommodate different room settings.

- Front projection

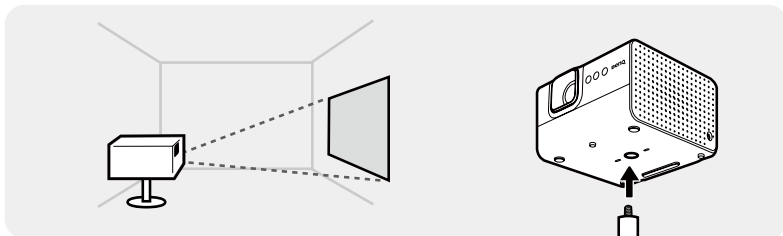

- Upside down projection

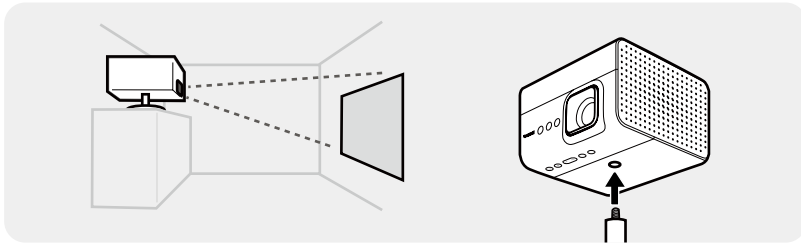

- Projection onto ceiling

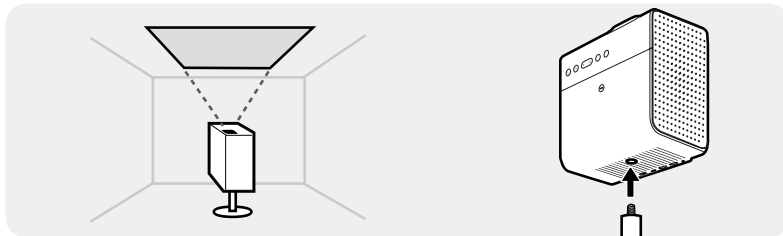

Work with more screen adjustment functions to fine tune your projection when projecting your image onto ceiling.

- "Projection size and position adjustment (Digital zoom and image reposition)"
- "Image rotation"

Note

For ceiling projection, please attach a stand and ensure that the back of the projector is at least 5 cm away from the table to prevent exhaust blockage.

Working with a tripod plate

To use a tripod plate to mount the projector onto a tripod:

1. Install the tripod's quick release plate to the projector's tripod screw hole and tighten the plate's screw.

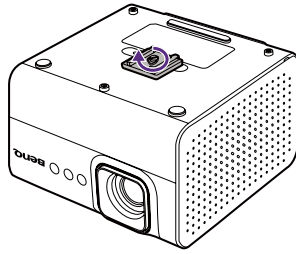

2. Install the projector onto the tripod.

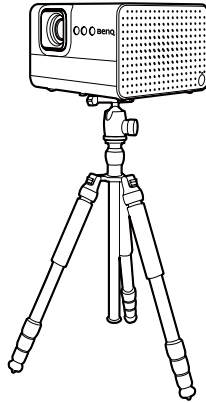

Ceiling mounting

The projector features installation points on the bottom for a traditional ceiling mount. Please ensure that the ceiling mount you purchase separately supports an M4 screw type and has a minimum weight capacity of at least 4 kg.

Note

The projector is compatible with the BenQ CM00G3 universal ceiling mount.

Screw location

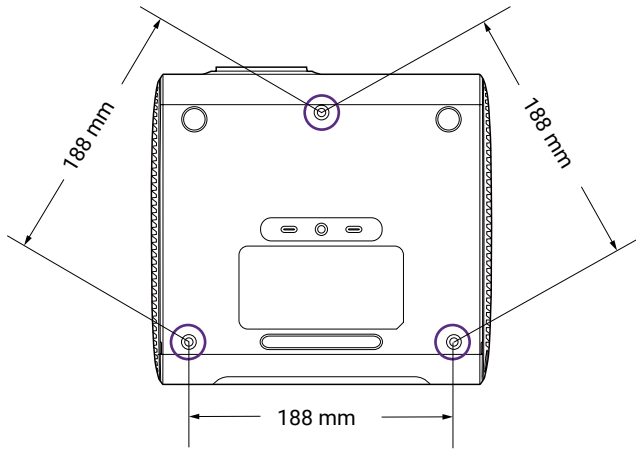

Screw type: M4
Screw hole length: 7mm

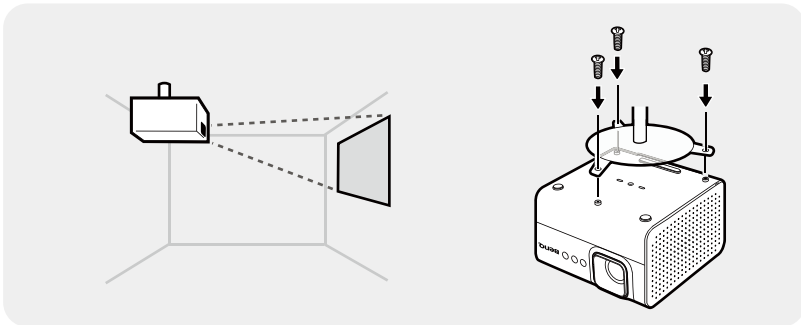

Adjusting the projected image

Fine-tuning the image clarity

To sharpen the picture, adjust the focus.

- **Real-time focus & keystone adjustment:** Your projector adjusts focus and keystone automatically at startup by default. This function will be performed automatically as well when the projector is moved. To check/change the auto focus setting, go to **⚙️ > All settings > Projector > Focus > Advanced**. The effective distance from the projection lens to the screen is 1.3 – 4.9 meters.
- **One-click screen adjustment:** Press the  button on the remote control and the projector will automatically focus the image and adjust keystone. Make sure the full keystone pattern is displayed on the screen to ensure a successful correction.

Note

When Picture Mode is set to Auto Cinema, pressing the  button on the remote control will activate both the screen adjustment function and the Auto Cinema mode setting.

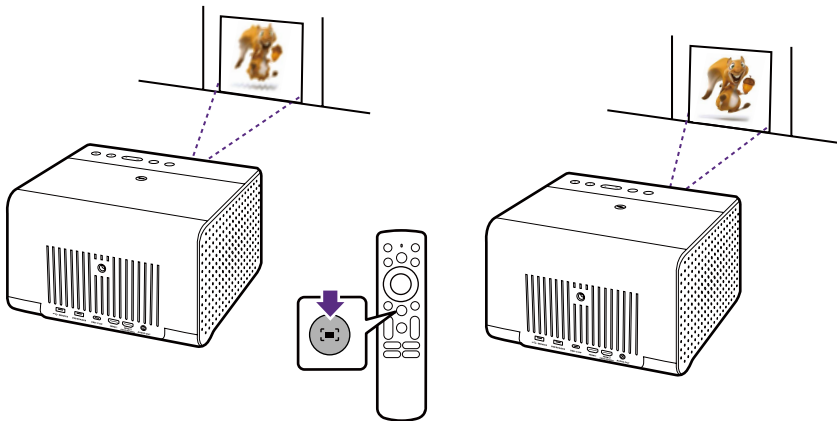

- **Manual focus:** Go to **⚙️ > All settings > Projector > Focus > Manual Focus**. Press up/down keys to make adjustment. When the focus is completed, press **←** to leave.

Note

A focus pattern is displayed to ensure image focus adjustment by default. It is recommended to display the focus pattern for better focus adjustment during video playback in particular. If you prefer not to be distracted by the pattern during adjustment process, you can manually disabled the pattern from **⚙️ > All settings > Projector > Focus > Advanced > Deep Focus Always On**.

Fitting the image to your screen

Keystone

The keystone effect refers to the situation where the projected image is noticeably wider at the top / bottom / left / right. It occurs when the projector is not perpendicular to the screen. The screen automatically performs keystone correction after the projector moves. Make sure the keystone pattern is completely visible on the screen to ensure a successful correction.

- **Real-time focus & keystone correction:** Your projector adjusts focus and keystone automatically at startup if enabled. This function will be performed automatically as well when the projector is moved. To check/change the auto keystone setting, go to **⚙️ > All settings > Projector > Image Correction > Advanced**. The effective range of auto keystone is as follows:
 - Vertical: ± 20 degrees
 - Horizontal: ± 40 degrees
 - Rotation: ± 30 degrees
 - Distance from lens to wall: 2 meters

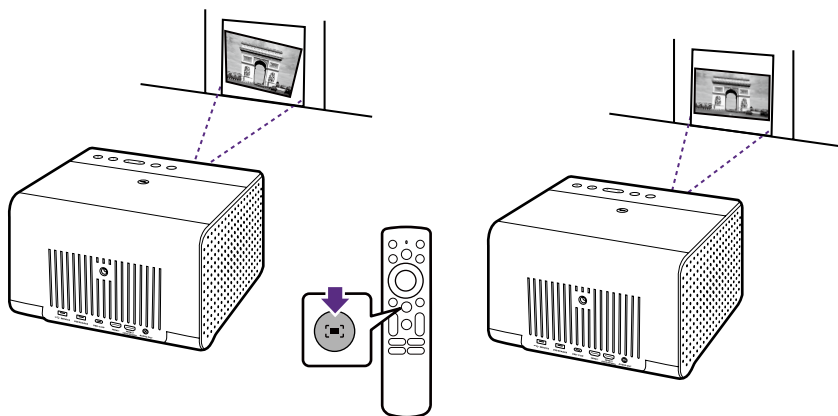



- **One-click screen adjustment:** Press the **[⏏]** button on the remote

control and the projector will automatically focus the image and adjust keystone. Make sure the full keystone pattern is displayed on the screen to ensure a successful correction.

Note

When Picture Mode is set to Auto Cinema, pressing the  button on the remote control will activate both the screen adjustment function and the Auto Cinema mode setting.

- **Manual keystone:** Go to  > **All settings** > **Projector** > **Image Correction** > **Manual Keystone Correction**. Simply follow the on-screen instructions to make adjustments. When the adjustment is completed, press  to save your changes and return to the previous menu. The effective range of manual keystone is as follows:
 - Vertical: ± 40 degrees
 - Horizontal: ± 40 degrees
 - Rotation: ± 30 degrees
 - Distance from lens to wall: 2 meters

Note

The way to adjust keystone varies by projection distance and the displayed pattern varies accordingly. This will not change the corrected result, however.

Screen Fit

If the projector is placed off-centered, the image may be distorted and exceeded your screen. With the Screen Fit function, you can adjust the image to align with 4 borders of the screen to fit the screen properly. Note that the Screen Fit function works only when at least two borders of the screen are detected by the focus/keystone camera.

1. Make sure the projection covers the whole screen and is larger than the screen.
2. Go to  > **All settings** > **Projector** > **Image Correction** > **Fit to Screen**.
3. Follow the on-screen instructions. Make sure the full keystone pattern is displayed on the screen to ensure a successful correction. The projection will fit into the screen automatically.

Tip

To perform this function automatically, go to  > **All settings** > **Projector** > **Image Correction** > **Advanced** > **Auto fit to Screen**. Toggle the switch on.

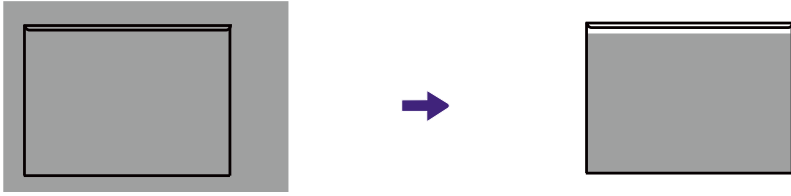

Obstacle avoidance

With this function, the projector detects if the screen is shaded by any object, and resizes the projected image automatically to avoid the object. Go to **⚙️ > All settings > Projector > Image Correction > Advanced > Avoid Obstacles**. The projector will automatically resize to avoid the object shading the screen. Make sure the full keystone pattern is completely displayed on the screen to ensure a successful correction.

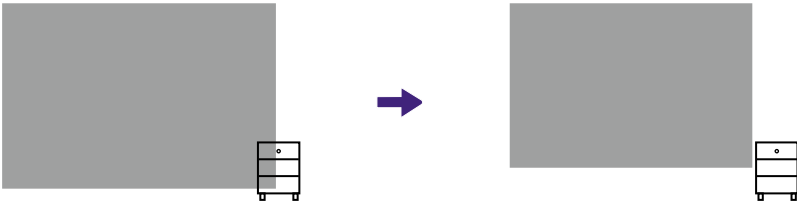

Note

The **Auto fit to Screen** and **Avoid Obstacles** functions cannot work together. The correction result will be based on screen detection.

Projection size and position adjustment (Digital zoom and image reposition)

Resize and shift the projected image to fit your space with the digital zoom and reposition functions easily.



1. To resize an image to a smaller space, press the digital zoom in/out keys on the remote control. The maximum size is the image you projected in the first place.
2. Press OK to switch to image reposition function. Use the arrow keys on the remote control to move the image. Follow the on-screen instructions to switch between digital zoom and image reposition.
3. Press **←** to save and exit.

Tip

To access the menu, go to  > **All settings** > **Projector** > **Image Correction** > **Image Adaption**.

Image rotation

Use the image rotation function to fit your room layout or viewing angle.

1. Go to  > **All settings** > **Projector** > **Image Correction** > **Image Rotation**.
2. Follow the on-screen instructions to rotate the image.
3. Press  to save and exit. Or press and hold OK to reset.

Adjusting screen brightness

Go to  > **All settings** > **Display & Sound** > **Picture** > **Brightness**.

Item	Descriptions
Normal	Provides full light brightness.
ECO	Lowers brightness to extend the light life and decreases the fan noise.
Dynamic	Adjusts the light power automatically depending on the content brightness level while optimizing display quality.
Custom	Ten levels of brightness are provided to decrease the current peak brightness.

Activating smart eye protection

This function reduces the screen brightness when an object/person is detected within 2 meters in front of the projection lens.

To activate this function, go to  > **All settings** > **Projector** > **Advanced Settings** > **Smart Eye Protection**.

Optimizing image quality by Auto Cinema mode

Auto Cinema mode allows the projector to automatically optimize the image quality by adjusting parameters such as saturation, brightness, contrast, and sharpness in real time based on changes in environmental conditions, e.g., ambient light, projector position, screen distance, and the color of the wall to which the image is projected.

Auto Cinema mode can be triggered by moving the projector or pressing the screen adjustment button on the remote control. Under these circumstances the projector will project the calibration pattern and automatically optimize the aforementioned image parameter settings. Auto Cinema mode is available between a projection distance of 1.6 and 4.0 meter.

Auto Cinema mode is the default picture mode. Go to  > **All settings** > **Display & Sound** > **Picture** > **Picture Mode** to switch picture mode.

Changing the input source

By default, the projector will display the Google TV home screen any time it is powered on.

Connect a device to one of the projector's input ports. Press the source key  on the remote control and select the desired input source from the source menu.

You can also press the home button  on the remote control to return to the Google TV home screen at any time.

Note

A USB flash drive is not considered as an input source. To play files from a USB flash drive, see ["Playing multimedia files from a USB flash drive" on page 63.](#)

Watching streaming videos

Make sure the projector has been connected to a wireless network and you are signed into your Google Account.

Google TV home screen

Upon initial startup or when you press the  key on the remote control, the projector will display the Google TV home screen.

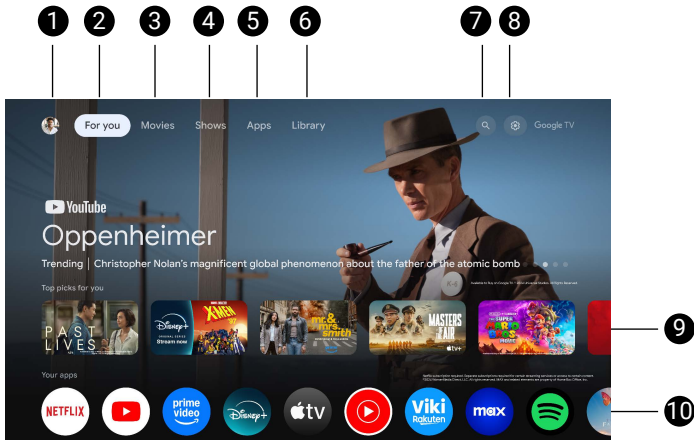

Note

Actual screen and features may vary depending on your country/region.

No.	Item	Description
1	Profile	Signed-in profile.
2	For You	Access to home screen.
3	Movies	Browse a variety of movies.
4	Shows	Explore an assortment of shows.
5	Apps	Download new apps or access installed apps.
6	Library	Access to your personalized watchlist.
7	Search	Enables text input to search.
8	Dashboard	Quick access to setting menu and certain functions (See page 50).

No.	Item	Description
9	Recommendations	Discover movies and shows from across your apps with personalized suggestions.
10	Your Apps	Browse your installed apps.

Dashboard

Use the side panel dashboard to quickly access certain functions and settings.

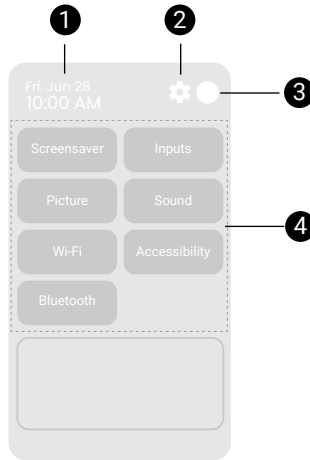

No.	Item	Descriptions
1	System time	Displays the time.
2	Settings	Access to the settings menus.
3	Profiles	Switch to different user profiles.
4	Default frequently used menus	Access to frequently used menus/functions.

Note

Actual screen may vary by the availability of network and Google TV version. It may also subject to change without prior notice.

Choosing a proper picture mode for video streaming

You are provided with a variety of picture modes for different scenarios in **Picture Mode**. Go to  > **All settings** > **Display & Sound** > **Picture** for selection. Usually **Cinema** is recommended for watching movies. Available options vary by content. When HDR/HLG/HDR10+ content is available, some options under **Picture** support HDR/HLG/HDR10+ content. Compared to its standard picture mode, an HDR mode helps deliver High Dynamic Range effects with higher contrasts of brightness and colors.

Option	Descriptions
Bright	Maximizes the brightness of the projected image. This mode is the brightest mode on your projector.
Cinema	With accurate colors and deepest contrast at a lower brightness level, this mode is suitable for playing movies in an environment with a bit of ambient light.
Auto Cinema / HDR-Auto Cinema	Automatically adjusts color settings based on wall color, ambient light, and screen size. In an environment with a bit of ambient light, this mode is suitable for playing movies with authentic colors and deepest contrast at a lower brightness level. Under a small amount of ambient light, this mode is suitable for playing streaming TV with well-saturated colors and fine-tuned sharpness. See "Optimizing image quality by Auto Cinema mode" on page 47 for more information.
Game / HDR-Game	Picture settings appropriate for playing video games. This mode especially enhances details in dark scenes so that enemies cannot hide. Note Noise reduction is not available in Game mode.
Sport	With well-saturated colors, this mode is best for watching sporting events.
User / HDR-User / HDR10+ User / HLG-User	Accesses the customized settings.

Option	Descriptions
HDR10	Delivers High Dynamic Range effects with higher contrasts of brightness and colors.
HDR10+	Delivers High Dynamic Range effects with higher contrasts of brightness and colors especially for HDR Blu-ray movies.
HLG	Delivers Hybrid Long Gamma effects by adding a logarithmic curve with extra brightness over the top of the signal.

Choosing a proper sound mode for video streaming

In general, you can select a sound mode from **Sound Mode** to suit your scenario. Go to  > **All settings** > **Display & Sound** > **Sound** for selection. Usually **Cinema** is recommended for watching movies.

Option	Descriptions
Cinema	This mode balances the background music and movie sound effect and especially enhances vocal dialogue for clear whispered voices and stereo bass sound effect for explosive action scenes, such as gunshots and firefights.
Music	This mode emphasizes total balance (low, middle, and high frequency) to fully display the timbre of musical instruments, rhythm of symphonies, and solos of singers in hot concerts or in live halls for different types of music, like pop, rock, and jazz.
Game	This mode emphasizes clear position and spatial dynamic to enhance directional sound; therefore game players can recognize the direction of gunshots or footsteps from right to left so that enemies cannot hide when in an action or fighting game.

Option	Descriptions
Sport	This mode allows users to enjoy the rich vividness of sport broadcasts and light entertainment programs. The commentators' voice is clear and high pitch shrill cheers from the audience is processed.

Enhancing gaming experience

To enhance your gaming experience, you are provided with picture and sound modes that are suitable for gaming. In general, **Game / HDR-Game** (picture mode) and **Game** (sound mode) are recommended for gaming.

Auto Low Latency Mode (ALLM)

Auto Low Latency Mode (ALLM) is designed to provide a smooth gaming experience with low input lag. It allows the projector to automatically switch to low latency mode when it detects gaming signals sent from a gaming console, PC, laptop, or other device. In low latency mode, once the projector detects the gaming signal has ended, it will return to its standard display mode.

ALLM is only available when the input source is HDMI and the picture mode is set to **Game** or **HDR-Game**.

ALLM is disabled by default. To enable this function, go to  > **All settings** > **Display & Sound** > **Picture** > **Expert Settings**.

Game mode boost

When you have already set the picture mode to **Game** or **HDR-Game** and want to have an even more responsive gaming experience, go to  > **All settings** > **Display & Sound** > **Picture** > **Expert Settings** to enable **Game Mode Boost**.

Note

- **Game Mode Boost** is available only when **Picture Mode** is set to **Game** or **HDR-Game** and the input source is either HDMI or USB-C.
- Once **Game Mode Boost** is enabled, the keystone correction value will be automatically set to zero. Therefore, before enabling **Game Mode Boost**, ensure the project is placed perpendicular to the screen.
- To use the keystone correction function in the **Game** or **HDR-Game** mode, go to **All settings** > **Display & Sound** > **Picture** > **Expert Settings** to disable **Game Mode Boost**.

Projection

Wireless projection (screen casting)

To screen cast from your mobile device, tablet or computer to your projector, ensure that both devices are connected to the same wireless network.

Depending on your mobile device, different procedures and options are required. Follow the instructions.

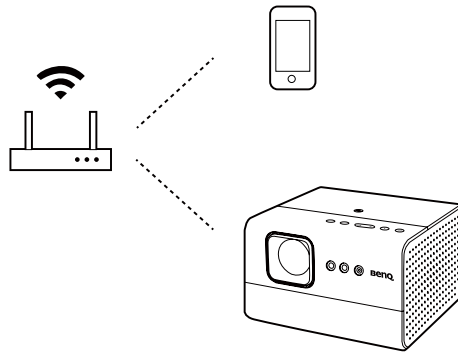

Screen casting from iOS/macOS device devices

1. Install and launch the **Screen Sharing for iOS** app from **Settings > All settings > Projector > Advanced Settings > Screen Sharing for iOS**.
2. Go to **Apps** from the Google TV home screen on the projector, and launch the **Screen Sharing for iOS** app.

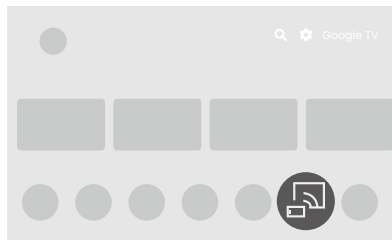

3. Follow the on-screen instructions to grant the access right.

4. Make sure your mobile device and the projector are connected to the same wireless network.
5. Enable the screen mirroring function from your iOS/macOS device. Choose **GP01** (the default device name of your projector) from the device list. If you have changed the name, look for the new name from the device list.

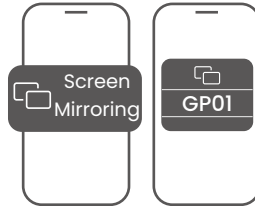

Tip

Some of the streaming apps use portrait screens only and may not be projected in full screen in a landscape projection. You can press the left / right key to rotate the screen when casting an iOS/ MacOS device.

Screen casting from Android™ OS devices with Google Cast™

1. Make sure your mobile device and your projector are connected to the same wireless network.
2. Open a Google Cast-enabled app on your mobile device.
3. Select the content you would like to cast from your mobile device to your projector.
4. Tap the Cast icon (📺) on your mobile device and select **GP01** (the default device name of your projector) as the device you would like to cast to.

Screen casting from Android™ OS devices with Google Home

1. Make sure your mobile device and the projector are connected to the same wireless network.
2. Go to **Google Play** on your mobile device. Install and launch the **Google Home** app.
3. Follow the on-screen instructions. Select **GP01** (the default device name of your projector) as your cast device from **Google Home** to

enable the screen mirroring function from your mobile device. If you have changed the name, look for the new name from the device list.

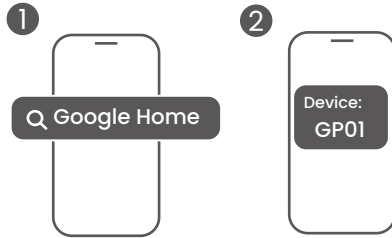

Screen casting from PC devices with Google Cast™

1. Make sure your computer and the projector are connected to the same wireless network.
2. Enable the screen mirroring (cast) function from the browser (e.g. Chrome) of your computer. Available name and access to the screen mirroring function may vary by program. Note that the projector is named **GP01** by default. If you have changed the name, look for the new name from the device list.

Windows

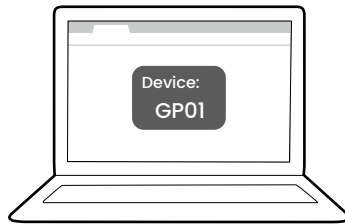



Wired projection

Using an HDMI or certified USB-C 3.0 cable you can connect a device that is equipped with HDMI or DP Alt Mode capabilities to broadcast videos or images on the projector.

Note

Not all devices with a USB-C port have DisplayPort functionality. Check your device's documentation for clarification.

1. Connect the device to the HDMI or USB-C port on the projector with a certified cable.
2. Press the source key , and then select the corresponding port in the source menu.
3. Use the source menu or press the home button  to exit and go back to the Google TV home screen.
4. If the device remains connected and you want to project its video again, press the source button , and then select the corresponding port in the source menu.

Note

- Some computers feature HDMI ports that do not transmit audio. In such cases a separate audio cable must be connected to the projector.
- Some laptops do not turn on their external video ports when connected to a projector. Usually a key combination like Fn + F3 or CRT/LCD key turns the external display on/off. Locate a function key labeled CRT/LCD or a function key with a monitor symbol on the laptop. Press Fn and the labeled function key simultaneously. Refer to your laptop's documentation to discover your laptop's key combination.

Tip

Your projector features video/audio transfer and power delivery from the USB-C port. With this feature, you can charge your gaming console (with USB-C video output) directly during gaming without any other docking. See ["Power delivery to a USB-C device" on page 64](#) for details.

Playing music with your projector

With the built-in speakers, you can enjoy music playback via the projector without a projection screen. The projector can work as an ordinary speaker or a wireless speaker.

Making your projector a Bluetooth speaker

Available when input source is set to Google TV.

1. Press the Bluetooth speaker mode button (🔊) on the projector to enable projector's Bluetooth function. Alternatively, go to ⚙️ > **All settings** > **Projector** > **Bluetooth Speaker Mode**. The screen is turned off.
2. Enable your device's Bluetooth function as well. Select **GP01** (the default device name of your projector) from the device list for pairing. If you have changed the name, look for the new name from the device list.
3. After the pairing is done successfully, you can output the audio from your device to the projector.
4. To stop the music playback from the projector and disconnect Bluetooth connection, press any key and press and hold the back button ← on the remote control.

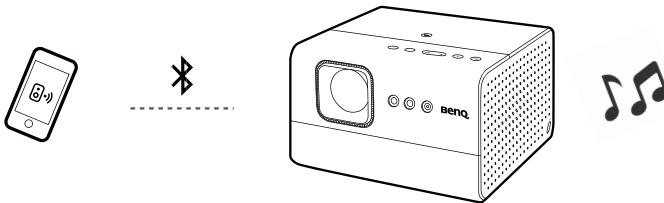

Note

The projector does not support automatic re-connections with previously paired devices. In order to re-connect to a paired device or connect to another device, repeat the steps above.

Using the Bluetooth speaker mode button

You can also make your projector a Bluetooth speaker by pressing the Bluetooth speaker mode button (Ⓜ) on the the projector. When in the Bluetooth speaker mode, press the Bluetooth speaker mode button (Ⓜ) again for 2 seconds to return to Google TV mode.

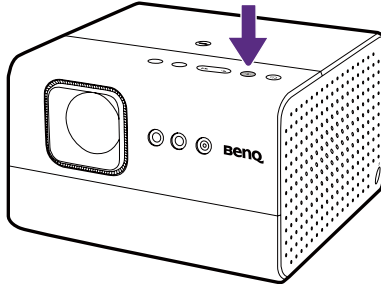

Bluetooth speaker mode LED indicator

Scenario	LED status	Bluetooth status
Switching to Bluetooth speaker mode, or pairing and connecting a Bluetooth device	Flashing blue	Bluetooth speaker mode enabled Waiting for Bluetooth device to pair and connect
	Solid blue	Bluetooth device pairing and connecting in progress Bluetooth device connected successfully
Disconnecting and unpairing a Bluetooth device	Flashing blue	Bluetooth device unpairing and disconnecting in progress
		Bluetooth device disconnected
Exiting Bluetooth speaker mode	Off	Off

Connecting the projector to an external Bluetooth speaker / headphone

Available when input source is set to Google TV.

1. Go to  > **All settings** > **Remotes & Accessories** > **Pair accessory** on your projector.
2. Activate Bluetooth-pairing mode on the speaker or headphones.
3. Select the speaker / headphones from the device list.
4. Select **Pair**.
5. Once the projector and speaker / headphones have successfully connected, you can output the audio from your projector to the speaker / headphones.

Note

The projector does not support automatic re-connections with previously paired devices. In order to re-connect to a paired device or connect to another device, repeat the steps above.

Making your projector a wireless speaker

1. Power on the projector (see ["Powering on and initial setup" on page 32](#)).
2. Connect your mobile device and the projector to the same wireless network.
3. Cast your audio from the mobile device to the projector as instructed in ["Wireless projection \(screen casting\)" on page 55](#).
4. Press and hold  on the remote control (if paired in initial setup) for 2 seconds to enable audio-only mode. See ["Turning the screen off during music playback"](#) for details.
5. Launch the music app on your mobile device and use the casting function through Google Cast as instructed in ["Wireless projection \(screen casting\)"](#). Find **GP01** as the casting device to enjoy music streaming.

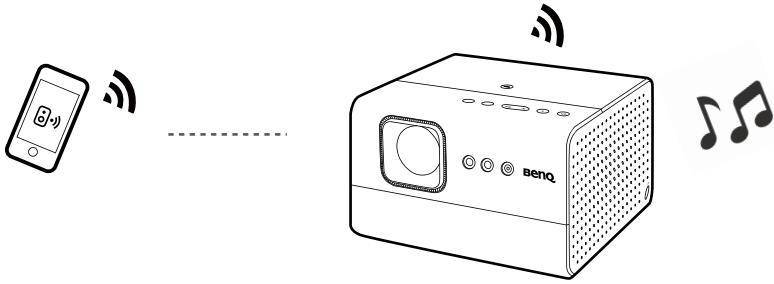

Turning the screen off during music playback

You can enjoy music playback via the projector without a projection screen.

Press and hold the  button on the remote control (if paired in initial setup) to switch the projector to audio-only mode. The screen is turned off while the music playback continues.

You can adjust volume by pressing the volume adjustment keys without a projection screen.

To stop the playback or to perform other operations, press any key (except power, projector assistant key () , and volume adjustment keys) on the remote control to bring the projection screen back.

Playing multimedia files from a USB flash drive

A media reader app required. Install one before accessing files from a USB flash drive.

To play media files stored on a USB flash drive, you must make connections and settings properly.

1. Connect your USB flash drive to the USB-A / USB-C port of the projector.
2. You are prompted when the USB storage device is detected. Follow the on-screen instructions. On the home screen go to **Apps** > search "media player" and download a preferred app.
3. Launch a media reader app on your projector to access the multimedia files stored on your USB flash drive. Supported file formats for playback may vary by app.

Note

Supported USB flash drive formats: NTFS, FAT, and FAT32.

Power delivery to a USB-C device

Available only when the projector is supplied power via the included power adapter.

With the power delivery function, your projector is able to supply power to a connected USB-C device certified by USB-IF.

Supported USB-C power delivery:

- 5V/2A
- 9V/2A
- 12V/1.5A
- 15V/1.2A

USB-C power delivery notice

- The information is based on the standard testing criteria and is provided for reference. The compatibility is not guaranteed as the user environments vary. When a separately purchased USB-C cable is used, make sure the cable is certified by USB-IF and is full-featured with power delivery function.
- A connected device needs to be equipped with a USB-C connector that supports charging function via USB power delivery.
- If the connected device requires more than the power supplied by your projector for operation or for boot up (when the battery is drained), use the original power adapter that came with the device.

Menu navigation

To let you make various adjustments or settings on the projector, the projector provides a settings menu. To access the menu, go to  > **All settings**.

Actual menu and options may vary depending on your country/region. Here are some menus related to projector settings. Visit <https://tv.google/> for more information on menus and options.

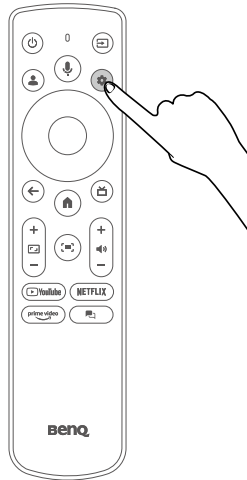

Set your device name

You can change the projector's name if desired.

Projector

 > **All settings** > **Projector**

Item	Options and descriptions
Focus	Decides whether to adjust focus automatically or manually.
Image Correction	Allows you to correct keystone and fit the screen.

Item	Options and descriptions
	<p>Auto Keystone Correction Allows you to perform keystone correction automatically. See "Keystone" on page 44.</p> <p>Manual Keystone Correction Allows you to perform keystone correction manually. See "Keystone" on page 44.</p> <p>Fit to Screen Fits the image to a screen. See "Screen Fit" on page 45.</p> <p>Image Adaption Changes the size and/or adjusts the position of the projected image. See "Projection size and position adjustment (Digital zoom and image reposition)" on page 46.</p> <p>Image Rotation Rotates the image to suit your viewing angle. See "Image rotation" on page 47.</p> <p>Reset to Default Image Resets the image adjustments.</p> <p>Advanced Allows you to perform various image adjustments automatically.</p>
Bluetooth Speaker Mode	Enables the projector's Bluetooth speaker mode. See "Making your projector a Bluetooth speaker" on page 59.
Advanced Settings	<p>Accesses the advanced projector functions.</p> <p>Screen Sharing for iOS Installs or launches the Screen Sharing for iOS app for screen casting from an iOS/macOS device. See "Screen casting from iOS/macOS device devices" on page 55.</p> <p>Smart Eye Protection Lowers image brightness when a person is detected near the projection lens to protect eyes. See "Activating smart eye protection" on page 47.</p>

Item	Options and descriptions
	<p>Projection Mode Decides the installation location of your projector. See "Choosing a location" on page 27.</p> <p>Remote Control Accesses remote control information, including remote control battery level and firmware upgrade.</p> <p>Advanced Firmware Update Upgrades the MCU firmware from a USB-A device connected to the service USB Type-A port.</p> <p>Clear Cache Helps to free memory space to improve projector performance.</p> <p>More</p> <ul style="list-style-type: none"> • Enables High Altitude Mode. See "Using the projector at high altitude" on page 30. • Displays the amount of time (in hours) that the light source has been used.

Display & Sound

 > All settings > Display & Sound

Item	Options and descriptions
Picture	<p>Adjusts picture image settings.</p> <p>Brightness Allows you to adjust screen brightness. See "Adjusting screen brightness" on page 47.</p> <p>Picture Mode Allows you to choose a proper picture mode for the content. See "Choosing a proper picture mode for video streaming" on page 51.</p> <p>Expert Settings Adjusts settings to enhance image quality.</p>

Item	Options and descriptions
	<p>3D Mode Allows you to select the appropriate format for your 3D content such as side-by-side, top-and-bottom, and Blu-ray 3D.</p> <p>Note There will be a brief black screen during the switching process. Image Correction, Picture Mode, Bluetooth Speaker Mode, Projection Mode, ALLM, and Screen settings are not available in 3D Mode.</p> <p>Reset to Default Resets image settings to factory defaults.</p>
Screen	<p>Allows you to adjust the aspect ratio of the projected image.</p> <p>Note This setting is not available when the projector is in Google TV mode.</p>
Sound	<p>Sound Mode Allows you to choose a proper sound mode for the content. See "Choosing a proper sound mode for video streaming" on page 52.</p> <p>Expert Settings Allows you to enable the Audio Volume Control and eARC functions.</p>
Audio Output	<p>Allows you to select the audio format and output delay from the source device connected to the HDMI port.</p> <p>When the digital output setting is Auto, the projector detects the format of input content and set audio format automatically.</p>

Network & Internet

> All settings > Network & Internet

Sets the network connection. You can activate or deactivate wireless connection.

Accounts & sign-in

 > **All settings** > **Accounts & sign-in**
Manages accounts.

Privacy

 > **All settings** > **Privacy**
Manages your privacy settings.

Apps

 > **All settings** > **Apps**
Manages the installed apps.

System

 > **All settings** > **System**
Accesses device settings.

Remotes & Accessories

 > **All settings** > **Remotes & Accessories**
You can manually pair a remote via Bluetooth, or manage a paired device.

Maintenance

Care of the projector

Your projector needs little maintenance. The only thing you have to do on a regular basis is to keep the lens clean.

Never remove any parts of the projector. Contact your dealer or local customer service center if the projector fails to operate as expected.

Cleaning the lens

Clean the lens whenever you notice dirt or dust on the surface. Please be sure to turn off the projector and let it cool down completely before cleaning the lens.

- Use a canister of compressed air to remove dust.
- If there is dirt or smears, use lens-cleaning paper or moisten a soft cloth with lens cleaner and gently wipe the lens surface.
- Never use any type of abrasive pad, alkaline/acid cleaner, scouring powder, or volatile solvent, such as alcohol, benzene, thinner or insecticide. Using such materials or maintaining prolonged contact with rubber or vinyl materials may result in damage to the projector surface and cabinet material.

Note

Never use wax, alcohol, benzene, thinner or other chemical detergents. These can damage the case.

Storing the projector

If you need to store the projector for an extended time, please follow the instructions below:

- Make sure the temperature and humidity of the storage area are within the recommended range for the projector. Please refer to "[Specifications](#)" on page 75 or consult your dealer about the range.
- Remove the batteries from the remote control.
- Pack the projector in its original packing or equivalent.

Transporting the projector

It is recommended that you ship the projector with its original packing or equivalent.

Light source information

To check the light usage time, go to  > **All settings** > **Projector** > **Advanced Settings** > **More** > **Light Source Information**.

Troubleshooting

 The LED indicator is flashing.

Power LED status	Scenario
Solid red	Fan error
Flashing red/green	Temperature error
Flashing orange/green	Light source life exhausted
Flashing green/purple	DLP communication error
Flashing purple/red	G-sensor error
Solid purple	Driver board error
Flashing purple	TOF sensor error

Contact customer service for assistance.

Note

Refer to ["Power LED indicator" on page 33](#) for power LED indicator details.

 The projector does not turn on.

Possible cause	Remedy
There is no power from the power cord.	Plug the power cord into the AC power jack on the projector, and plug the power cord into the power outlet. If the power outlet has a switch, make sure that it is switched on.
Attempting to turn the projector on again during the cooling process.	Wait until the cooling down process has completed.

? No picture.

Possible cause	Remedy
The video source is not turned on or connected correctly.	<ul style="list-style-type: none">• Check if the video source is properly connected.• The projector may be in Audio-only or Network Standby mode. Press the power key to disable.
The projector is not correctly connected to the input signal device.	Check the connection.
The input signal has not been correctly selected.	Select the correct input signal with the  key.

? Blurred image

Possible cause	Remedy
The projection lens is not correctly focused.	Manually adjust the focus of the lens. See "Fine-tuning the image clarity" on page 43.
The projector and the screen are not aligned properly.	Adjust the projection angle and direction as well as the height of the projector if necessary.
The auto keystone function did not work.	Adjust the projection angle.
The ToF sensor is dirty.	Clean the sensor gently with a cleaning cloth. Remove dust or fingerprint carefully.

? Remote control does not work.

Possible cause	Remedy
The batteries are out of power	Replace both of the batteries with new ones.
There is an obstacle between the remote control and the projector.	Remove the obstacle.

Possible cause	Remedy
You are too far away from the projector	Stand within 8 meters (26 feet) of the projector.

Specifications

Projector specifications

Category	Item	Descriptions
Display	Brightness (ANSI lumens)	2600
	Native Resolution	UHD (3840 x 2160)
	Native Aspect Ratio	16:9
	Contrast Ratio (FOFO)	200,000:1
	Display Color	30 Bits (1.07 billion colors)
	Light Source	LED
	Light Source Life	Eco: 30000 hours Normal: 20000 hours
Optical	Throw Ratio	1.2
	Zoom Ratio	Fixed
	Lens	F/# = 1.7, f = 12.617 mm
	Projection Offset (Full-Height)	100%
	Keystone Adjustment	- (Auto) Vertical: ± 20 degrees, Horizontal: ± 40 degrees - (Manual) Vertical & Horizontal: ± 40 degrees - (Auto / Manual) Rotation: ± 30 degrees
	Clear Image Size	50" – 113"
Projection Size	50" – 180"	
Picture	Rec. 709 Coverage	98%
Compatibility	Resolution Support	VGA (640 x 480) to 4K UHD (3840 x 2160)
	Horizontal Frequency	15 kHz – 135 kHz
	Vertical Scan Rate	23 Hz – 240 Hz
	HDTV Compatibility	480i, 480p, 576i, 567p, 720p, 1080i, 1080p, 2160p
I/O Interface	HDMI in	(x2) - HDMI-1 (Auto low latency mode / CEC) - HDMI-2 (Auto low latency mode / CEC / Audio Return+ with multichannel audio output)
	USB Type-A	(x2) - USB-A-1 USB 2.0: For service only. Does not support 5V power supply - USB-A-2 USB 2.0 (5V 1.5A): Power supply (up to 5V/1.5A) / USB reader / Firmware upgrade
	USB Type-C	(x1) Display Port 1.4 / PD output 5V (2A) / 9V (2A) / 12V (1.5A) / 15V (1.2A) / Media reader USB 2.0

Category	Item	Descriptions
Audio	Speaker	(x2) 12 W
	Audio out (3.5mm Mini Jack)	(x1)
	HDMI Audio Return+	eARC, bypass 5.1 channel, 7.1 channel, Atmos
Environment	Power Supply	AC 100 V to 240 V, 50 Hz / 60 Hz
	Power Consumption	Typical 186 W, Max. 250.08 W
	Power consumption in networked standby / standby mode	2 W / < 0.5 W
	Acoustic Noise (Typ./Eco.)(dB)	26 dBA / 24 dBA
	Operating Temperature	0°C – 40°C
	Storage Temperature	-20°C – 60°C, without condensation
	Operating Relative Humidity	10% – 90% RH, without condensation
	Storage Relative Humidity	10% – 90% RH, without condensation
Smart Features	Bluetooth	Bluetooth 5.2
	Wi-Fi Standard	802.11 a/b/g/n/ac/ax (2.4G / 5G / 6G)
Dimensions and Weight	Net Weight (kg)	3.7 kg
	Net Weight (lb)	8.2 lb
	Dimensions (WxDxH) (mm)	241.3 (W) x 225.0 (D) x 151.0 (H)
	Dimensions (WxDxH) (inch)	9.49 (W) x 8.86 (D) x 5.94 (H)
Projections System	Projection System	DLP
	DMD size	0.47"

Note

- LED life results will vary depending on environmental conditions and usage.
- The performance of Wi-Fi and Bluetooth might be disturbed by distance and obstacles.

Timing chart

HDMI input

PC

Resolution	Mode	Vertical frequency (Hz)	Horizontal frequency (KHz)	Dot Clock Frequency (MHz)
640 x 480	VGA_60	59.940	31.469	25.175
720 x 400	720 x 400_70	70.087	31.469	28.3221
800 x 600	SVGA_60	60.317	37.879	40.000
1024 x 768	XGA_60	60.004	48.363	65.000
1280 x 720	1280 x 720_60	60	45.000	74.250
1280 x 768	1280 x 768_60	59.870	47.776	79.5
1280 x 800	WXGA_60	59.810	49.702	83.500
1280 x 1024	SXGA_60	60.020	63.981	108.000
1280 x 960	1280 x 960_60	60.000	60.000	108
1440 x 900	WXGA+_60	59.887	55.935	106.500
1400 x 1050	SXGA+_60	59.978	65.317	121.750
1600 x 1200	UXGA	60.000	75.000	162.000
1680 x 1050	1680 x 1050_60	59.954	65.29	146.25
1920 x 1080@60HZ	1920 x 1080_60 (CEA-861)	60	67.5	148.5
2560 x 1440@60HZ	2560 x 1440_60	59.951	88.787	241.5
3840 x 2160	3840 x 2160_30 (For 4K/2K model)	30	67.5	297
3840 x 2160	3840 x 2160_60 (For 4K/2K model)	60	135	594

Video

Timing	Resolution	Vertical frequency (Hz)	Horizontal frequency (KHz)	Dot Clock Frequency (MHz)
480i	720(1440) x 480	59.94	15.73	27
480p	720 x 480	59.94	31.47	27
576i	720(1440) x 576	50	15.63	27
576p	720 x 576	50	31.25	27
720/50p	1280 x 720	50	37.5	74.25
720/60p	1280 x 720	60	45.00	74.25
1080/24P	1920 x 1080	24	27	74.25
1080/25P	1920 x 1080	25	28.13	74.25
1080/30P	1920 x 1080	30	33.75	74.25
1080/50i	1920 x 1080	50	28.13	74.25
1080/60i	1920 x 1080	60	33.75	74.25
1080/50P	1920 x 1080	50	56.25	148.5
1080/60P	1920 x 1080	60	67.5	148.5
2160/24P	3840 x 2160	24	54	297
2160/25P	3840 x 2160	25	56.25	297
2160/30P	3840 x 2160	30	67.5	297
2160/50P	3840 x 2160	50	112.5	594
2160/60P	3840 x 2160	60	135	594

Note

As the timings available are limited to the EDID file and VGA graphic card, the user may not be able to select some of the above timings on the VGA display card.

3D mandatory

Timing	Frame packing	Top-and-bottom	Side-by-side (half)
1920 x 1080p @ 23.98 / 24Hz	V	V	
1920 x 1080i @ 59.94 / 60Hz			V
1920 x 1080i @ 50Hz			V
1280 x 720p @ 59.94 / 60Hz	V	V	

Audio format

- 1.4.1 Audio Format Code: LPCM
Channels: 2
Sampling Freq: 32 kHz, 44.1 kHz, 48 kHz
Sampling Size (bit): 24, 20, 16
- 1.4.2 Audio Format Code: Dolby Digital
Channels: 6
Sampling Freq: 32 kHz, 44.1 kHz, 48 kHz
Max Bit Rate: 640 kbps
- 1.4.3 Audio Format Code: Dolby Digital Plus
Channels: 8
Sampling Freq: 44.1 kHz, 48 kHz

USB-C input

PC

Resolution	Mode	Vertical frequency (Hz)	Horizontal frequency (KHz)	Dot Clock Frequency (MHz)
640 x 480	VGA_60	59.94	31.469	25.175
800 x 600	SVGA_60	60.317	37.879	40
1024 x 768	XGA_60	60.004	48.363	65
1280 x 720	1280 x 720_60	60	45	74.25
1280 x 768	1280 x 768_60	59.87	47.776	79.5
1280 x 800	SVGA_60	59.81	49.702	83.5
1280 x 1024	SXGA_60	60.02	63.981	108
1280 x 960	1280 x 960_60	60	60	108
1360 x 768	1360 x 768_60	60.015	47.712	85.5
1440 x 900	WXGA+_60	59.887	55.935	106.5
1440 x 1050	SXGA+_60	59.978	65.317	121.75
1680 x 1050	1680 x 1050_60	59.954	65.29	146.25
1920 x 1080@60HZ	1920 x 1080_60 (CEA-861)	60	67.5	148.5

Video

Timing	Resolution	Vertical frequency (Hz)	Horizontal frequency (KHz)	Dot Clock Frequency (MHz)
480i	720(1440) x 480	59.94	15.73	27
480p	720 x 480	59.94	31.47	27
576i	720(1440) x 576	50	15.63	27
576p	720 x 576	50	31.25	27
720/50p	1280 x 720	50	37.5	74.25
720/60p	1280 x 720	60	45.00	74.25
1080/24P	1920 x 1080	24	27	74.25
1080/25P	1920 x 1080	25	28.13	74.25
1080/30P	1920 x 1080	30	33.75	74.25
1080/50i	1920 x 1080	50	28.13	74.25
1080/60i	1920 x 1080	60	33.75	74.25
1080/50P	1920 x 1080	50	56.25	148.5
1080/60P	1920 x 1080	60	67.5	148.5
1440/60P	2560 x 1440	59.951	-	241.5
2160/60P	3840 x 2160	60	-	-
2160/50P	3840 x 2160	50	-	-
2160/30P	3840 x 2160	30	-	-
2160/25P	3840 x 2160	25	-	-
2160/24P	3840 x 2160	24	-	-

Note

As the timings available are limited to the EDID file and VGA graphic card, the user may not be able to select some of the above timings on the VGA display card.

Audio format (based on DP-Alt mode)

- Audio Format Code: LPCM
Channels: 2
Sampling Freq: 32 kHz, 44.1 kHz, 48 kHz
Sampling Size (bit): 24, 20, 16

Supported file formats

Video

MPEG-2 video decoder

- IISO/IEC 11172-2 MPEG-1 video format decoding
- ISO/IEC 13818-2 MPEG-2 video MP@HL and HD level
- Supports resolutions up to HDTV (1080p60, 1080i, 720p) and SDTV
- Supports dual stream decoding for 3D content
- Supports FHDp60 2x playback fast forwarding

MPEG-4 video decoder

- ISO/IEC 14496-2 MPEG-4 ASP video decoding up to HD level
- Supports resolutions up to HDTV (1080p@60fps)
- Supports FLV version1 video format decoding
- Supports dual stream decoding for 3D content

H.264 decoder

- ITU-T H.264, ISO/IEC 14496-10 (Main and High profile up to level 5.2) video decoding
- Supports resolutions up to 3840x2160@60fps
- Supports bitrates up to 135Mbps
- Supports resolutions for all DVB, ATSC, HDTV, DVD, and VCD
- Supports SVAF 2ES (for Dual Decode)
- Supports MVC 3D decoding up to 1080p@60fps

VP8 decoder

- Supports VP8 decoder
- Supports resolutions up to 1920x1080@60fps
- Supports bitrates up to a maximum of 50Mbps

VP9 decoder

- Supports VP9 decoder
- Supports 4:2:0 subsampling and 8bit/10bit color depth
- Supports a maximum resolution and frame rate of 3840x2160@60fps
- Supports bitrates up to a maximum of 100Mbps

AV1 Video decoder

- Supports AV1 video decoding
- Supports level 5.1 Main profile
- Supports 8-bit/10-bit color depth
- Supports resolutions up to 3840x2160@60fps
- Supports bitrates up to a maximum of 100Mbps

HEVC (H.265) decoder

- Supports HEVC/H.265 video decoding
- Supports Main/Main-10 profile, Scalable Main/Scalable Main-10 profile, level 5.1, and high tier
- Supports 8-bit/10-bit color depth
- Supports resolutions up to 3840x2160@60fps
- Supports bitrates up to a maximum of 100Mbps

Hardware JPEG decoder

- Supports resolutions up to 1920x1080@30fps and 1280x720@60fps
- Supports 422/411/420/444/422T formats
- Supports 1/2x1/2, 1/4x1/4, 1/8x1/8 scaling down ratios
- Supports both color and grayscale pictures
- Supports sequential mode and single scan
- Supports programmable Region of Interest (ROI)
- Following the file header scan, the hardware decoder fully handles the decode process

Audio

Supported digital audio formats:

- MPEG-1
- MPEG-2 (Layer I/II)
- MP3
- AAC-LC
- HE-AAC
- WMA
- WMA9 Pro



BenQ.com

© 2024 BenQ Corporation.
All rights reserved. Rights of modification reserved.