

## WPNET series

### WPNET4KV – WPNET8K -WPNETEX

REMOTE CONTROLERS AND INTERFACES

*Digital wall control*



## USER MANUAL

# INDEX

<b>HARDWARE.....</b>	<b>4-39</b>
<b>1 IMPORTANT REMARK .....</b>	<b>4</b>
<b>2 IMPORTANT SAFETY INSTRUCTIONS.....</b>	<b>4</b>
<b>3 IMPORTANT NOTE .....</b>	<b>6</b>
<b>4 INTRODUCTION.....</b>	<b>7</b>
4.1 Main features.....	7
<b>5 INSTALLATION .....</b>	<b>8</b>
5.1 Installation of a single WPNET4KV, WPNET8K or WPNETEX unit, on surface or flush:.....	8
5.2 Installation of a pair of adjacent WPNET4KV and WPNET8K panels, on surface or flush:.....	8
5.3 Installing an External Power Supply .....	9
<b>6 UNIT MANAGEMENT in standard or individual mode .....</b>	<b>10</b>
6.1 Unit WPNET4KV management.....	10
6.2 Unit WPNET8K management.....	14
6.3 Unit WPNET12KV management .....	17
6.4 Unit WPNETEX management.....	18
6.4.1 Preset selection.....	20
6.4.2 Selecting Sources.....	22
6.4.3 Equalization settings .....	24
6.4.4 Volume setting / MUTE .....	25
6.5 Units WPNET4KV or WPNET12KV operation in MULTI MODE .....	26
<b>7 NOTES: .....</b>	<b>32</b>
<b>8 FRONT PANEL.....</b>	<b>32</b>
8.1 WPNET4K / EX .....	32
8.2 WPNET8K .....	32
<b>9 REAR PANEL.....</b>	<b>33</b>

<b>10</b>	<b>BLOCK DIAGRAM</b> .....	<b>34</b>
	10.1 WPNET4KV / EX .....	34
	10.2 WPNET8K .....	34
<b>11</b>	<b>TECHNICAL FEATURES</b> .....	<b>35</b>
	11.1 WPNET4KV / EX .....	35
	11.2 WPNET8K .....	35
<b>12</b>	<b>ASSEMBLY DIAGRAM</b> .....	<b>36</b>
	12.1 WPNET4KV .....	36
	12.2 WPNET8K .....	37
	12.3 WPNETEX .....	38
<b>13</b>	<b>PACKAGE CONTENTS</b> .....	<b>39</b>

## COMPATIBILITIES.....40-63

<b>14</b>	<b>COMPATIBILITIES INTRODUCTION</b> .....	<b>41</b>
<b>15</b>	<b>RETRO-COMPATIBILITY &amp; CONTROL TABLE</b> .....	<b>42</b>
<b>16</b>	<b>WPNET “R” firmware upgrade</b> .....	<b>43</b>
<b>17</b>	<b>WPNET4KVR-WPNET8KR-WPNET12KVR &amp; MIMO88 series</b> .....	<b>45</b>
	17.1 WPNET4KVR / WPNET12KVR configuration .....	46
	17.2 WPNET4KVR / WPNET12KVR & MIMO series matrix as a host.....	47
	17.3 WPNET8KR & MIMO series matrix as a host .....	53
<b>18</b>	<b>WPNET4KVR-WPNET8KR-WPNET12KVR &amp; NXA series</b> .....	<b>55</b>
	18.1 WPNET4KVR / WPNET12KVR configuration .....	57
	18.2 WPNET4KVR / WPNET12KVR & NXA series unit as a host.....	58
	18.3 WPNET8KR & NXA series unit as a host.....	62
<b>19</b>	<b>Q&amp;A and GENERAL CONSIDERATIONS</b> .....	<b>63</b>

## 1 IMPORTANT REMARK



WARNING: SHOCK HAZARD - DO NOT OPEN  
AVIS: RISQUE DE CHOC ÉLECTRIQUE - NE PAS OUVRIR



The lightning flash with arrowhead symbol, within an equilateral triangle, is intended to alert the user to the presence of uninsulated “dangerous voltage” within the product’s enclosure that may be of sufficient magnitude to constitute a risk of electric shock to persons.



The exclamation point within an equilateral triangle is intended to alert the user to the presence of important operating and maintenance (servicing) instructions in the literature accompanying the appliance.

**WARNING (If applicable):** The terminals marked with symbol of “” may be of sufficient magnitude to constitute a risk of electric shock. The external wiring connected to the terminals requires installation by an instructed person or the use of ready-made leads or cords.

**WARNING:** To prevent fire or shock hazard, do not expose this equipment to rain or moisture.

**WARNING:** An apparatus with Class I construction shall be connected to a mains socket-outlet with a protective earthing connection.

## 2 IMPORTANT SAFETY INSTRUCTIONS

1. Read these instructions.
2. Keep these instructions.
3. Heed all warnings.
4. Follow all instructions.
5. Do not use this apparatus near water.
6. Clean only with dry cloth.
7. Do not block any ventilation openings. Install in accordance with the manufacturer’s instructions.
8. Do not install near any heat sources such as radiators, heat registers, stoves, or other apparatus (including amplifiers) that produce heat.

9. Do not defeat the safety purpose of the polarized or grounding type plug. A polarized plug has two blades with one wider than the other. A grounding type plug has two blades and a third grounding prong. The wide blade or the third prong are provided for your safety. If the provided plug does not fit into your outlet, consult an electrician for replacement of the obsolete outlet.
10. Protect the power cord from being walked on or pinched particularly at the plugs, convenience receptacles, and at the point where they exit from the apparatus.
11. Only use attachments/accessories specified by the manufacturer.
12. Unplug the apparatus during lightning sorts or when unused for long periods of time.
13. Refer all servicing to qualified personnel. Servicing is required when the apparatus has been damaged in any way, such as power supply cord or plug is damaged, liquid has been spilled or objects have fallen into the apparatus, the apparatus has been exposed to rain or moisture, does not operate normally, or has been dropped.
14. Disconnecting from mains: Switching off the POWER switch all the functions and light indicators of the amplifier will be stopped, but fully disconnecting the device from mains is done unplugging the power cord from the mains input socket. For this reason, it always shall remain readily operable.
15. Equipment is connected to a socket-outlet with earthing connection by means of a power cord.
16. The marking information is located at the bottom of apparatus.
17. The apparatus shall not be exposed to dripping or splashing and that no objects filled with liquids, such as vases, shall be placed on apparatus.

**NOTE:** *This equipment has been tested and found to comply with the limits for a Class A digital device, pursuant to part 15 of the FCC Rules. These limits are designed to provide reasonable protection against harmful interference when the equipment is operated in a commercial environment. This equipment generates, uses, and can radiate radio frequency energy and, if not installed and used in accordance with the instruction manual, may cause harmful interference to radio communications. Operation of this equipment in a residential area is likely to cause harmful interference in which case the user will be required to correct the interference at his own expense.*



**WARNING:** This product must not be discarded, under any circumstance, as unsorted urban waste. Take to the nearest electrical and electronic waste treatment centre.

**NEEC AUDIO BARCELONA, S.L.** accepts no liability for any damage that may be caused to people, animal or objects due to failure to comply with the warnings above.

### 3 IMPORTANT NOTE

Thank you for choosing our **digital wall control WPNET series**.

It is **VERY IMPORTANT** to carefully read this manual and to fully understand its contents before any connection in order to maximize your use and get the best performance from this equipment.

To ensure optimal operation of this device, we strongly recommend that its maintenance be carried out by our authorised Technical Services.

**All ECLER products are covered by warranty**, please refer to [www.ecler.com](http://www.ecler.com) or the warranty card included with this product for the period of validity and conditions.

The schemes and diagrams shown in the manual correspond to the models compatible with round installation box, available from products with serial numbers higher than those specified below. (\*):

Model	Serial number
WPNET4KV	266010001
WPNET8K	266020001
WPNETEX	266030001

(\* **Note:** The operation and characteristics of the WPNET panels compatible with a round case are identical to those existing in their previous versions, and which were compatible only with square boxes.

## 4 INTRODUCTION

WPNET4KV, WPNET8K and WPNETEX are digital wall controls, MIMO4040DN compatible, configurable through the EclerNet Manager application (\*).

They allow remote control functions over MIMO4040DN, such as audio source selection, volume adjustment, preset selection, etc.

(\*) Refer to the EclerNet Manager Application user manual at [www.ecler.com](http://www.ecler.com) for more information. The EclerNet Manager application is available for download at [www.ecler.com](http://www.ecler.com).

### 4.1 Main features

- Single European electrical box format, compatible with flush and surface installation (surface box supplied as standard)
- Compatible with circular base installation box, with diameter  $\geq 60$  mm, from products with serial number equal to or greater than those specified in the previous chapter
- Power over Ethernet (PoE) or optional external power supply, WP24-PSU model
- Ethernet communication interface, RJ45 connector
- 128x128 pixels LCD display
- Digital rotary control (encoder) + 4 programmable keys: 4KV and EX models
- 8 programmable keys: model 8K
- MIMO4040DN matrix remote control functions: audio source selection, preset selection, volume / MUTE adjustment, equalization settings, etc. (depending on models, refer to this manual and the EclerNet Manager application manual at [www.ecler.com](http://www.ecler.com))

## 5 INSTALLATION

The installation of the WPNET4KV, WPNET8K or WPNETEX units comprises the following steps, depending on the desired type of installation.

### 5.1 Installation of a single WPNET4KV, WPNET8K or WPNETEX unit, on surface or flush:

1. Remove the trim frame and front panel cover, held in place by magnets. You can use the magnet provided as a tool, by making contact in the upper right corner of the cover and gently pulling on it.
2. Connect the RJ-45 connector on the CAT5 or higher cable that will connect the unit to the local installation network. If necessary - see note below - connect external power.
3. Screw the device to the surface box or flush box.
4. Replace the frame and front panel and secure the rotary encoder knob.

**Note:** It is possible to use an adjacent pair of panels, consisting of a 4KV unit and an 8K unit, becoming a new single panel of greater dimensions and number of available controls for programming purposes and remote control possibilities, model [WPNET12KV](#). A double WPa2FMBOX box is required to flush both devices together, or a double WPa2SMBOX box for surface mounting. Both, the WPa2FMBOX and WPa2SMBOX are sold separately.

### 5.2 Installation of a pair of adjacent WPNET4KV and WPNET8K panels, on surface or flush:

1. Remove frames and front panel covers from both devices (WPNET4KV and WPNET8K), held in place by magnets. You can use the magnet provided as a tool, by making contact in the upper right corner of the cover and gently pulling on it.
2. Interconnect with the two hoses (supplied as standard with the 8K unit) the following point to point connectors between the two devices:
  - J102 (3-wire hose)
  - J107 (2-wire hose)
3. Connect the RJ-45 connector of the CAT5 cable or higher that will connect the unit to the local network of the installation to the WPNET4KV unit, which will act as the master unit of the two panels. Do not connect another CAT5 cable to the WPNET8K unit. If necessary - see note below - connect external power supply.
4. Screw the devices to the double surface box or flush box.
5. Mount the WPa2SMBOX or WPa2FMBOX double frame.
6. Replace the front panels and secure the knob of the rotary encoder..



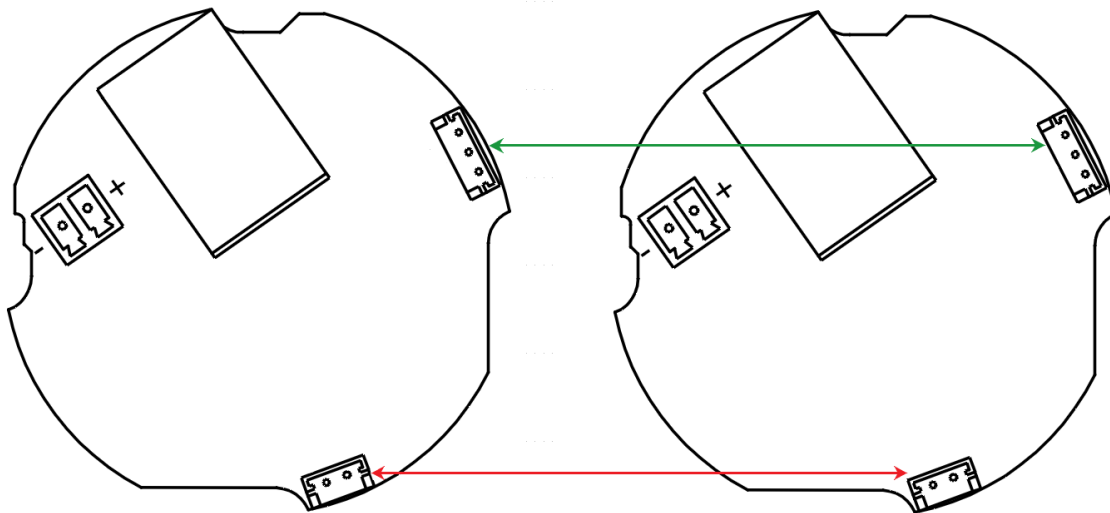

WPNET4KV + WPNET8K connection diagram = WPNET12KV  
(rear view of printed circuit boards)

### 5.3 Installing an External Power Supply

In case of not having a PoE type power received in the control panel directly from the connection port of the network switch to which it is connected, it is possible to power the panel through an optional external power supply, model WP24-PSU:

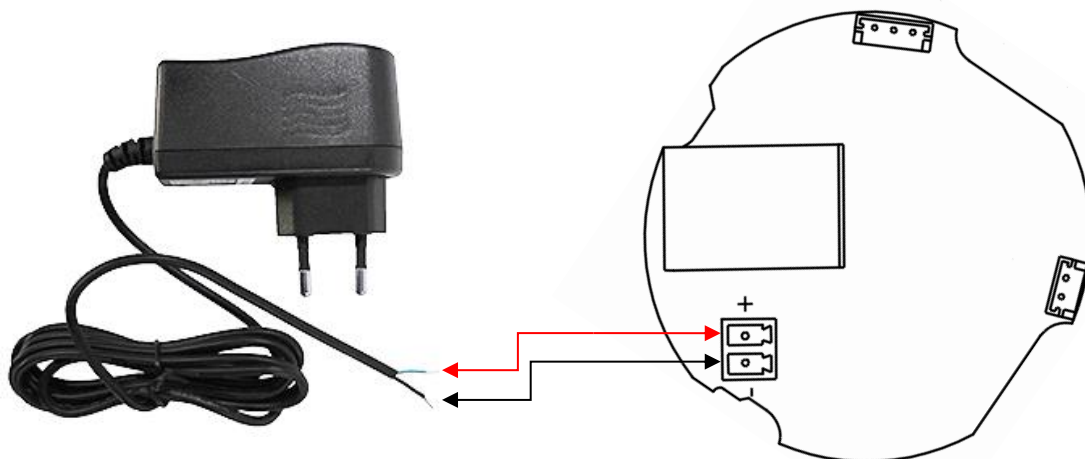

External power supply connection (rear view of the printed circuit board)

**Note:** if the external power supply WP24-PSU is used, it will be necessary to cut the cable, since the connection to the panels is made by bare cable, as shown in the previous diagram.

## 6 UNIT MANAGEMENT in standard or individual mode

### 6.1 Unit WPNET4KV management

**Note:** This section deals with the operation of a WPNET4KV unit in standard or individual mode, being able to take control of a zone of the installation. It is also possible to use it in “MULTI” mode, being able to take control of more than one zone. Please, refer to the section [Unit WPNET4KV or 12KV operation in MULTI MODE](#) for more information.

WPNET4KV has the following possible remote control functions on a MIMO4040DN unit, programmed from the EclerNet Manager application:

- Selecting sources or presets from a preset list in the EclerNet project
- Adjusting the volume of a preset signal in the EclerNet project
- MUTE ON/OFF of the same previous signal, preset in the EclerNet project

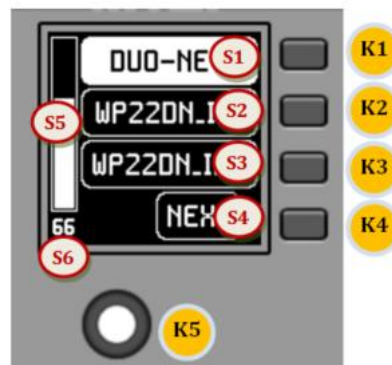

Front panel controls / on-screen information

In the previous image on the front panel, the available physical controls are:

- **K1 to K4:** keys directly associated with adjacent functions displayed on the screen
- **K5:** digital rotary control, or encoder, with rotary and pulsation functions

And the information fields shown on the screen are:

- **S1 to S4:** text fields 1 to 4
- **S5:** Adjusted volume indicator (signal level)
- **S6:** textual value of the adjusted volume (signal level)

Once the unit is connected to the network, powered (via PoE or optional external power supply) and correctly configured from the EclerNet Manager application, the main screen will display an image similar to the following:



Main screen, example

Text fields S1 to S3 show the first three options that can be selected using keys K1 to K3. Field S4 shows the text "NEXT", inviting you to press the K4 key to display more options suitable for selection. The total number of selectable options is defined by managing carousels of audio inputs (sound sources) or presets for each control panel, using the EclerNet Manager application.

If there are 4 or fewer selectable options, the screen will show them directly in fields S1 to S4, without adding the "NEXT" function as an option associated with the K4 key.

In the example above, which uses a carousel of audio sources as selectable options, we see the following information:

- **S1, option 1** (currently selected = shown in negative): MIMO4040DN audio input labeled **DUO-NET**. Selectable (=actionable) by pressing the key K1
- **S2, option 2**: MIMO4040DN audio input labeled **FM TUNER**. Selectable by pressing the K2 key
- **S3, option 3**: MIMO4040DN audio input labeled **ePLAYER1**. Selectable by pressing the K3 key
- **S4, option 4**: Move to the next screen of valid options by pressing the K4 key.
- **S5**, Vu-meter showing the currently set volume of the audio signal the remote panel is pointing at (this signal can be an output, an input, a matrix crossover point, or sending the currently selected source to the destination output).
- **S6**, value of the currently set volume of the audio signal to which the remote panel is pointing or the "MUTE" symbol if the audio signal is muted.

The following picture shows the selected FM TUNER input, and another volume adjustment value in the Vu-meter, in this case the sending value of this input (sound source) to the destination output (83).



When acting on the K5 rotary control, aiming at modifying the volume to which it points, a different screen is temporarily shown, returning a few seconds to the previous or main screen. Example:

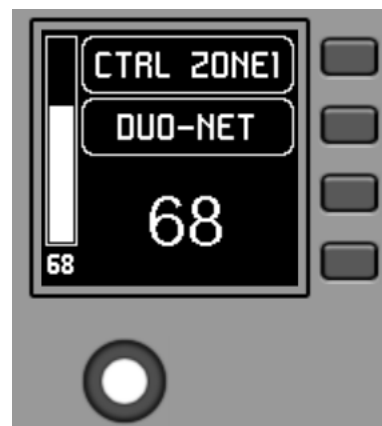

- **S1:** Name (label) assigned to the control panel, defined from the EclerNet Manager application. In the example "CTRL ZONE1".
- **S2:** option of the currently selected carousel. In the "DUO-NET" example
- **S5, S6:** volume value being adjusted by rotary control, displayed in real time, and matching the same numerical value displayed in larger characters in the lower middle section of the display (68 in the example above).

Pressing the rotary control activates the MUTE function, if enabled for triggering from the WPNET4KV unit:



If the volume control function is not enabled for the WPNET4KV unit, turning or pressing the rotary control will temporarily display such a screen, with the central flashing "--" symbols:



The long press (> 5 seconds) on the rotary control displays the configuration parameters of the unit: name, model, firmware version and Ethernet network connection parameters:



## 6.2 Unit WPNET8K management

WPNET8K has the following possible remote control functions on a MIMO4040DN unit, programmed from the EclerNet Manager application:

- Selecting sources or presets from a preset list in the EclerNet project

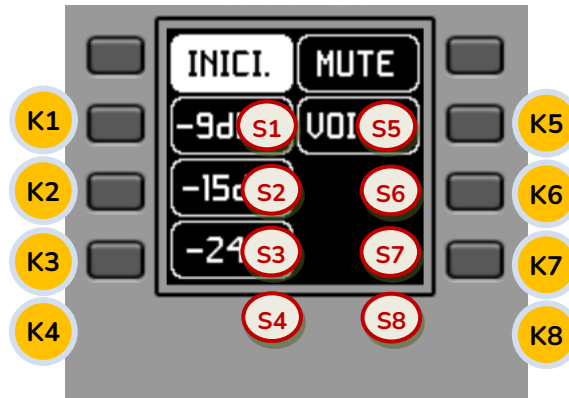

Front panel controls / on-screen information

In the previous image on the front panel, the available physical controls of this panel are:

- **K1 to K8:** keys directly associated with functions displayed on the screen

And the information fields on screen are:

- **S1 to S8:** text fields 1 to 8

Once the unit is connected to the network, powered (via PoE or optional external power supply) and correctly configured from the EclerNet Manager application, the main screen will display an image similar to the following:



Main screen, example

Text fields S1 to S7 show the first seven options that can be selected using keys K1 to K7. Field S8 shows the text "NEXT", inviting you to press the K8 key to display more options suitable for selection. The total number of selectable options is defined by managing carousels of audio inputs (sound sources) or presets for each control panel, using the EclerNet Manager application.

If there are 8 or fewer selectable options, the screen will show them directly in fields S1 to S8, without adding the "NEXT" function as an option associated with the K8 key.

In the example above, which uses a carousel of presets as selectable options, we see the following information:

- **S1**, option 1 (currently selected = shown in negative): Active preset, stored in the MIMO4040DN configuration and labelled **START**. The information on the screen in this case does not show all the characters of its label (name) in this general view, since sometimes they do not fit in the space reserved for the texts. In such cases, a dot is added to the end of the displayed text. Selectable (=actionable) by pressing the key K1
- **S2 to S7**, options 2 to 7: **presets** labelled “-9dBV”, “-15dBV”, “-24dBV”, “MUTE”, “VOICE”, “MEETING”. The information on the screen in some of these cases does not show all the characters of its label (name) in this general view, since sometimes they do not fit in the space reserved for the texts. In such cases, a dot is added to the end of the displayed text. Selectable (=actionable) by pressing the keys K1 to K7
- **S8**, option 8: Move to the next screen of valid options by pressing the K8 key.

By pressing one of the keys K1 to K7, the display will go on to show the extended text information, without making the relevant selection yet. The following example shows the display after pressing the K7 key once, indicating the extended S7 text information ("MEETING" instead of "MEETI."):



Pressing the same key a second time performs the selection action, showing in negative the new option (preset), already active (= preset activated):



In the previous example, pressing the K8 key activates the "NEXT" option, displaying the following screen of available options:



The long press (> 5 seconds) of any key, K1 to K8, shows the configuration parameters of the unit: name, model, firmware version and Ethernet network connection parameters:





### 6.3 Unit WPNET12KV management

It is possible to use an adjacent pair of panels, consisting of a WPNET4KV unit and an WPNET8K unit, **becoming a new single panel of greater dimensions and number of available controls for programming purposes and remote control possibilities, model WPNET12KV.**

Refer to the chapter [Installation of a pair of adjacent WPNET4KV and WPNET8K panels, on surface or flush](#), for more information on assembling such a pair.

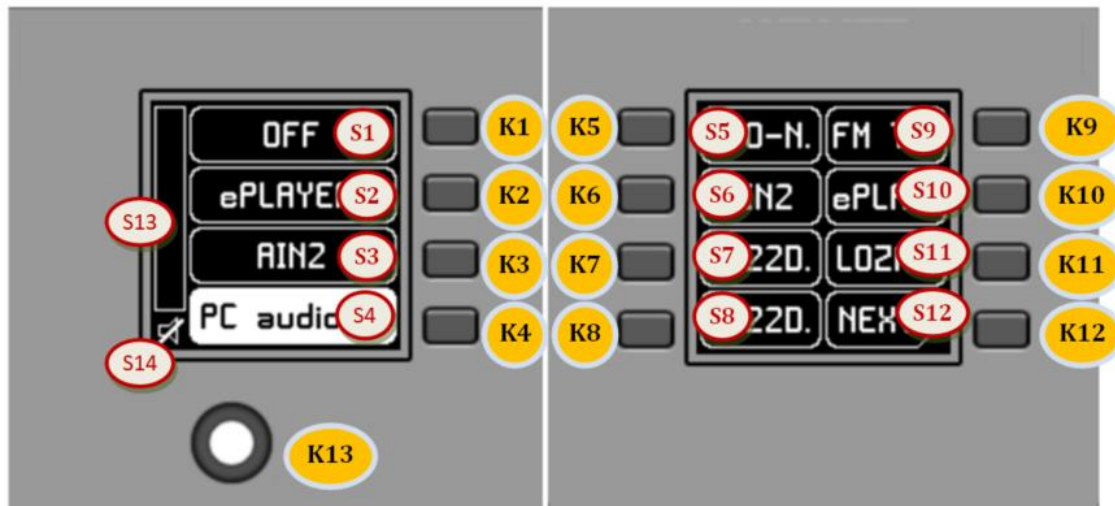

Front panel controls / on-screen information

The resulting panel, model WPNET12KV, has the rough appearance of the previous image.

WPNET12KV has the following possible remote control functions on a MIMO4040DN unit, programmed from the EclerNet Manager application:

- Selecting sources or presets from a preset list in the EclerNet project
- Adjusting the volume of a preset signal in the EclerNet project
- MUTE ON/OFF of the same previous signal, preset in the EclerNet project

In the previous image on the front panel, the available physical controls are:

- **K1 to K12**: keys directly associated with adjacent functions displayed on the screen
- **K13**: digital rotary control, or encoder, with rotary and pulsation functions

And the information fields shown on the screen are:

1. S1 to S12: text fields 1 to 12
2. S13: Adjusted volume indicator (signal level)
3. S14: textual value of the adjusted volume (signal level)

The possibilities of control and operation of the unit are identical to those described in the section [Unit WPNET4KV management](#) for the WPNET4KV model, in this case extending the direct selection keys and the selection options shown on the screen from 4 to 12.

#### 6.4 Unit WPNETEX management

WPNETEX, or WPNET "EXTENDED", is the model of the range of WPNET panels with the greatest possibility of control functions, some of them recommended for an advanced system user profile. All the possible remote control functions on a MIMO4040DN unit can be enabled or not for simultaneous use from the same WPNETEX unit, and programmed from the EclerNet Manager application:

- Selecting presets from a preset list in the EclerNet project
- Selecting sound sources from a preset list in the EclerNet project
- Adjusting the volume of a preset signal in the EclerNet project
- MUTE ON/OFF of the same previous signal, preset in the EclerNet project
- Tone control (equalizer) of up to three bands, or EQ filters 1 to 3 of an output (mono or stereo) of a MIMO4040DN unit, pre-configured in the EclerNet project

As it offers more control functions of different types, **the operation of this unit is not based on the activation of immediate selection options by directly pressing the keys assigned to them**, but on menus, which are accessible from these keys, and within which the selection is made by turning the rotary control and pressing to confirm the selection.

The text information shown corresponds to the functions enabled in the programming of the WPNETEX unit carried out in the EclerNet project. If, for example, the preset selection function is not enabled, this option will not appear as an available menu. Or if you enable a 2 cutoff tone control, only these - and not the 3 that exist at most - will appear as adjustable when accessing the equalization menu.

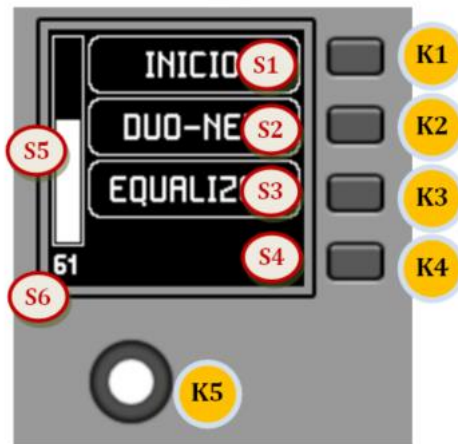

Front panel controls / on-screen information

In the previous image on the front panel, the available physical controls are:

- **K1 to K4:** keys associated with menu selection / adjacent option S1 to S4 displayed on screen
- **K5:** digital rotary control, or encoder, with rotary and pulsation functions

And the information fields shown on the screen are:

- **S1 to S4:** text fields 1 to 4
- **S5:** Adjusted volume indicator (signal level)
- **S6:** textual value of the adjusted volume (signal level)

Once the unit is connected to the network, powered (via PoE or optional external power supply) and correctly configured from the EclerNet Manager application, the main screen will display an image similar to the following:



Main screen, example

- **S1:** Preset active, in the previous example "START". Preset selection menu accessible via K1
- **S2:** selected sound source, in the previous example "DUO-NET". Source selection menu accessible via K2
- **S3:** text to access the equalisation menu, via K3

#### 6.4.1 Preset selection

The text field S1 shows the active preset, in the example above the preset labeled "START" on the MIMO4040DN unit. Pressing the K1 key takes you to the preset selection menu:



In this menu, S3 displays the active preset, while S2 flashes the options of the assigned carousel of available presets as you navigate through the K5 turn:

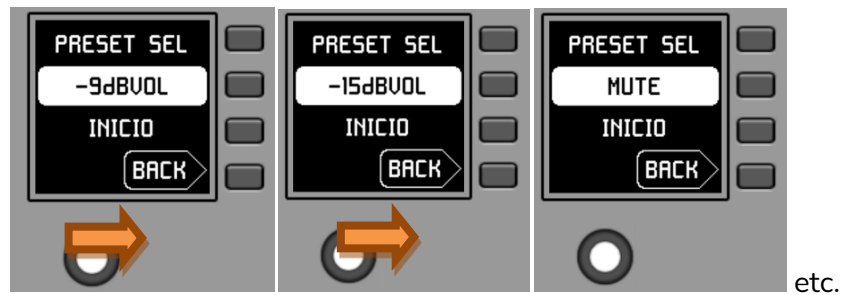

Pressing K5 confirms the loading action of the preset shown in the previous screen, in the following example the preset "MUTE", returning to the main screen with the information of the new active preset updated in S1:



A new press of K1 would give access to the preset selection menu with this new look (active preset = "MUTE"):



### 6.4.2 Selecting Sources

The text field S2 shows the active preset, in the example above the preset labeled "DUO-NET" on the MIMO4040DN unit:



From the main screen, pressing the K2 key accesses the source selection menu:

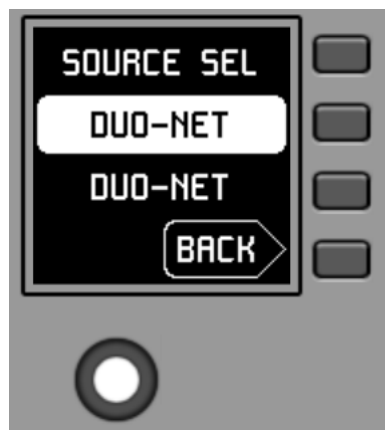

In this menu, S3 shows the selected source, while S2 flashes the options of the assigned carousel of available sources, as you navigate by turning K5:

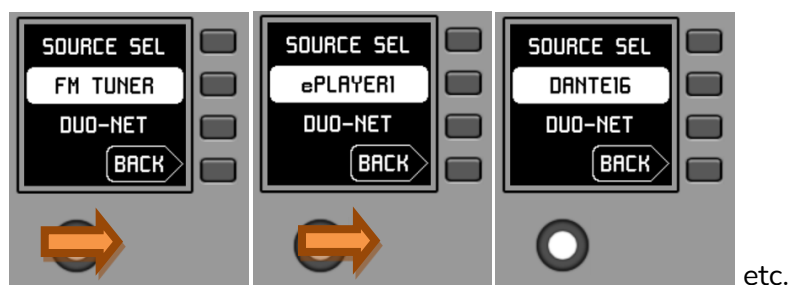

Pressing K5 confirms the source selection action shown in the previous screen, in the following example the source "DANTE16", returning to the main screen with the information of the new selected source updated in S1:



A new press of K2 would give access to the font selection menu with this new aspect (selected font = "DANTE16"):



### 6.4.3 Equalization settings

On the main screen, text field S3 shows the text accessing the equalization menu. Pressing K3 gives access to this menu:

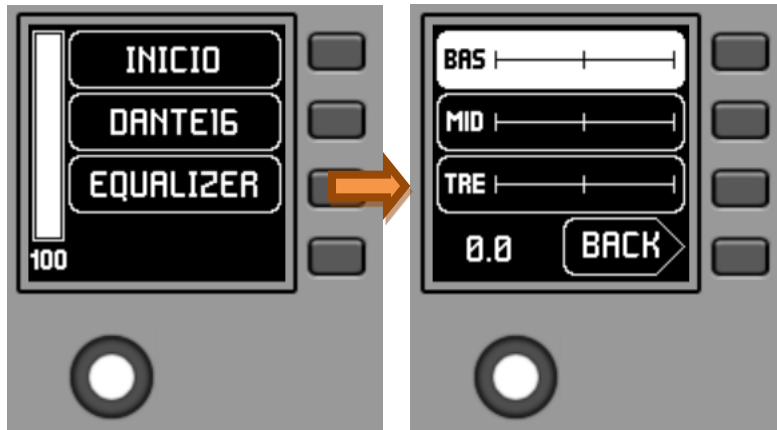

This new screen shows the equalization filters available for adjustment, with the names defined in the EclerNet project (3-character names, in the previous example BAS (BASS), MI (MID) and TRE (TREBLE)). Pressing keys K1 to K3 selects one of them, so that the rotation of K5 allows its gain adjustment (enhancement or attenuation). Example for the MID filter after pressing K2 and rotating K5:



Changes to these settings are in real time and do not require K5 to be pressed or any other action to confirm. However, a long press of K5 (>3 seconds) within this menu resets the EQ filters to 0 (flat equalization).

Pressing K4 forces the output from this menu to the main screen.



#### 6.4.4 Volume setting / MUTE

Like any other panel in the WPNET series, the volume control options, if enabled, operate from the main display by turning K5 (volume adjustment) and/or pressing K5 (MUTE control).

When acting on the rotary control K5, with the objective of modifying the volume to which the unit points, a different screen is temporarily shown, returning a few seconds to the previous or main screen. Example:

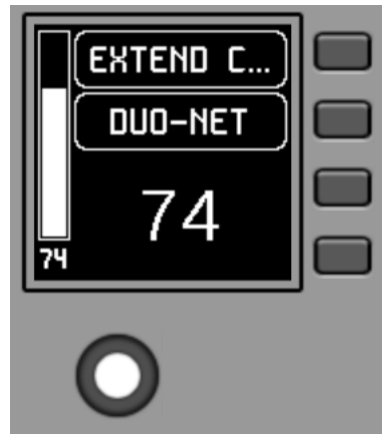

- **S1:** Name (label) assigned to the control panel, defined from the EclerNet Manager application. In the example "EXTENDED C..." (EXTENDED CONTROL)
- **S2:** option of the currently selected source carousel. In the "DUO-NET" example
- **S5, S6:** volume value being adjusted by rotary control, displayed in real time, and matching the same numerical value displayed in larger characters in the lower middle section of the display (74 in the example above).

Pressing the rotary control activates the MUTE function, if enabled for triggering from the WPNETEX unit:



If the volume control function is not enabled for the WPNETEX unit, turning or pressing the rotary control will temporarily display such a screen, with the central flashing “- -” symbols:



The long press (> 5 seconds) on the rotary control displays the configuration parameters of the unit: name, model, firmware version and Ethernet network connection parameters:



## 6.5 Units WPNET4KV or WPNET12KV operation in MULTI MODE

From EclerNet Manager it is possible to include in a project panels such as WPNET4KV and/or WPNET12KV the "MULTI" type. This type of panels are associated to a hardware unit WPNET4KV or WPNET12KV, respectively, which are programmed to take the role of different individual panels WPNET4KV or WPNET12KV included in the project. These individual panels can, in turn, have a one-to-one link with real WPNET4KV or WPNET12KV hardware units, or exist in the project only virtually.

In this way, by taking on the role of different individual panels, each with its specific programming, it is possible from a single hardware panel to act on different zones of a MIMO4040DN unit (panels with source selectors) and/or even opt to select different sets of presets (panels with preset selectors).

A MULTI panel, once programmed, will show on the screen the information of the individual panel from which it is taking the role:

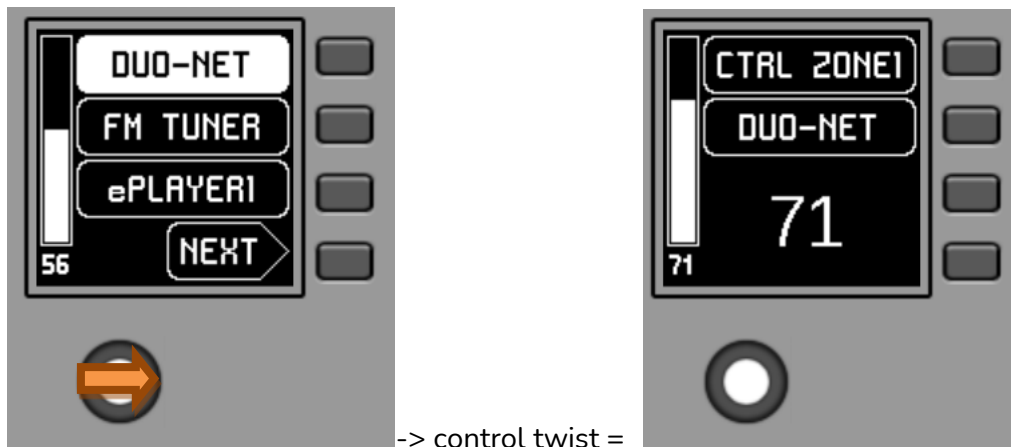

The image above shows how a control programmed as WPNET4KV MULTI is taking on the role of an individual WPNET4KV control called "CTRL ZONE1", so that it shows the carousel options and the rest of the carousel information.

A long press on the rotary control (>5 seconds) gives access to the role change menu of this MULTI type hardware panel:



In the previous example it can be seen that there are two possible individual panels as options for the MULTI panel to take its role: CTRL ZONE1 and CTRL ZONE2. By means of K1 and K2, in this case, it is possible to select one or the other. Example by selecting the individual panel CTRL ZONE2 (key K2):

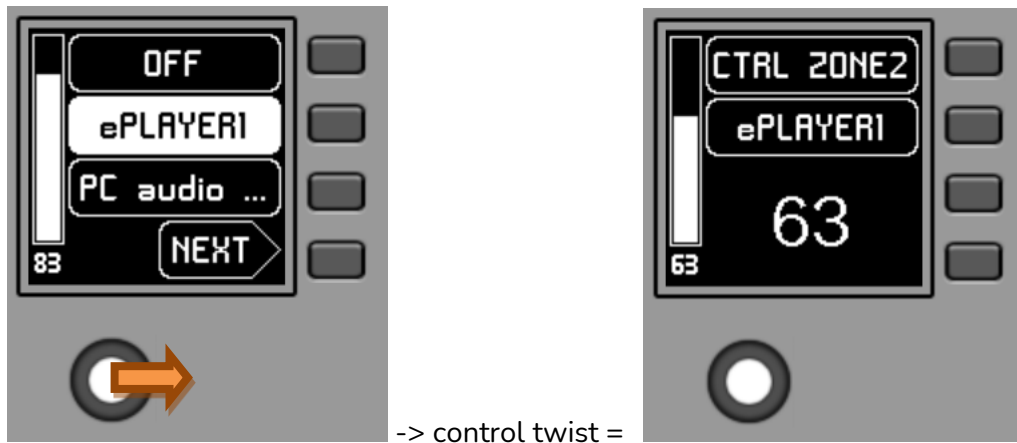

It can be seen in this case that the selection carousel options and the rest of the information of the individual panel WPNET4KV "CTRL ZONE2" are different from those of the previous panel "CTRL ZONE1".

From the EclerNet Manager application it is possible to define:

- Number of individual panels included in a project
- Specific programming of each of the above, and link or not to real panels hardware
- Number of panels WPNET4KV and/or WPNET12KV type MULTI
- Programming of the same: selection, from the list of individual panels type WPNET4KV and WPNET12KV previously defined, of which of them will be part of the list of options to take their role.

Once the unit is connected to the network, powered (via PoE or optional external power supply) and correctly configured from the EclerNet Manager application, the main screen will display an image similar to the following:



Main screen, example

Text fields S1 to S3 show the first three options that can be selected using keys K1 to K3. Field S4 shows the text "NEXT", inviting you to press the K4 key to display more options suitable for selection. The total number of selectable options is defined by managing carousels of audio inputs (sound sources) or presets for each control panel, using the EclerNet Manager application.

If there are 4 or fewer selectable options, the screen will show them directly in fields S1 to S4, without adding the "NEXT" function as an option associated with the K4 key.

In the example above, which uses a carousel of audio sources as selectable options, we see the following information:

- **S1, option 1** (currently selected = shown in negative): MIMO4040DN audio input labeled **DUO-NET**. Selectable (=actionable) by pressing the key K1
- **S2, option 2**: MIMO4040DN audio input labeled **FM TUNER**. Selectable by pressing the K2 key
- **S3, option 3**: MIMO4040DN audio input labeled **ePLAYER1**. Selectable by pressing the K3 key
- **S4, option 4**: Move to the next screen of valid options by pressing the K4 key.
- **S5**, Vu-meter showing the currently set volume of the audio signal the remote panel is pointing at (this signal can be an output, an input, a matrix crossover point, or sending the currently selected source to the destination output).
- **S6**, value of the currently set volume of the audio signal to which the remote panel is pointing, or the "MUTE" symbol if the audio signal is muted.

The following picture shows the selected FM TUNER input, and another volume adjustment value in the Vu-meter, in this case the sending value of this input (sound source) to the destination output (83).



When acting on the K5 rotary control, aiming at modifying the volume to which it points, a different screen is temporarily shown, returning a few seconds to the previous or main screen. Example:

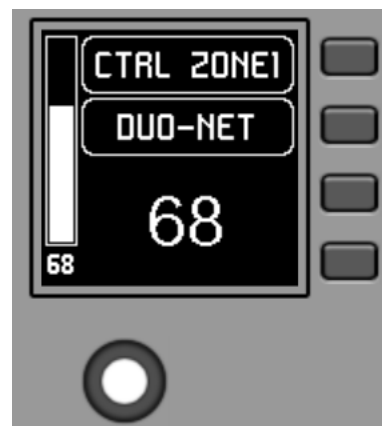

- **S1:** Name (label) assigned to the control panel, defined from the EclerNet Manager application. In the example "CTRL ZONE1".
- **S2:** option of the currently selected carousel. In the "DUO-NET" example
- **S5, S6:** volume value being adjusted by rotary control, displayed in real time, and matching the same numerical value displayed in larger characters in the lower middle section of the display (68 in the example above).

Pressing the rotary control activates the MUTE function, if enabled for triggering from the WPNET4KV unit:



If the volume control function is not enabled for the WPNET4KV unit, turning or pressing the rotary control will temporarily display such a screen, with the central flashing "--" symbols:



The long press (> 5 seconds) on the rotary control displays the configuration parameters of the unit: name, model, firmware version and Ethernet network connection parameters:



## 7 NOTES:

Check that all MIMO4040DN, WPNET, etc. units in a project are working with the latest firmware versions available.

At [www.ecler.com](http://www.ecler.com) an EclerNet software firmware package is always available, including the latest official versions of EclerNet Manager firmware and software.

## 8 FRONT PANEL

### 8.1 WPNET4K / EX

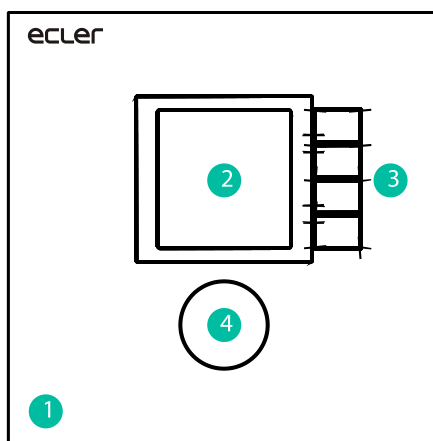

1. Front panel cover
2. LCD screen
3. Selection keys (K1 to K4)
4. Rotary encoder (K5)

### 8.2 WPNET8K

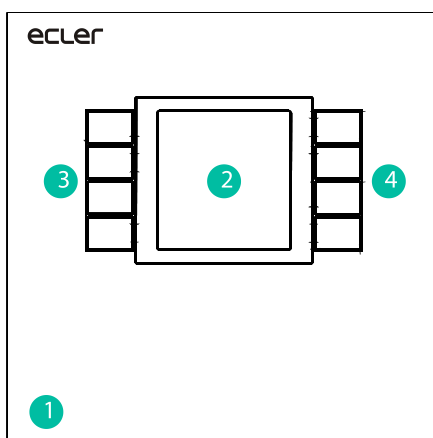

1. Front panel cover
2. LCD screen
3. Selection keys (K1 to K4)
4. Selection keys (K5 to K8)



## 9 REAR PANEL

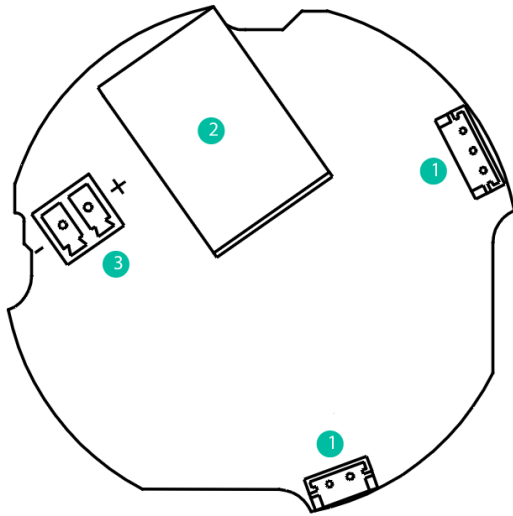

1. J102, J107: WPNET4KV and WPNET 8K panels interconnection connectors
2. J104: RJ-45 Connector
3. J106: External power 24VDC connector

## 10 BLOCK DIAGRAM

### 10.1 WPNET4KV / EX

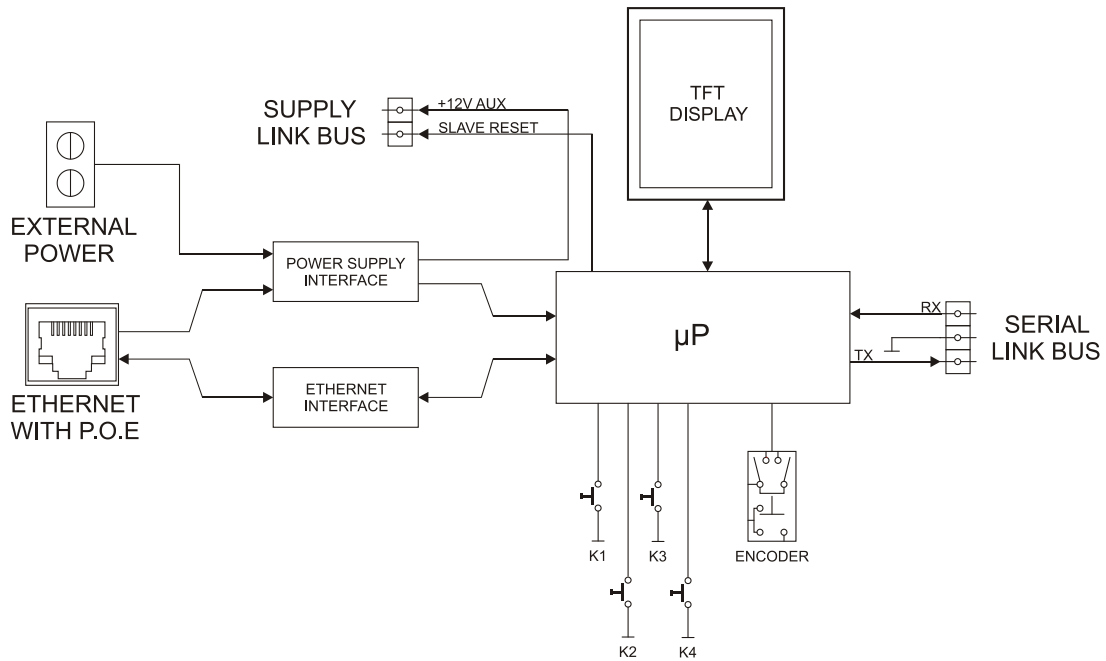

### 10.2 WPNET8K

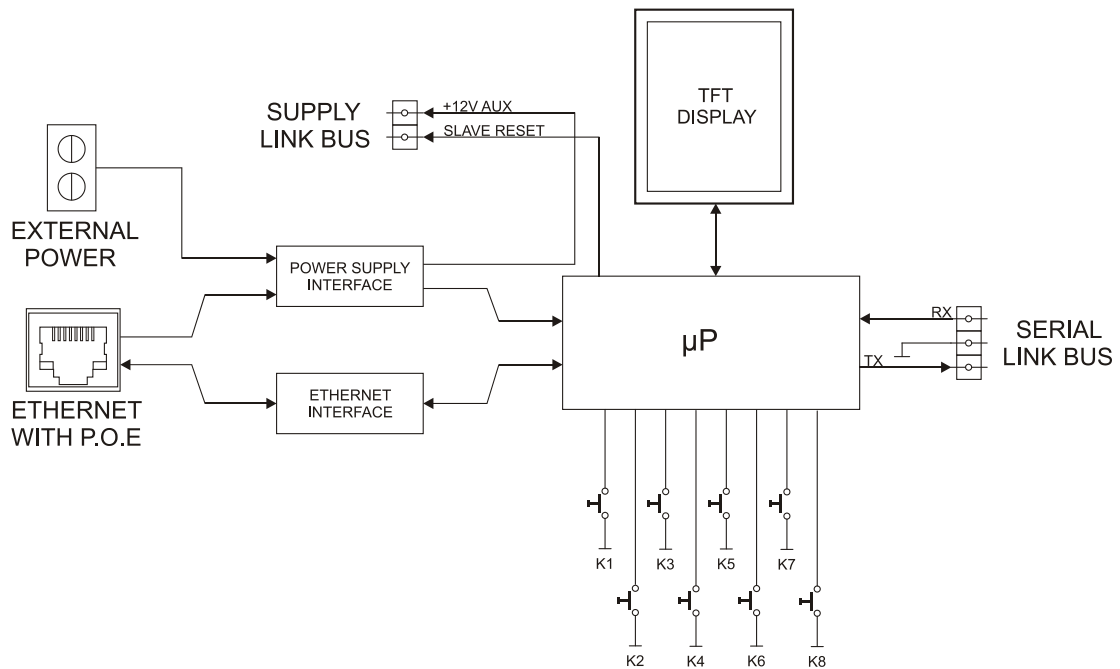

## 11 TECHNICAL FEATURES

### 11.1 WPNET4KV / EX

DIGITAL CHARACTERISTICS:	
Control keys	Encoder, 4 CONTROL keys
Indicators	LCD Display – 128x128 Pixels
Communication Standard	Ethernet
SUPPLY CHARACTERISTICS:	
Poe Power supply	PoE: class 0 802.3af Poe PD compliant
External Power supply	12 - 24VDC
Maximum Power Consumption	From PoE: 35mA / 1.6W From Ext Power: 1.5W
MISCELLANEOUS:	
Connector	RJ45 Remote port
Finished colour	White (RAL 9016)
Dimensions	W 86mm x D 30mm x H 86mm
Weight	120gr
Cable Quality	CAT-5e or better

### 11.2 WPNET8K

DIGITAL CHARACTERISTICS:	
Control keys	8 CONTROL keys
Indicators	LCD Display – 128x128 Pixels
Communication Standard	Ethernet
SUPPLY CHARACTERISTICS:	
Poe Power supply	PoE: class 0 802.3af Poe PD compliant
External Power supply	12 - 24VDC
Maximum Power Consumption	From PoE: 35mA / 1.6W From Ext Power: 1.5W (WP24-PSU power supply model)
MISCELLANEOUS:	
Connector	RJ45 Remote port
Finished colour	White (RAL 9016)
Dimensions	W 86mm x D 30mm x H 86mm Compatible with round electrical box ( $\varnothing \geq 60$ mm), starting from serial n° 266020001 products
Weight	120gr
Cable Quality	CAT-5e or better
Includes accessories	Two cables are included to connect to WPNET4KV and create WPNET12KV

## 12 ASSEMBLY DIAGRAM

### 12.1 WPNET4KV

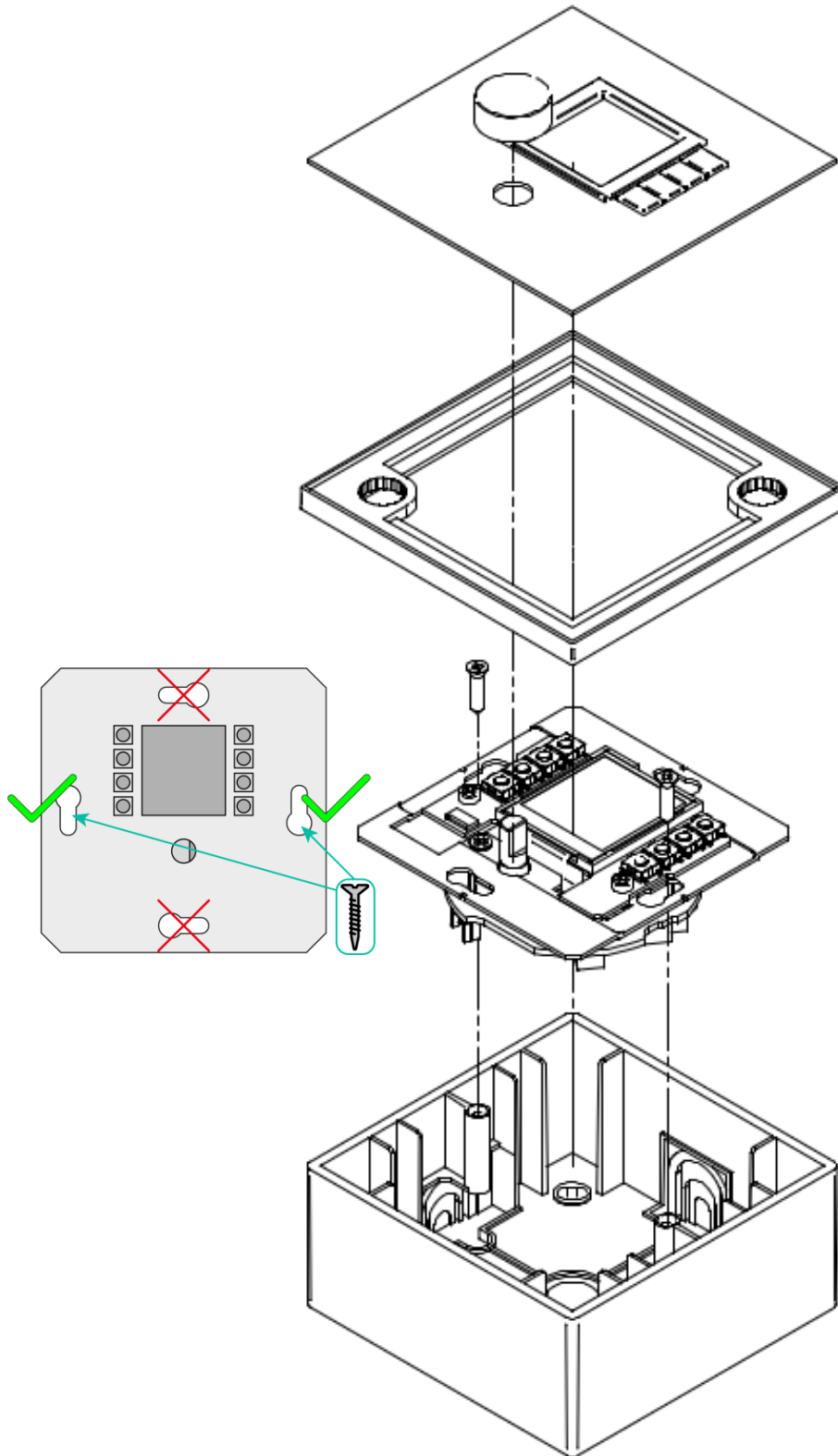

12.2 WPNET8K

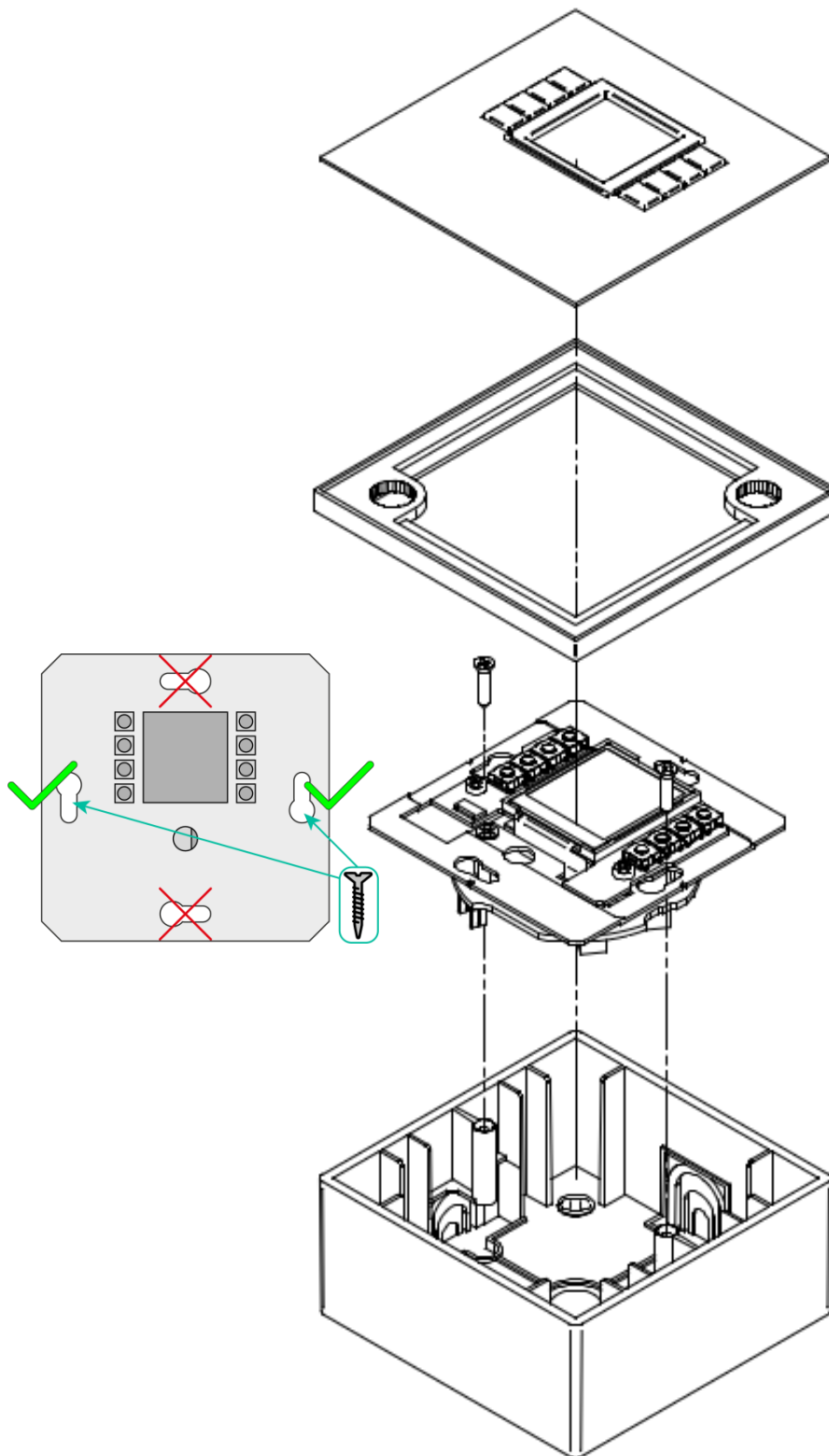

12.3 WPNETEX

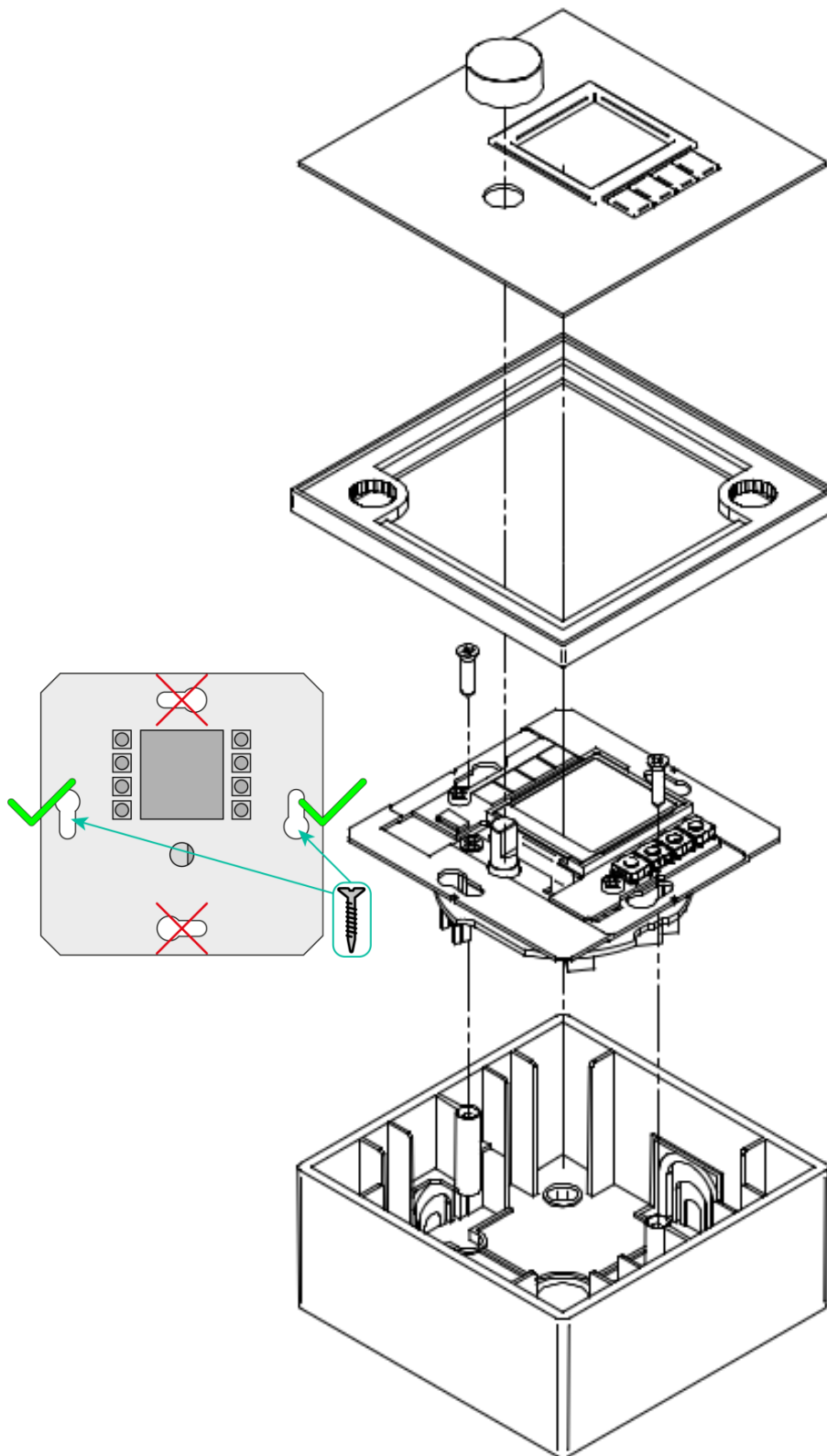

### 13 PACKAGE CONTENTS

- One WPNET4KV, WPNET8K or WPNETEX model unit
- Frame for mounting on single-mechanism systems
- Screws for fixing to surface or flush box
- Magnet for cover removal
- Surface box
- Quick User Guide
- Warranty Card
- **Only in model WPNET8K:** Hoses for connection to WPNET4KV, converting

# WPNET4KV & WPNET8K

## *Compatibilities*



### COMPATIBILITY WITH:

- MIMO88
- MIMO88SG
- MIMO1212SG
- NXA series

## USER MANUAL



## 14 COMPATIBILITIES INTRODUCTION

WPNET4KV, WPNET8K and WPNETEX are digital wall panels designed to obtain their maximum performance when working together with the MIMO4040DN Dante digital matrix as the host device (taking remote control of some of its working parameters).

However, a new firmware version (JUNE 2019 onwards) **for the WPNET4KV and WPNET8K models** (**attention:** but **not for the WPNETEX**) has been developed to make them as well compatible with many other EclerNet hardware devices: MIMO88, MIMO88SG, MIMO1212SG digital matrices and NXA series Digital Audio Managers.

The new firmware version is identified, within the usual EclerNet software and firmware pack available from [www.ecler.com](http://www.ecler.com), with an “R” suffix, **R** standing for “**R**etro-compatible”. Examples:

4. **firmware\_WPNET\_R\_v1\_00r2.bin** : this is a firmware file for the WPNET4K and WPNET8K, making them compatible with a MIMO88, MIMO88SG, MIMO1212SG or NXA series unit as the host device
5. **firmware\_WPNET\_v1\_02r7.bin** : this is a firmware file for WPNET series (full series, including WPNET4KV, WPNET8K and WPNETEX), making them compatible just with MIMO4040DN as the host device

**Important note:** a WPNET4KV or WPNET8K can carry just one of the above 2 firmware possibilities:

6. the one that works with MIMO4040DN (but not with MIMO88, MIMO88SG, MIMO1212SG and NXA series)
- or**
7. the one “retro-compatible” that works with MIMO88, MIMO88SG, MIMO1212SG or NXA series (but not with MIMO4040DN).

WPNET4KV and WPNET8K hardware units can be upgraded with any of these two firmware profiles, at any time.

**Note:** It is possible to use an adjacent pair of panels, consisting of a WPNET4KV unit and a WPNET8K unit, **becoming a new single panel of greater dimensions and number of available controls, model WPNET12KV**. A double WPa2FMBOX box is required to flush mount both devices together, or a double WPa2SMBOX box for surface mounting. Both, the WPa2FMBOX and WPa2SMBOX are sold separately.

**Note:** when a **WPNET4KV and a WPNET8K**, both upgraded with the same “retro compatible” firmware version, are merged to become a **WPNET12KVR** unit, this one can be used as well to control MIMO88, MIMO88SG, MIMO1212SG and NXA series hardware devices.

See the [WPNET4KV, WPNET8K and WPNETEX user manual](#) for more details about getting a WPNET12KV device from two isolated WPNET4KV and WPNET8K units.

## 15 RETRO-COMPATIBILITY & CONTROL TABLE

These are the control options that WPNET4KV, WPNET8K and WPNET12KV models can have over EclerNet hardware host devices in retro-compatible mode, and the maximum of WP units that can be used in each case, simultaneously connected to a single host device:

Hardware HOST device	WPNET model	WPNET4KV	WPNET8K	WPNET12KV
MIMO88 ** / MIMO88SG	Maximum number of units *	<b>8</b> (combined WPNET4KV and/or WPNET8K and/or WPNET12KV)		
	Control options	<ul style="list-style-type: none"> <li>•Preset or source selection</li> <li>•Volume control</li> <li>•MUTE control</li> </ul>	<ul style="list-style-type: none"> <li>•Preset or source selection</li> </ul>	<ul style="list-style-type: none"> <li>•Preset or source selection</li> <li>•Volume control</li> <li>•MUTE control</li> </ul>
MIMO88 CONFERENCE ** / MIMO88SG CONFERENCE	Maximum number of units *	<b>6</b> (combined WPNET4KV and/or WPNET8K and/or WPNET12KV)		
	Control options	<ul style="list-style-type: none"> <li>•Preset or source selection</li> <li>•Volume control</li> <li>•MUTE control</li> </ul>	<ul style="list-style-type: none"> <li>•Preset or source selection</li> </ul>	<ul style="list-style-type: none"> <li>•Preset or source selection</li> <li>•Volume control</li> <li>•MUTE control</li> </ul>
MIMO1212	Maximum number of units *	<b>12</b> (combined WPNET4KV and/or WPNET8K and/or WPNET12KV)		
	Control options	<ul style="list-style-type: none"> <li>•Preset or source selection</li> <li>•Volume control</li> <li>•MUTE control</li> </ul>	<ul style="list-style-type: none"> <li>•Preset or source selection</li> </ul>	<ul style="list-style-type: none"> <li>•Preset or source selection</li> <li>•Volume control</li> <li>•MUTE control</li> </ul>
MIMO1212SG CONFERENCE	Maximum number of units *	<b>10</b> (combined WPNET4KV and/or WPNET8K and/or WPNET12KV)		
	Control options	<ul style="list-style-type: none"> <li>•Preset or source selection</li> <li>•Volume control</li> <li>•MUTE control</li> </ul>	<ul style="list-style-type: none"> <li>•Preset or source selection</li> </ul>	<ul style="list-style-type: none"> <li>•Preset or source selection</li> <li>•Volume control</li> <li>•MUTE control</li> </ul>
NXA4-80 NXA4-200 NXA4-400 NXA6-80 NXA6-200	Maximum number of units *	<b>8</b> (combined WPNET4KV and/or WPNET8K and/or WPNET12KV)		
	Control options	<ul style="list-style-type: none"> <li>•Source selection</li> <li>•Volume control</li> </ul>	<ul style="list-style-type: none"> <li>•Source selection</li> </ul>	<ul style="list-style-type: none"> <li>•Source selection</li> <li>•Volume control</li> </ul>

\* **Note:** regarding the Maximum number of WPNET units:

Each WPNET unit establishes and “spends” one TP-NET client connection with the host hardware (being it a MIMO or NXA series unit) to take the control of some of its parameters. The above figures regarding maximum number of WPNET units (8, 6, 12, 10 and 8), for each kind of host device, really indicate the maximum number of TP-NET client connections it can support. In other words: if an external, third-party device (like Crestron®, Extron®, Neets®, AMX®, etc. control units) has to be as well taking the control of the same host device, it will “spend” as well one of these available client connections.

Example:

- a MIMO88SG CONFERENCE can support a maximum of **6** WPNET4K / WPNET8K / WPNET12KV units in total and **zero** additional TP-NET client connections
- a MIMO88SG CONFERENCE can support a maximum of **5** WPNET4K / WPNET8K / WPNET12KV units in total and **1** additional TP-NET client connection
- etc...

**\*\* Note:** Includes 2 x MIMO88 units linked in Master-Slave mode (16x16 total matrix size)

## 16 WPNET “R” firmware upgrade

Firstly, it is important to note the software and firmware versions that started to include these retro-compatibility features:

- EclerNet Manager application: **v5.03r9 and later**
- WPNET4KVR and WPNET8KR (retro-compatible versions): **firmware version 1.00r3 and later**
- MIMO88, MIMO88SG, MIMO1212SG, MIMO88 CONFERENCE, MIMO88SG CONFERENCE and MIMO1212SG CONFERENCE: **firmware version 2.02r1 and later**
- NXA4-80, NXA4-200, NXA4-400, NXA6-80 and NXA-6-200: **firmware version 2.02r1 and later**

The process to upgrade a WPNET4KV or WPNET8K hardware unit with a retro-compatible firmware version is the same as with any other EclerNet hardware unit firmware upgrade.

Once a standard WPNET unit is under ENM control, an “R” firmware version must be uploaded. Example with a WPNET4KV model:

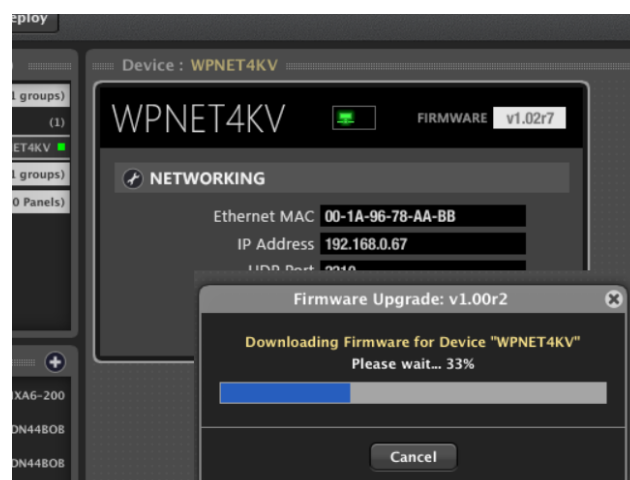
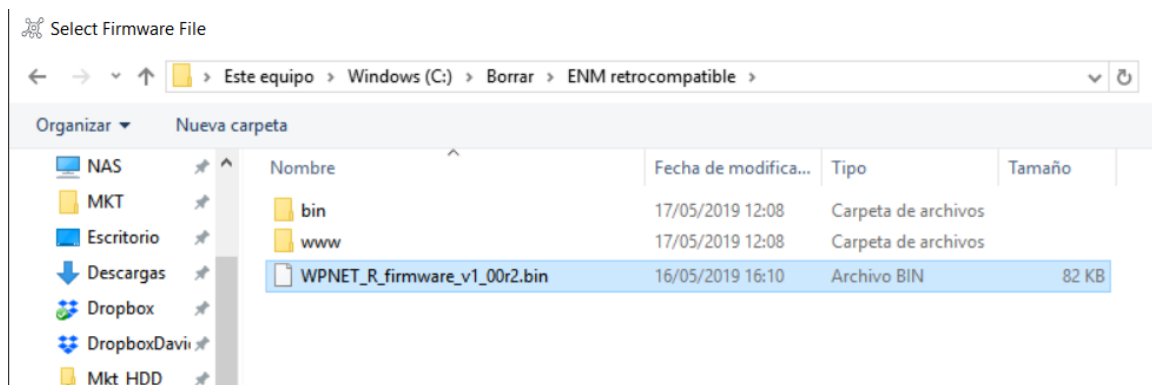

When the upgrade process is finished, the unit will appear again with a new model name, WPNET4KVR (R standing for Retro-compatible), and additional parameters in its detailed view window:

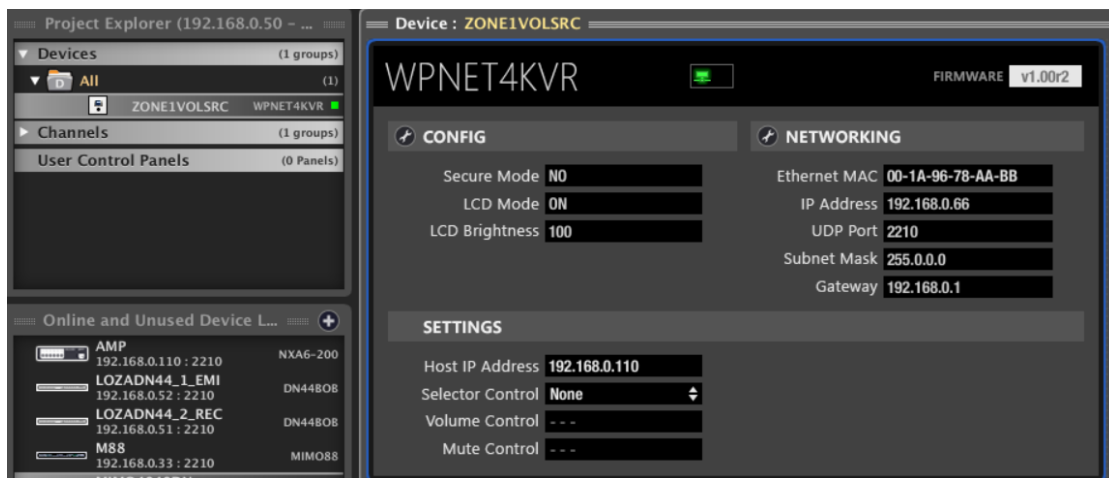

## 17 WPNET4KVR-WPNET8KR-WPNET12KVR & MIMO88 series

MIMO series and WPNET retro-compatible units make use of **Virtual Controls** to communicate and operate. A set of virtual controls (in a range from 1 to 64) must be selected in each WPNET R unit, and also **Virtual Remote Controls** must be adjusted accordingly in the configuration of the MIMO host device to make it work.

This guide provides the basic knowledge about them both regarding WPNET R programming and use. Refer to the EclerNet user manual for further general information about Virtual Controls, Virtual Remote Controls and sources/presets carrousels.

Once a WPNET4KV or WPNET8K (or WPNET12KV) has been upgraded with the retro-compatible firmware version, and it becomes a WPNET4KVR or WPNET8KR (or WPNET12KVR) unit, it must be added to the same project file as the rest of the hardware devices in the EclerNet system:



In the above example one MIMO88 unit, one WPNET4KVR and one WPNET8KR unit have been included in the same project file.

### 17.1 WPNET4KVR / WPNET12KVR configuration

This is the detailed view these panels do have in ENM:

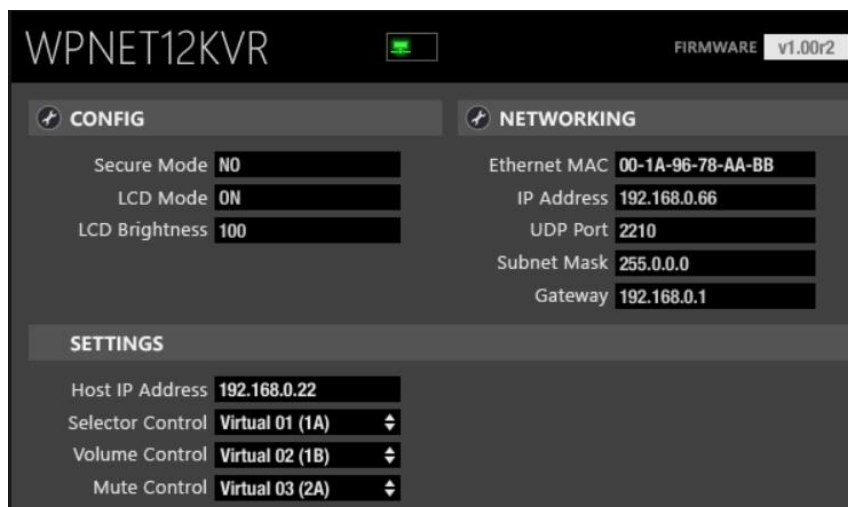
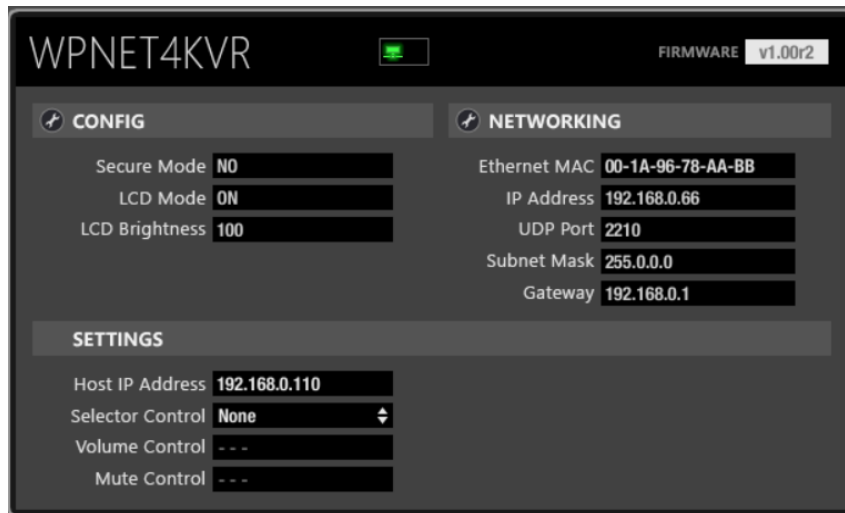

The CONFIG section shows these general parameters:



- **Secure Mode:** when active, a selection of Sources or Presets needs a press & hold action (>3 seconds) of a key in the WPNET4KVR / WPNET12KVR hardware unit to make it effective. Otherwise (unmarked) the selection is effective right after pressing the key once
- **LCD Mode:** LCD brightness mode (ON, DIMMED or TOTALLY OFF) when the panel becomes idle, after several seconds with no user interaction
- **LCD Brightness:** Screen brightness level during normal operation, when the panels is not in idle mode

## 17.2 WPNET4KVR / WPNET12KVR & MIMO series matrix as a host

The parameters (SETTINGS section) that must be configured for the WPNET4KVR or WPNET12KVR in ENM, to define its remote control functions over a MIMO host unit, are:

- **Host IP Address:** IP address of the MIMO hardware unit that the WPNET4KVR / WPNET12KVR wants to remotely control
- **Selector Control (range 1-64):** Virtual Control in the host unit that will be used for source or preset selection, thus pointing to a source or preset carousel in the host unit. It will be triggered by pressing the selection keys in the WPNET4KVR / WPNET12KVR hardware unit.
- **Volume Control (range 1-100):** Virtual Control in the host unit that will be used for volume control, thus pointing to an individual input, output or crosspoint level in the host unit. It will be triggered by rotating the digital knob in the WPNET4KVR / WPNET12KVR hardware unit.
- **Mute Control (range 1 or 100, 2 possible states):** Virtual Control in the host unit that will be used as a MUTE control, thus pointing to an individual input, output or crosspoint MUTE in the host unit. It will be triggered by pressing the digital knob in the WPNET4KVR / WPNET12KVR hardware unit.

All these 3 Virtual Controls can be used, or just some of them, in case that not all 3 functions will be allowed for the profile of end user that will manage the WPNET4KVR / WPNET12KVR unit.

In the following example, these are the selected Virtual Controls (1, 2 and 3):

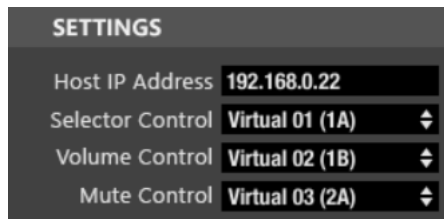

Then, in the host unit, in our example case a MIMO88, these Virtual Controls must be linked to actions.

This first example shows how to link the Virtual Controls assigned to the WPNET4KVR / WPNET12KVR unit to a source selector + volume control + MUTE function in the MIMO88 unit:

1. Add a new VIRTUAL REMOTE PANEL (REMOTES tab in MIMO unit)

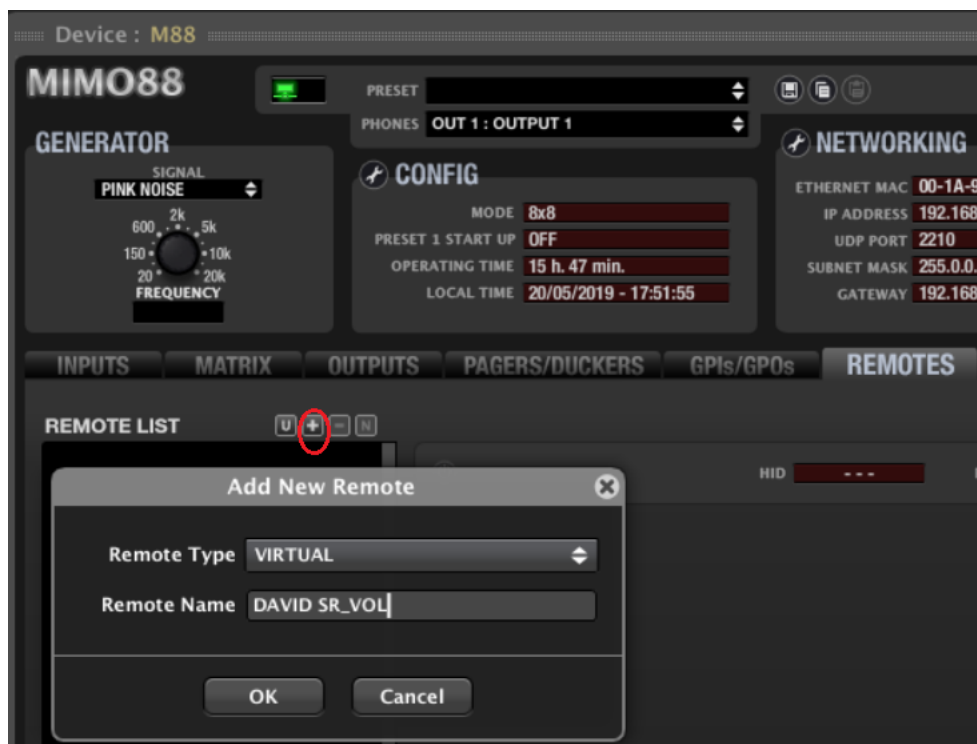



2. Configure it with:

- source selection function, from a previously created carousel of options
- volume control of the selected source (or crosspoint level)
- MUTE control of the selected source (or crosspoint MUTE)



The image shows a dialog box titled "Edit Remote: VIRTUAL" with a close button (X) in the top right corner. The dialog is divided into three sections: SELECTOR, VOLUME, and MUTE. Each section contains several configuration options, each with a dropdown arrow on the right.

Section	Control	Type	Polarity	Other Options
SELECTOR	VIRTUAL1	CAROUSEL	DIRECT	Carousel: 01 - SOURCES1 (INPUTS) Output: OUT 3 : OUTPUT 3
VOLUME	VIRTUAL2	X-FOCUS VOLUME	DIRECT	
MUTE	VIRTUAL3	X-FOCUS MUTE	DIRECT	Mode: TOGGLE

At the bottom of the dialog, there are two buttons: "OK" and "Cancel".

3. Note in the above example:

- Virtual Control 1 points to the SELECTOR function, always associated to a carousel list of options. The chosen carousel is a **SOURCES** (inputs) carousel, meaning this that the WPNET4KVR / WPNET12KVR will be allowed to select among the sources included in this carousel, that will be routed to output #3

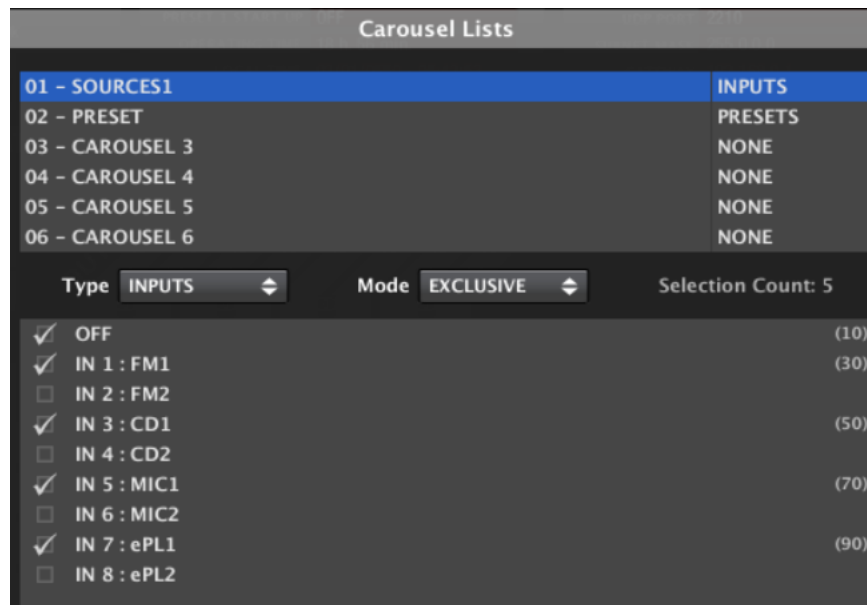

- Virtual Control 2 points to the Cross-Focus Volume: the crosspoint LEVEL control between the selected input and output #3. Turning the digital encoder in the WPNET4KVR / WPNET12KVR unit will define the volume at which the selected input will be sent to output #3
- Virtual Control 3 points to the Cross-Focus MUTE: the crosspoint MUTE control between the selected input and output #3. Pressing the digital encoder in the WPNET4KVR / WPNET12KVR unit will MUTE / UNMUTE the selected input signal that is sent to output #3. **Warning: TOGGLE mode must be selected** to allow MUTE / UNMUTE actions with consecutive encoder press actions

The next example shows how to link the Virtual Controls assigned to the WPNET4KVR / WPNET12KVR unit to a **PRESETS** selector:

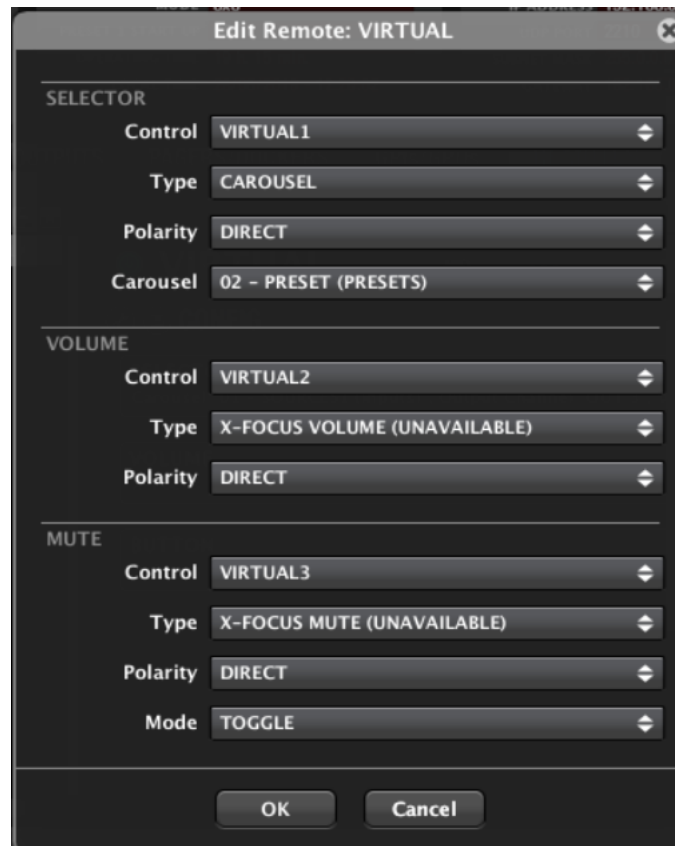

*Note in the above example:*

- Virtual Control 1 points to the SELECTOR function, always associated to a carousel list of options. The chosen carousel in this case is a **PRESETS** carousel, meaning this that the WPNET4KVR / WPNET12KVR will be allowed to select among the PRESETS included in this carousel

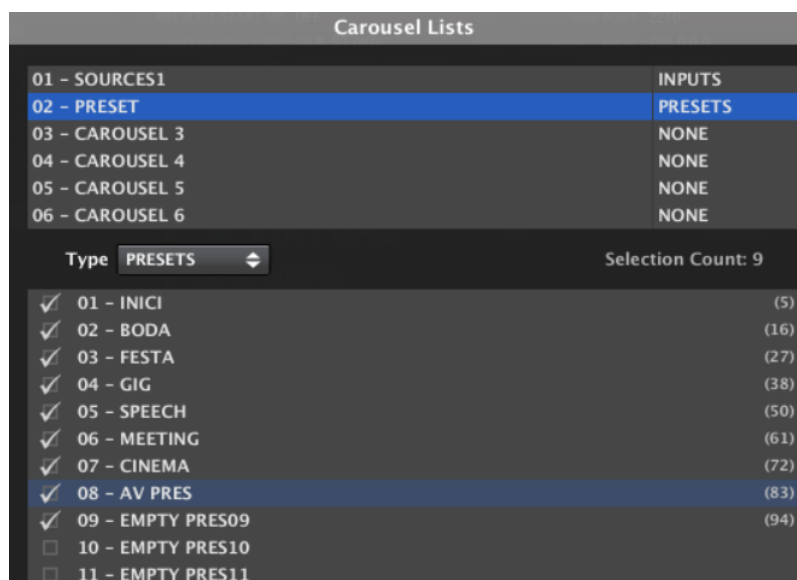

**Note in the above example:**

- Virtual Controls 2 and 3 cannot point to the Cross-Focus VOLUME and/or Cross-Focus MUTE, as there is no notion of a selected source involved when the selection affects to PRESETS and not to SOURCES. That's why these options are shown as X-FOCUS VOLUME (UNAVAILABLE) and X-FOCUS MUTE (UNAVAILABLE)

But there's still an option to make use of Virtual Controls 2 and 3 with a WPNET4KVR / WPNET12KVR panel, controlling a couple of predetermined VOLUME and MUTE controls. This can be achieved **by using two MIMO Events:**

- An analogue event to control a given Volume using Virtual Control 2 (in the example, Output #3 Volume):

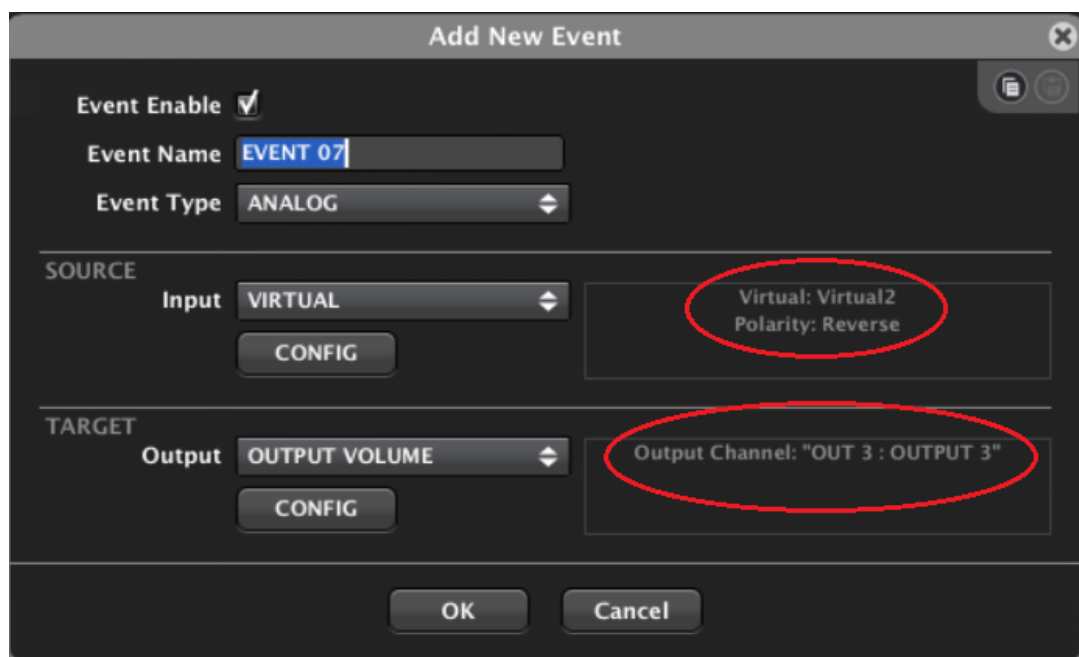

- And a digital event to control a MUTE function using Virtual Control 3 (in the example Output #3 MUTE). **Warning: TOGGLE mode must be selected** to allow MUTE / UNMUTE actions with consecutive encoder press actions:

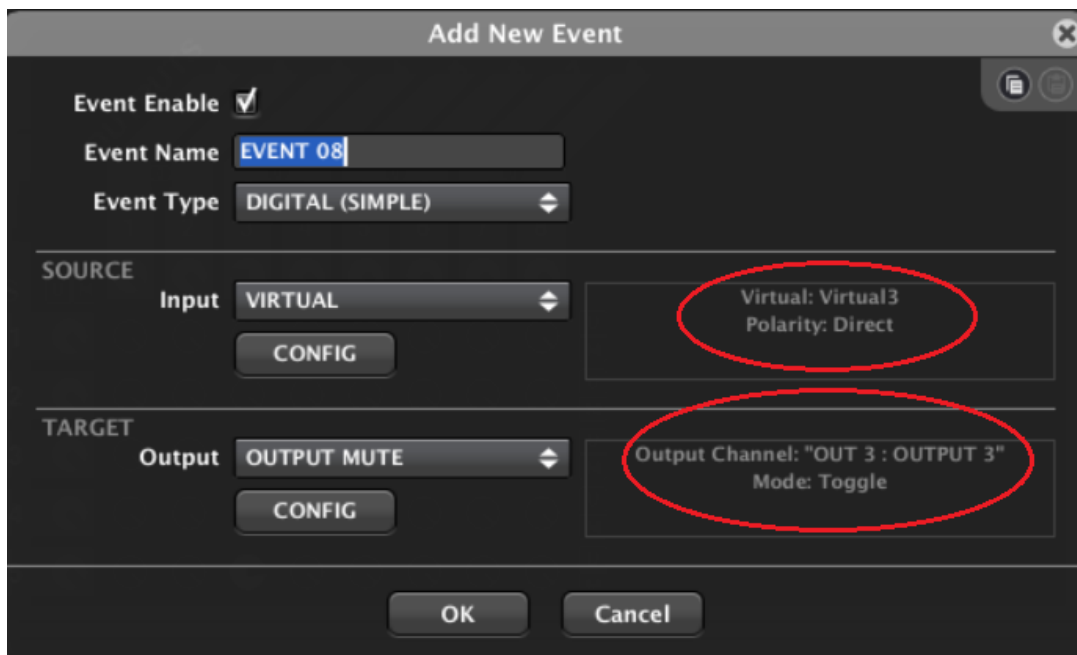

### 17.3 WPNET8KR & MIMO series matrix as a host

In the case of a WPNET8KR unit the control possibilities over a MIMO host unit are just limited to **source or preset selection**, as just one virtual control can be used, the one associated with the 8 available front panel keys:

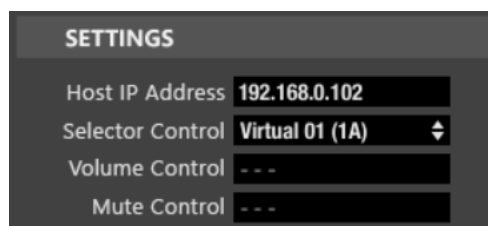

In the WPNET8KR front panel there is no encoder with rotation and push actions available, thus no volume control or MUTE functions can be triggered from it. That's why Volume Control and Mute Control have their selection drop-down menus disabled.

The Virtual Remote Control created in the MIMO unit this time just needs the SELECTOR setup, pointing to the Selector Control used in the WPNET8KR unit (Virtual 1 in the following example):

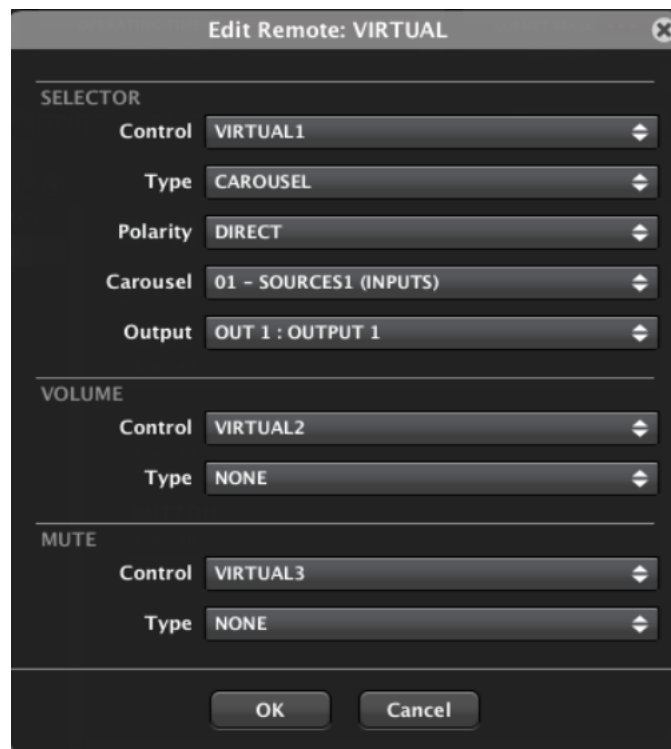

VOLUME and MUTE functions will be set to Type = NONE, thus not making use of any additional Virtual control (even VIRTUAL 2 and 3 are shown in the above example, as Type = NONE for both).

## 18 WPNET4KVR-WPNET8KR-WPNET12KVR & NXA series

NXA series and WPNET retro-compatible units make use of **Virtual Controls** to communicate and operate. A set of virtual controls must be selected in each WPNET R unit, and also **Virtual Remote Controls** must be adjusted accordingly in the configuration of the NXA host device to make it work.

In the case of an NXA series unit as a host, these are the possible Virtual Controls that can be used in a WPNET4KVR, WPNET8KR or WPNET12KVR:

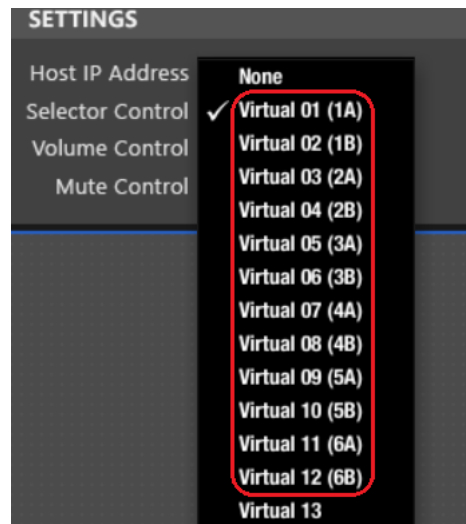

...as these are the ones available for remote control in the NXA hardware devices, from 1A to 6B, in the bellow example for a 6-channel NXA unit:

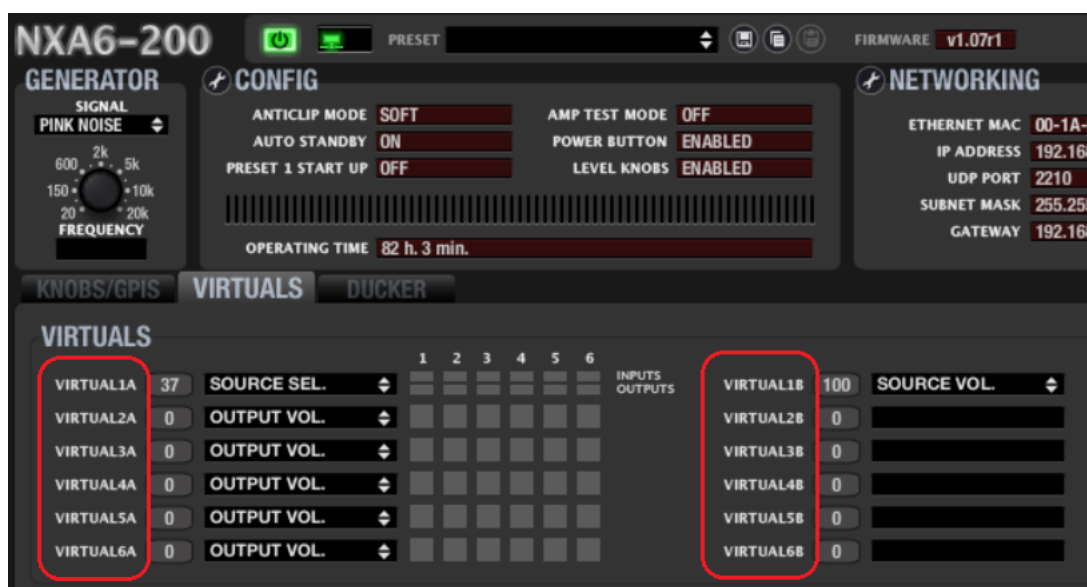

And these are the ones (1A to 4B) available for a 4-channel NXA unit:

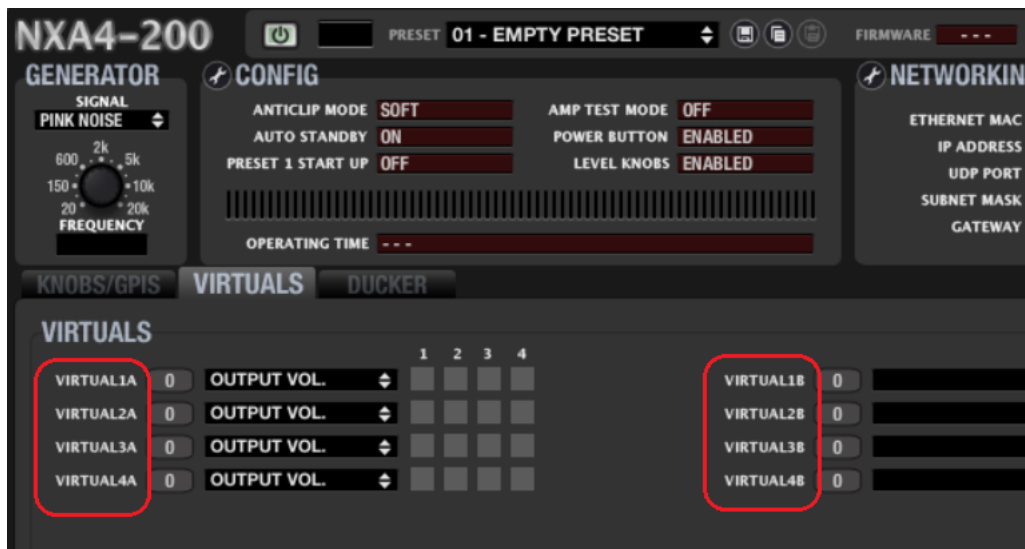

This guide provides the basic knowledge about them both regarding WPNET R programming and use. Refer to the EclerNet user manual for further general information about Virtual Controls, Virtual Remote Controls and sources/presets carrousel.

**A WPNET4KVR or WPNET12KVR can be used to remotely manage an NXA host unit in terms of just source selection and volume control of the selected source.**

Once a WPNET4KV or WPNET8K (or WPNET12KV) has been upgraded with the retro-compatible firmware version, and it becomes a WPNET4KVR or WPNET8KR (or WPNET12KVR) unit, it must be added to the same project file as the rest of the hardware devices in the EclerNet system:

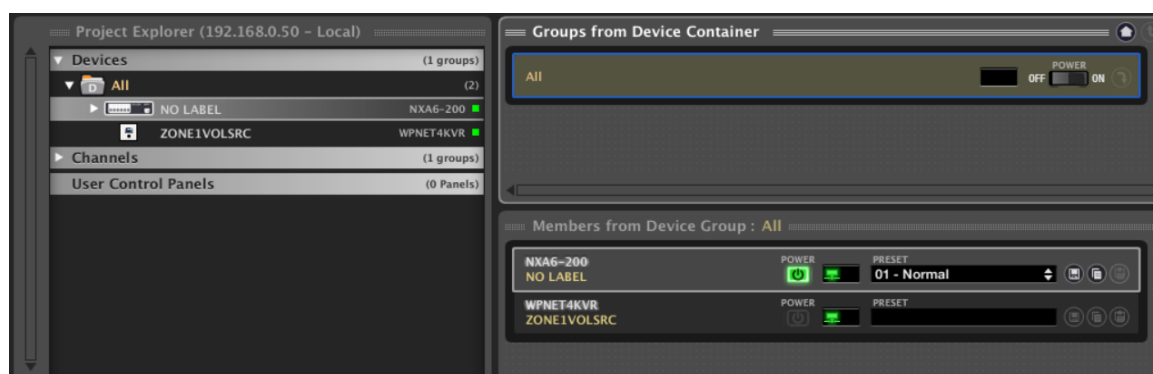

In the above example one NXA6-200 unit and one WPNET4KVR unit have been included in the same project file.



## 18.1 WPNET4KVR / WPNET12KVR configuration

This is the detailed view these panels do have in ENM:

WPNET4KVR
FIRMWARE v1.00r2

**CONFIG**

Secure Mode NO

LCD Mode ON

LCD Brightness 100

**NETWORKING**

Ethernet MAC 00-1A-96-78-AA-BB

IP Address 192.168.0.66

UDP Port 2210

Subnet Mask 255.0.0.0

Gateway 192.168.0.1

**SETTINGS**

Host IP Address 192.168.0.110

Selector Control None ▾

Volume Control - - -

Mute Control - - -

WPNET12KVR
FIRMWARE v1.00r2

**CONFIG**

Secure Mode NO

LCD Mode ON

LCD Brightness 100

**NETWORKING**

Ethernet MAC 00-1A-96-78-AA-BB

IP Address 192.168.0.66

UDP Port 2210

Subnet Mask 255.0.0.0

Gateway 192.168.0.1

**SETTINGS**

Host IP Address 192.168.0.22

Selector Control Virtual 01 (1A) ▾

Volume Control Virtual 02 (1B) ▾

Mute Control Virtual 03 (2A) ▾

The CONFIG section shows these general parameters:



- **Secure Mode:** when active, a selection of Sources needs a press & hold action (>3 seconds) of a key in the WPNET4KVR / WPNET12KVR hardware unit to make it effective. Otherwise (unmarked) the selection is effective right after pressing the key once
- **LCD MODE:** LCD brightness mode(ON, DIMMED or TOTALLY OFF) when the panel becomes idle, after several seconds with no user interaction
- **LCD Brightness:** Screen brightness level during normal operation, when the panels is not in idle mode

## 18.2 WPNET4KVR / WPNET12KVR & NXA series unit as a host

The parameters (SETTINGS section) that must be configured for the WPNET4KVR or WPNET12KVR in ENM, to define its remote control functions over an NXA host unit, are:

- **Host IP Address:** IP address of the NXA hardware target unit that the WPNET4KVR / WPNET12KVR wants to remotely control
- **Selector Control** (range 1A to 6B (6 ch. NXA units) or 1A to 4B (4 ch. NXA units)): Virtual Control in the host unit that will be used for **source selection**, thus linked to the selection options programmed in the target NXA unit. It will be triggered by pressing the selection keys in the WPNET4KVR / WPNET12KVR hardware unit.
- **Volume Control** (range 1-100): Virtual Control in the host unit that will be used for volume control, thus pointing to the “crosspoint” level of the selected source to the desired output(s) in the host unit. It will be triggered by rotating the digital knob in the WPNET4KVR / WPNET12KVR hardware unit.

These 2 Virtual Controls can be used for source selection and volume control, or just the one for the source selection one (and no volume control allowed), depending on the application and end user profile that will manage the WPNET4KVR / WPNET12KVR unit.

In the following example, these are the selected Virtual Controls (1A and 1B):

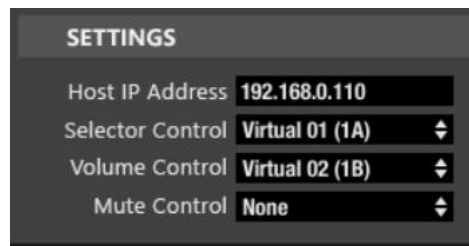

Then, in the host unit, in our example case an NXA6-200, these Virtual Controls must be linked to actions.

The next example shows how to link the Virtual Controls assigned to the WPNET4KVR / WPNET12KVR unit to a source selector + volume control in the NXA6-200 unit:

1. Select the function of Virtual 1A to SOURCE SELECTION:

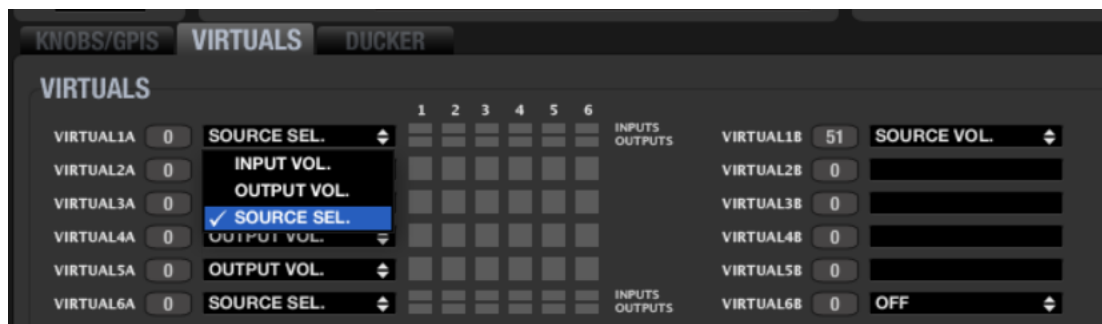

2. Decide which are the available sources for selection (INPUTS, green LEDs = available) and which are the destination outputs for them (OUPUTS, green LEDs = destinations):

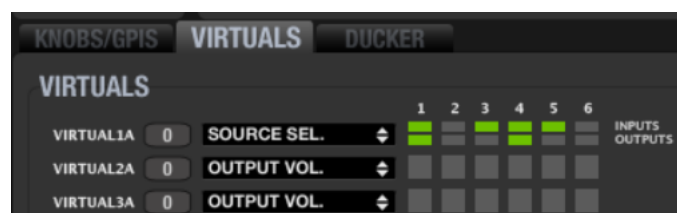

In the above example, inputs # 1, 3, 4 and 5 are available for selection, and the selected one is simultaneously sent to outputs 1 and 4.

3. Virtual 1B can be used for the volume control of the selected source: the amount of signal of the selected source that is being sent to the destination outputs (SOURCE VOL option):

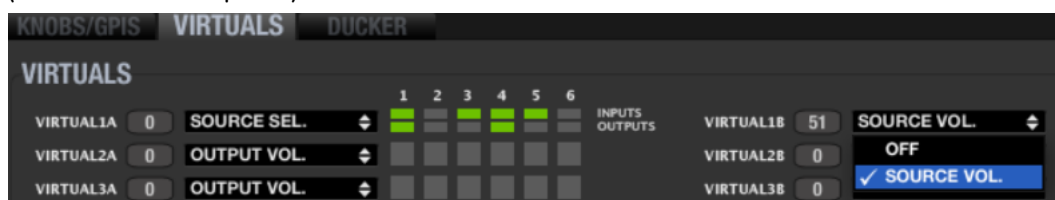

Once configured in this way, the WPNET4KVR or WPNET12KVR wall panel will show on its LCD screen the available sources for selection, showing their names (labels). These labels can be edited from EclerNet Manager, clicking on top of each of them:

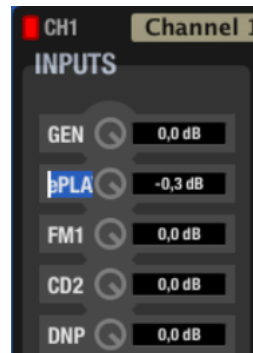

Once a label is edited, it will show in ENM a maximum of 3 characters, but will show more of them in the WPNET4KR LCD screen, as there is more room (characters) available for labels texts in it.

In this example the label is really ePLAYER1 for the first input, IN1 (GENERATOR not counted)



It just shows “eP...” in ENM, but will show the full “ePLAYER1” text in a WPNET4VKR LCD screen.

Pressing the front panel keys in a WPNET4KVR, at the right side of each source selection option, will make the selection effective in the NXA unit:

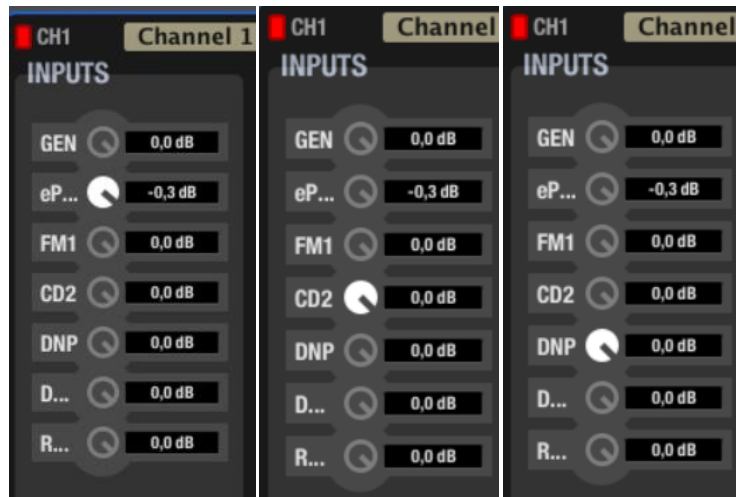

In the above example, the selections made after pressing the keys for the options ePLAYER1, CD2 and DNP shown in the WPNET4KVR screen.

When rotating the digital encoder in the WPNET4KVR, the selected source volume that is sent to the target NXA outputs will be accordingly adjusted. Even no real volume knob is visually affected (moved) in ENM, the value of the virtual control (1B in this case) will be modified, matching the value shown in the WPNET4KVR screen:

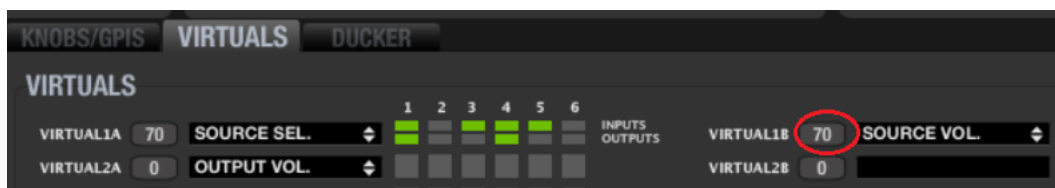

### 18.3 WPNET8KR & NXA series unit as a host

In the case of a WPNET8KR unit the control possibilities over an NXA host unit are just limited to **source selection**, as just one virtual control can be used, the one associated with the 8 available front panel keys:

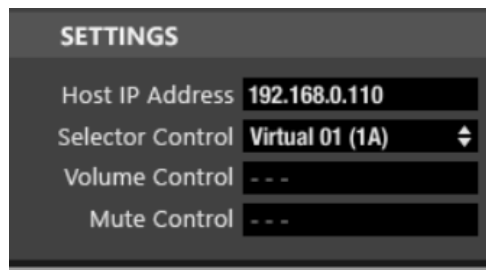

In the WPNET8KR front panel there is no encoder with rotation and push actions available, thus no volume control or MUTE functions can be triggered from it. That's why Volume Control and Mute Control have their selection drop-down menus disabled.

In the next example, the selected Virtual Controls for the Selector function is 1A.

Then, in the host unit, in our example case an NXA6-200, this Virtual Control must be linked to a source selection action:

1. Select the function of Virtual 1A to SOURCE SELECTION:

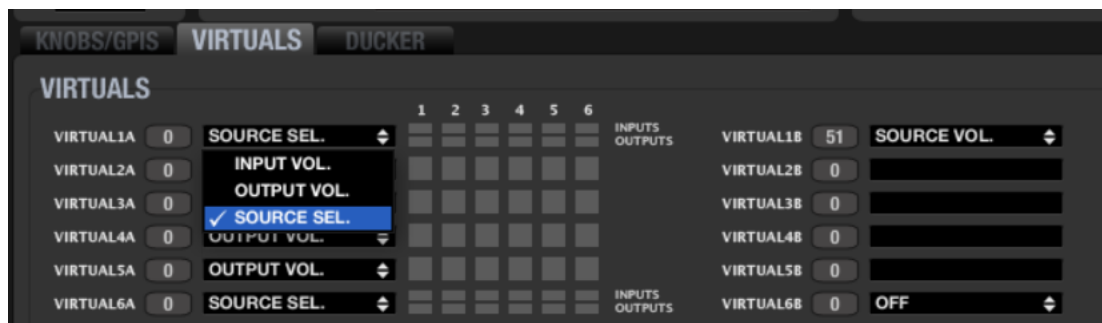

2. Decide which are the available sources for selection (INPUTS, green LEDs = available) and which are the destination outputs for them (OUTPUTS, green LEDs = destinations):

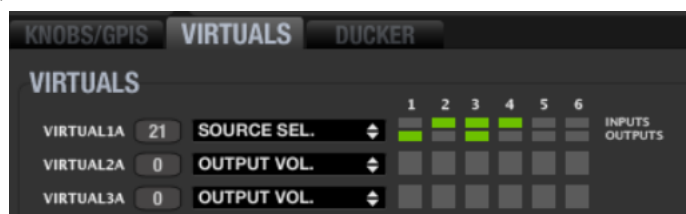

In the above example, inputs # 2, 3 and 4 are available for selection, and the selected one is simultaneously sent to outputs 1 and 3.

## 19 Q&A and GENERAL CONSIDERATIONS

**Q:** Can more than one WPNET R device control simultaneously the same remote functions in the same host device?

**A:** Yes. When 2 or more WPNET R units are programmed pointing to the same host device, and using the same virtual controls, both will behave as “copies” of each other, taking the control of the same parameters.

Example for a WPNET8KR and a WPNET4KVR units controlling the same NXA6-200 host device, and sharing the same source selection function and options (Ins 2,3,4) over outputs 1 and 3:

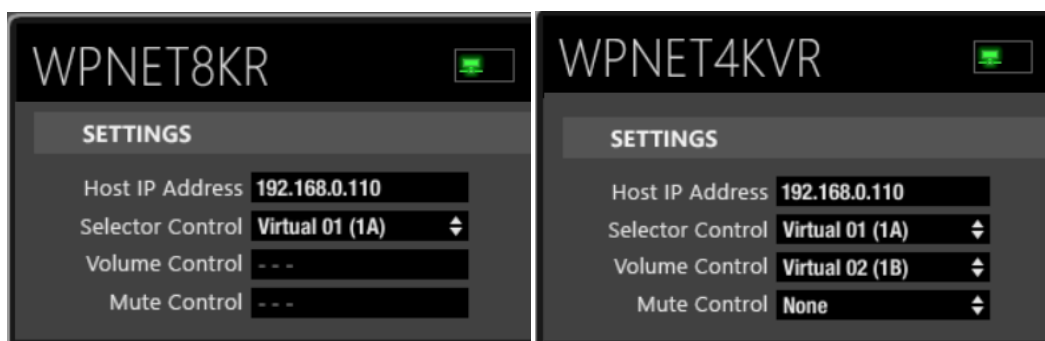

**Q:** In the previous example (two panels controlling the same host device), is each WPNET R panel really “spending” one single communication session, or do both panels share the same one?

**A:** Each panel will spend by itself one communication session with its host device, no matter which controls it takes care of

**Q:** Can one WPNET R unit take the control of more than one host device?

**A:** No. A WPNET R unit uses a point to point communication session with a host device to take its control, and it can’t establish more than one of these sessions simultaneously.



All product characteristics are subject to variation due to production tolerances. **NEEC AUDIO BARCELONA S.L.** reserves the right to make changes or improvements in the design or manufacturing that may affect these product specifications.

For technical queries contact your supplier, distributor or complete the contact form on our website, in [Support / Technical requests](#).

Motors, 166-168 08038 Barcelona - Spain - (+34) 932238403 | [information@ecler.com](mailto:information@ecler.com) | [www.ecler.com](http://www.ecler.com)