



Integrator's Complete Guide to

ConferenceSHOT AV

Enterprise-Class Conferencing System

Document 411-0001-30 Rev A

January 2017

Contents

Overview	1
What's in this Guide	1
Features	1
Unpacking the Conferencing System	2
A Quick Look at the System	5
Back of the Camera	5
Back of the Speaker	6
Installation	7
Before You Install the Camera	7
Don't Void Your Warranty!	7
Cabling Notes	7
Installing the Wall Mount	8
Installing the Camera	9
Installing the Speaker	10
Basic Connections	11
Powering Up the System	11
Status Light	11
Using the Vaddio IR Remote Commander	12
Quick Reference	12
Details	13
Storing a Preset Using the IR Remote Commander	13
Clearing a Preset Using the IR Remote Commander	13
Web Interface	14
Compatible Web Browsers	14
User Access	15
Administrative Access	16
Web Interface Quick Reference	17
Compact Menu View	18
Web Tasks for All Users: Camera Controls	19
Stop or Resume Sending Video	20
Mute the Microphones	20
Mute the Speaker	21
Manage the Camera Ready State	21
Move the Camera	22
Zoom In or Out	22
Move the Camera to a Preset Position	22
Store a Camera Preset	23
Change the Focus	24
Change the Speed of Camera Movements	24
Set Pan Direction	25

- Web Tasks for Administrators: Managing Access and Passwords26
- Web Tasks for Administrators: Adding Room Information to the Screen26
- Web Tasks for Administrators: Configuring Network and Time/Date Settings 27
 - Network Configuration27
 - Specifying Time Zone and NTP Server28
- Web Tasks for Administrators: Configuring Streaming Settings29
 - Edit the USB Device Name29
 - Allow Soft Client Control of the System30
 - Enable or Disable Streaming30
 - Set IP Streaming Settings30
 - Advanced IP Streaming Settings31
- Web Tasks for Administrators: Color, Lighting, and Speed Adjustments 32
 - Adjust the Color Settings32
 - Set Pan, Tilt, and Zoom Speeds32
- Web Tasks for Administrators: Customizing the Audio33
 - Controlling Volume33
 - Fine-Tuning34
- Web Tasks for Administrators: Setting up Macros and Triggers36
 - Writing and Editing Macros36
 - Testing Macros36
 - Defining and Deleting Triggers37
 - Testing Triggers38
- Web Tasks for Administrators: Reboots and Updates39
 - Reboot the Camera39
 - Save and Import or Restore a Configuration39
 - Start a Firmware Update40
 - Camera Switch Settings41
- Web Tasks for Administrators: Contacting Vaddio Technical Support42
- Web Tasks for Administrators: Viewing Diagnostic Logs43
- Telnet Serial Command API44
 - camera home45
 - camera pan45
 - camera tilt46
 - camera zoom46
 - camera focus47
 - camera preset47
 - camera ccu get48
 - camera ccu set49
 - camera recalibrate49
 - camera standby50
 - video mute50

audio volume	51
audio mute	52
trigger	53
streaming settings get	54
network settings get	55
network ping	55
sleep	56
system reboot	56
system factory-reset	57
version	57
history	58
help	58
exit	58
Specifications	59
Troubleshooting and Care	60
Status Light	61
Restoring Default Camera Settings	61
Operation, Storage, and Care	62
Compliance Statements and Declarations of Conformity	63
FCC Part 15 Compliance	63
ICES-003 Compliance	63
European Compliance	64
Warranty Information	65
Index	66

Overview

This guide covers the ConferenceSHOT™ AV system – a camera and detachable speaker available in silver/black or white, together or separately, with or without microphones and a variety of other accessories.

What's in this Guide

This guide covers

- Unpacking and installation
- The system's physical features
- Controlling the camera using the IR remote or web interface
- Controlling the camera using Telnet commands
- Specifications
- Troubleshooting and maintenance
- Warranty and compliance/conformity information

For your convenience, this information is also available in smaller, limited-purpose manuals:

- **Installation Guide for ConferenceSHOT AV Enterprise-Class Conferencing System** (unpacking, physical features, installation, initial power-up)
- **Configuration and Administration Guide for ConferenceSHOT AV Enterprise-Class Conferencing System** (physical features, controlling the camera, and troubleshooting)

Download manuals, dimensional drawings, and other information from www.vaddio.com/support.



Features

- Integrated HD camera and audio system ideal for huddle rooms and small to medium conference rooms
- Audio inputs for two Vaddio MicPOD table or ceiling microphones
- Audio output for optional matching speaker – or integrate into existing audio infrastructure
- 2.14 Megapixel effective, native 1080p/60 HD image sensor
- 10x optical zoom, horizontal field of view of 74° in super-wide mode
- Simultaneous uncompressed USB 3.0 and IP (H.264) video + full-duplex audio streaming
- Precise pan and tilt movements at up to 90° per second with smooth, silent direct-drive motors
- Universal Video Class (UVC) and Universal Audio Class (UAC) drivers supported in Windows®, Mac®, and Linux operating systems, compatible with most UC conferencing applications
- Presenter-friendly IR remote control
- Integration-ready Telnet control
- Enterprise-class IT support with full web controls for remote management

Unpacking the Conferencing System

Make sure you received all the items you expected. Here are the packing lists for the ConferenceSHOT AV system.

Caution:

Use the power supply shipped with the camera. Using a different power supply may create an unsafe operating condition or damage the camera, and will void the warranty.

Caution

Always support the camera's body when picking it up. Lifting the camera by its head or mounting arm will damage it.



ConferenceSHOT AV camera kit

North America: 999-9995-000 (black/silver) or 999-9995-000W (white)

Europe and UK: 999-9995-001 (black/silver) or 999-9995-001W (white)

Australia and New Zealand: 999-9995-009 (black/silver) or 999-9995-009W (white)

- ConferenceSHOT AV camera
- Vaddio IR Remote Commander
- PoE+ power injector with AC cord set(s)
- Ethernet cable, 10 ft (3 m)
- USB 3.0 cable, 6 ft (1.8 m)
- HDMI cable, 6 ft (1.8 m)
- Molex connector

ConferenceSHOT AV speaker kit

All locales: 998-9995-003 (black) or 998-9995-003W (white)

- Speaker
- Wall mount kit
- Cable to camera, 6 in. (15 cm)

ConferenceSHOT AV system with single ceiling microphone

North America: 999-9995-100 (black/silver) or 999-9995-100W (white)

Europe and UK: 999-9995-101 (black/silver) or 999-9995-101W (white)

Australia and New Zealand: 999-9995-109 (black/silver) or 999-9995-109W (white)

- ConferenceSHOT AV camera
- ConferenceSHOT AV speaker with cable
- Vaddio IR Remote Commander
- Wall mount kit, black or white according to camera and speaker color
- One ceiling MicPOD
- PoE+ power injector with AC cord set(s)
- Ethernet cable, 10 ft (3 m)
- USB 3.0 cable, 6 ft (1.8 m)
- HDMI cable, 6 ft (1.8 m)
- Molex connector

ConferenceSHOT AV system with two ceiling microphones

North America: 999-9995-200 (black/silver) or 999-9995-200W (white)

Europe and UK: 999-9995-201 (black/silver) or 999-9995-201W (white)

Australia and New Zealand: 999-9995-209 (black/silver) or 999-9995-209W (white)

- ConferenceSHOT AV camera
- ConferenceSHOT AV speaker with cable
- Vaddio IR Remote Commander
- Wall mount kit, black or white according to camera and speaker color
- Two ceiling MicPODs
- PoE+ power injector with AC cord set(s)
- Ethernet cable, 10 ft (3 m)
- USB 3.0 cable, 6 ft (1.8 m)
- HDMI cable, 6 ft (1.8 m)
- Molex connector

ConferenceSHOT AV system with single tabletop microphone

North America: 999-9995-300 (black/silver) or 999-9995-300W (white)

Europe and UK: 999-9995-301 (black/silver) or 999-9995-301W (white)

Australia and New Zealand: 999-9995-309 (black/silver) or 999-9995-309W (white)

- ConferenceSHOT AV camera
- ConferenceSHOT AV speaker with cable
- Vaddio IR Remote Commander
- Wall mount kit, black or white according to camera and speaker color
- One tabletop MicPOD
- PoE+ power injector with AC cord set(s)
- Ethernet cable, 10 ft (3 m)
- USB 3.0 cable, 6 ft (1.8 m)
- HDMI cable, 6 ft (1.8 m)
- Molex connector

ConferenceSHOT AV system with two tabletop mics

North America: 999-9995-400 (black/silver) or 999-9995-400W (white)

Europe and UK: 999-9995-401 (black/silver) or 999-9995-401W (white)

Australia and New Zealand: 999-9995-409 (black/silver) or 999-9995-409W (white)

- ConferenceSHOT AV camera
- ConferenceSHOT AV speaker with cable
- Vaddio IR Remote Commander
- Wall mount kit, black or white according to camera and speaker color
- Two tabletop MicPODs
- PoE+ power injector with AC cord set(s)
- Ethernet cable, 10 ft (3 m)
- USB 3.0 cable, 6 ft (1.8 m)
- HDMI cable, 6 ft (1.8 m)
- Molex connector

ConferenceSHOT AV basic camera system

North America: 999-9995-500 (black/silver) or 999-9995-500W (white)

Europe and UK: 999-9995-501 (black/silver) or 999-9995-501W (white)

Australia and New Zealand: 999-9995-509 (black/silver) or 999-9995-509W (white)

- ConferenceSHOT AV camera
- Vaddio IR Remote Commander
- One tabletop MicPOD
- PoE+ power injector with AC cord set(s)
- HDMI audio embedder kit
- Ethernet cable, 10 ft (3 m)
- USB 3.0 cable, 6 ft (1.8 m)
- HDMI cable, 6 ft (1.8 m)
- Molex connector

Download manuals, dimensional drawings, and other information from www.vaddio.com/support.

A Quick Look at the System



- **Camera and zoom lens:** The ConferenceSHOT 10 camera features a 10X optical zoom lens (11X in Super-Wide mode).
- **IR sensors:** Sensors in the front of the camera base receive signals from the remote. Make sure there's nothing directly in front of the camera base, and point the remote at the camera.
- **Status light:** The multi-colored LED indicates the camera's current state.
- **Speaker:** Far-end audio for small conference rooms.

Back of the Camera



- **Network PoE+** – 10/100/1000 Ethernet port; IP streaming and control via web interface
- **USB 3.0** – Type B media device connector; streams uncompressed UVC standard video and UAC standard audio
- **EasyMIC ports** – Connect up to two Vaddio EasyMIC microphones
- **Audio output** – Line level differential audio and 12 VDC power output to the optional amplified speaker or other audio infrastructure

Back of the Speaker



Use the provided speaker cable to connect the speaker to the camera.

Installation

This section covers siting the camera, installing the mount, and installing the camera and speaker.

Before You Install the Camera

- Choose a camera mounting location that will optimize camera performance. Consider camera viewing angles, lighting conditions, line-of-sight obstructions, and in-wall obstructions where the camera is to be mounted.
- Ensure that the camera body can move freely and point away from the ceiling and lights. The camera will not perform well if it is pointed toward a light source such as a light fixture or window.
- Follow the installation instructions included with the camera mount.

Note

Inverted installation is not recommended when the ConferenceSHOT speaker is to be used.

Don't Void Your Warranty!

Caution

This product is for indoor use. Do not install it outdoors or in a humid environment without the appropriate protective enclosure. Do not allow it to come into contact with any liquid.

Use only the power supply included with this product. Using a different one will void the warranty, and could create unsafe operating conditions or damage the product.

Do not install or operate this product if it has been dropped, damaged, or exposed to liquids. If any of these things happen, return it to Vaddio for safety and functional testing.

Learn more at www.vaddio.com/products.

Cabling Notes

For RJ-45 connections, use Cat-5e or better cable and high-quality standard RJ-45 connectors.

Note

Use standard RJ-45 connectors and a good crimping tool. Do not use pass-through RJ-45 connectors. Poorly crimped connectors can damage the connectors on the product, cause intermittent connections, and degrade signal quality. Test cable pin-outs and continuity before connecting them.



Intact – Contact fingers will make reliable contact with the cable connector



Damaged – Some contact fingers are bent and will NOT make reliable contact with the cable connector

Pro Tip

Label all cables at both ends.

Installing the Wall Mount

If you install the camera wall mount to drywall, use the wall anchors provided with the wall mount.

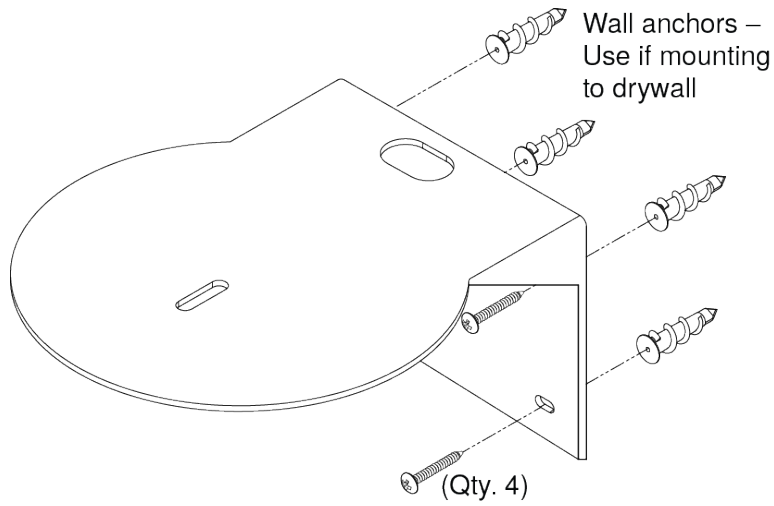

Note

Inverted installation is not recommended when the ConferenceSHOT speaker is to be used.

Installing the Camera

Caution

Before you start, be sure you can identify all cables correctly. Connecting a cable to the wrong port can result in equipment damage.

Caution:

Check Cat-5 cables for continuity before using them. Using the wrong pin-out may damage the camera system and void the warranty. Pro tip: Label your cables.

1. Route the cables through the opening in the mounting shelf.
2. Connect all required cables to the camera.
3. Secure the camera to the mounting shelf using the mounting screw ($\frac{1}{4}$ -20 x .375 in.) supplied with the camera.

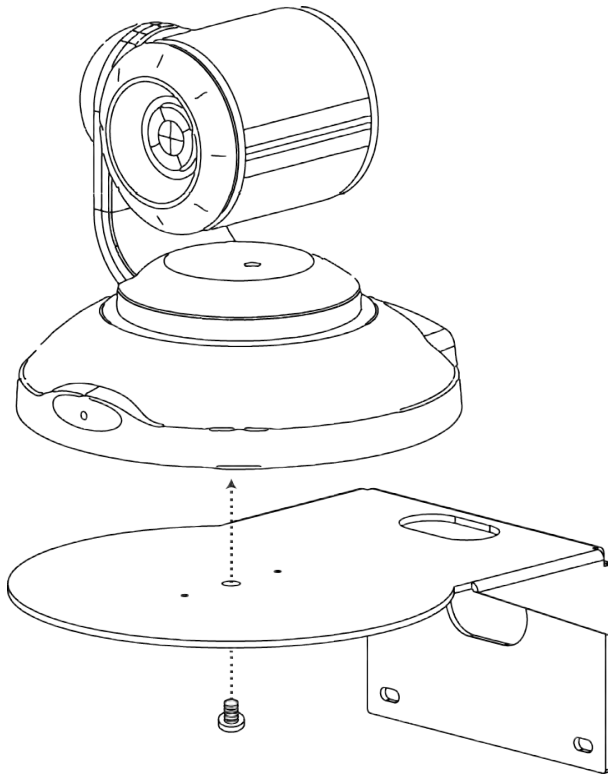

Note

If the camera is jostled or bumped, it may require a pan-tilt reset.

Installing the Speaker

1. If you are adding a speaker to a previously-installed ConferenceSHOT AV camera, you may need to remove the camera from the mounting shelf to connect the speaker cable.
2. Install the camera on the mounting shelf if you have not already done so .
3. Slide the speaker part of the way onto the mounting shelf.
4. Connect the speaker cable (power and line level signal) to the speaker.
5. Slide the speaker into place.

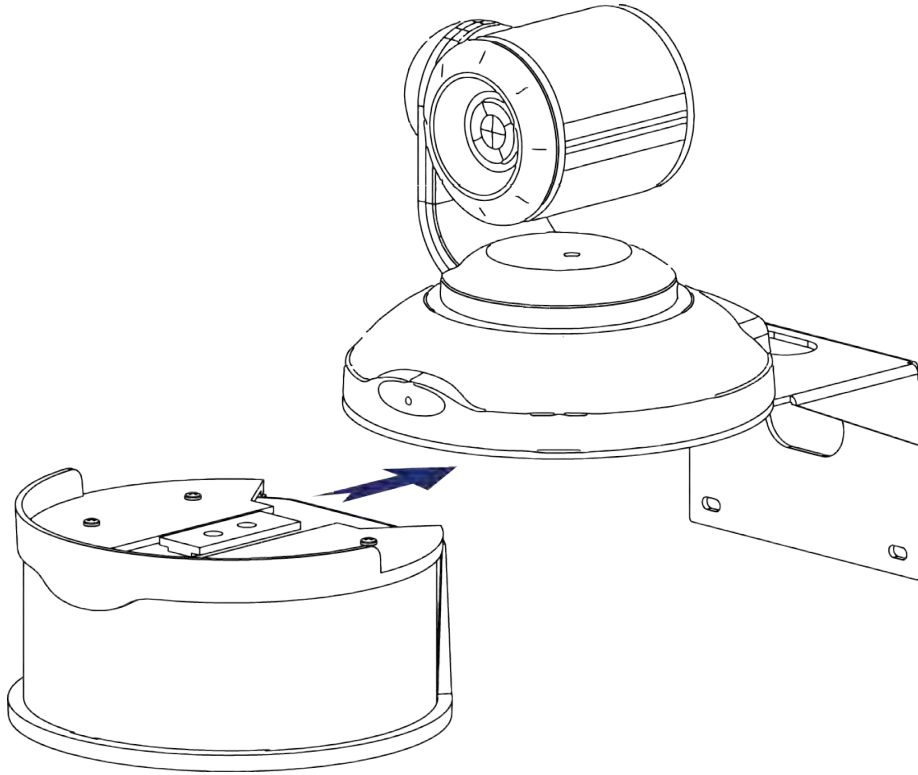

Basic Connections

Here is an example of how the camera might be set up in a medium-size conference room. In this setup, a PC uses a unified communications conferencing application to manage the camera and connected microphones and speaker.

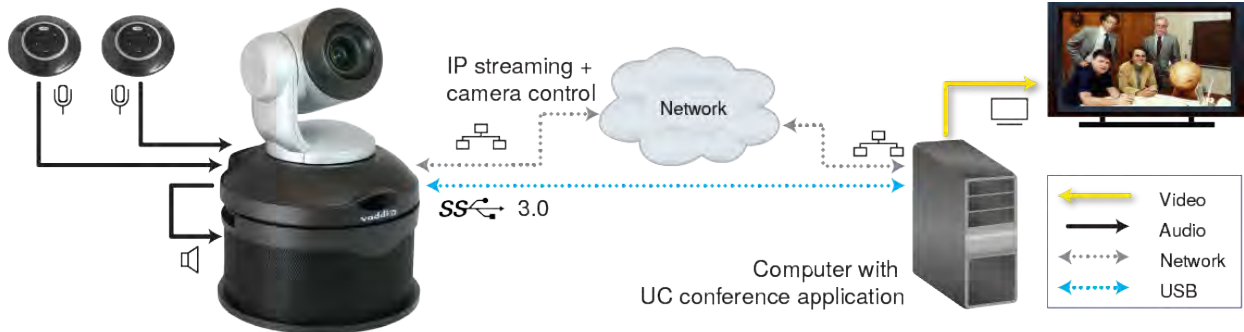

Powering Up the System

Connect camera power.

The camera will initialize and move. This will take a few seconds. When an image is available, the camera is ready to accept control information.

Status Light

The light in the camera's base indicates its current state.

- Blue – Camera is active
- Purple – Standby mode or booting
- Yellow – Firmware update is in progress
- Blinking blue – Video mute is on (Pro A/V color scheme) or USB cable is disconnected (UC color scheme)
- Blinking yellow – Motor out of calibration
- Blinking purple – Error

Caution

Do not remove power or reset the camera while the indicator is yellow, showing a firmware update in progress. Interrupting a firmware update can make the camera unusable.

Using the Vaddio IR Remote Commander

The remote provides basic camera control.

Quick Reference

What do you need to do?	Button(s)
Power on or standby	Power (green button at top right)
Select the camera to control (if this remote controls more than one)	Camera Select buttons 1 through 3 (second row on the remote)
Discover the camera's IP address	Data Screen button (top left) – press and hold for 3 seconds
Move the camera	Arrow buttons and Home button (dark red)
Move the camera to a preset position	Position Preset buttons 1 through 6 (bottom two rows)
Focus the camera	Auto Focus button (near arrow buttons) Manual Focus buttons Near and Far (below Zoom Speed buttons)
Mute the microphone(s)	Mic Mute button (center)
Change the speaker volume	Volume buttons (center left)
Change zoom	Zoom buttons – T (telephoto) to zoom in and W (wide-angle) to zoom out. modes (center right)
Adjust for excess light behind the camera's subject	Back Light button (top center)
Correct a motor calibration fault condition (blinking yellow light)	Pan-Tilt Reset button (center right, beside arrow buttons)

Details

The Vaddio remote provides the following functions:

Data Screen – Press and hold for 3 seconds to display the camera's IP address and MAC address on the near-end display. Press momentarily to dismiss the information.

Back Light – Use or turn off back light compensation.

Power – Switch the selected camera on or off.

Power indicator – Shows power on, IR transmission, and battery level.

Camera Select – In multi-camera installations, selects the camera to be controlled. See [Camera Switch Settings](#) for information on configuring the camera as camera 1, 2, or 3.

Pan/Tilt (arrow button) controls and Home button – Control the camera's position.

Std. Pan and Rev. Pan – Control how the camera responds to the arrow buttons. Helpful for ceiling-mounted cameras.

Pan/Tilt Reset – Recalibrate the pan and tilt motors. If the camera gets jostled, you may need to push this button to ensure that the camera moves accurately to its home and preset positions.

Auto Focus – Switch the camera to Auto-Focus mode.

Volume Increase and Decrease – Control the speaker volume.

Mic Mute – Stop sending audio.

Manual Focus – Switch the camera to Manual Focus mode.

Near (-) adjustment – Moves the focus nearer when in manual focus mode.

Far (+) adjustment – Moves the focus farther when in manual focus mode.

Position Presets 1 through 6 – Move the camera to a predefined position.

Preset – Save the camera's current position as one of the numbered presets.

Reset – Clear the saved position presets.

Storing a Preset Using the IR Remote Commander

Position the camera. Then hold down the **Preset** button and press one of the numbered preset buttons.

Clearing a Preset Using the IR Remote Commander

Press and hold the **Reset** button while pressing the preset number you want to clear.



Web Interface

The camera provides a web interface to allow control via an Ethernet network connection, using a browser. The web interface gives the user more control over the camera than the IR remote offers.

The web interface allows user-level camera control and password-protected administrative access to tasks such as setting passwords, changing the IP address, viewing diagnostics, and installing firmware updates.

If the LAN has a DHCP server, the camera will get its IP address, gateway and routing information automatically and you will be able to browse to it. In the absence of a DHCP server, the camera's default IP address is 169.254.1.1 and its subnet mask is 255.255.0.0.

You can configure the camera's static IP address either through the network or from a computer connected directly to its Ethernet port. You may need a crossover cable.

To display the camera's IP address:

Press and hold the Data Screen button on the remote. After 3 seconds, the room display presents the information.

Compatible Web Browsers

Supported web browsers:

- Chrome® (latest version),
- Firefox® (latest version),
- Microsoft® Internet Explorer® (versions 8 through 11)
- Safari® (versions 6 and 7)
- Microsoft® Edge

Other browsers may also work.

User Access

By default, the web interface opens to the Camera Controls page without requiring a login. If the administrator has changed the guest access setting, you will need to log in.

The default user password is `password`. Only the camera control page is available with user-level access.

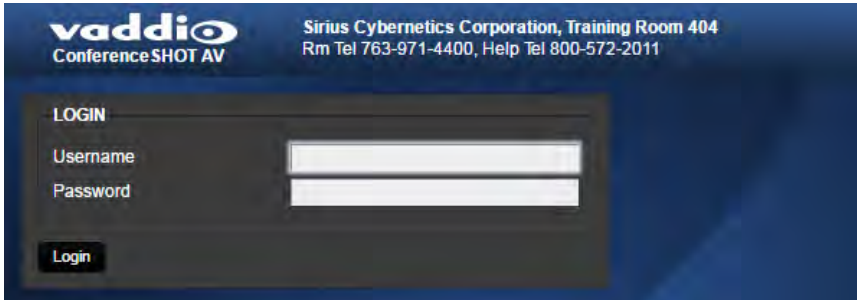

If you are not logged in using the admin account, the Admin button on the Camera Controls page opens the admin login dialog. The default admin password is `password`. The admin has access to all pages of the web interface.



Administrative Access

If you are on the Camera Control screen and no other screens are available, you're logged in at the user level, or guest access is enabled and you're not logged in at all. Use the Admin button to open the login dialog.

When you log in as Admin, all the admin navigation buttons appear on the left side of the screen. In addition to Camera Controls, you also have access to:

- Camera Settings – Additional control over camera behavior related to camera movement and color management.
- Audio – Control and adjust audio inputs and outputs individually
- Control Devices – Define actions and sequences to execute via third-party control devices.
- Streaming – USB device settings and IP (H.264) streaming.
- Room Labels – Information to display on the web interface screens, including the conference room name and phone number and the in-house number for AV assistance.
- Networking – Ethernet configuration.
- Security – Set passwords and manage guest access.
- Diagnostics – View or download logs when troubleshooting issues.
- System – View firmware version and switch settings, reboot, restore factory defaults, and run firmware updates.
- Help – Tech support contact information and a link to the product information library on the Vaddio website.
- Logout – Leave the web interface in a password-protected state. If guest access is on, this returns the web interface to the Camera Controls page at guest access level.

Web Interface Quick Reference

Where to find the controls you need right now.

What do you need?	Go to this page
Camera operation <ul style="list-style-type: none"> ■ Move or zoom the camera ■ Set the speed for pan, tilt, or zoom motions ■ Focus the camera (Focus button reveals the focus control) ■ Move to a camera preset ■ Put the camera into or bring it out of standby mode 	Camera Controls (guest access page)
Audio operation <ul style="list-style-type: none"> ■ Mute the microphones ■ Silence the speaker ■ Set speaker volume ■ Set microphone volume 	Camera Controls (guest access page)
Camera behavior <ul style="list-style-type: none"> ■ Set motors for inverted operation (Settings button reveals the control) ■ Set or clear camera presets 	Camera Controls (guest access page)
Camera behavior <ul style="list-style-type: none"> ■ Specify whether to use automated adjustments (auto-iris, auto white balance, backlight compensation) 	Camera Settings
Camera behavior <ul style="list-style-type: none"> ■ Normal or super-wide mode ■ Status light color scheme (Pro A/V or UC) ■ UVC-Compliant or Client Custom USB streaming ■ Image flip ■ IR frequency – respond to the IR remote as camera 1, 2, or 3 	System: DIP Switches
Camera adjustments <ul style="list-style-type: none"> ■ Color settings (Iris, iris gain, red gain, blue gain, detail, chroma, gamma) ■ Specify global speed settings for camera movements 	Camera Settings
Camera adjustment: Recalibrate pan and tilt motors	System : Firmware
Access management <ul style="list-style-type: none"> ■ Guest access ■ Account passwords ■ Automatic logout for idle sessions 	Security
USB and IP streaming settings	Streaming
Other IP settings <ul style="list-style-type: none"> ■ Hostname ■ DHCP or static addressing ■ Static: IP address, subnet mask, gateway 	Networking
Date and time, time zone, and NTP server	Networking
Information about the camera <ul style="list-style-type: none"> ■ Room location and phone number ■ Help desk phone number 	Room Labels

What do you need?	Go to this page
Reboot or reset to factory defaults	System: Firmware
Firmware <ul style="list-style-type: none"> ■ Current version information ■ Save (export) and restore (import) configuration ■ Firmware update (system) 	System: Firmware
Firmware update (microphones)	System: Peripherals
Vaddio Technical Support contact information	Help
Diagnostic logs	Diagnostics

Compact Menu View

By default, the navigation buttons display an icon and a text label.

The web interface provides a compact view of the menu buttons along with the standard view. The button at the bottom of the menu toggles between the two views.



Web Tasks for All Users: Camera Controls

CAMERA CONTROLS PAGE

The Camera Controls page provides most of the same controls as the IR Remote Commander, along with some that are not available from the remote:

- [Pan, tilt, zoom, or return to "home" position](#)
- [Stop or resume transmitting live camera video](#) (video mute)
- [Mute or unmute the microphone\(s\)](#)
- Change the speaker volume
- [Put the camera in standby](#) or bring it back to the ready state
- [Focus manually](#) or set auto-focus
- [Set speeds for camera movements](#)
- [Set](#) or [move to](#) camera presets
- [Set the way the camera responds](#) to the arrow buttons on the remote

Note

Administrators can also customize the camera's home position from this page. See [Store a Camera Preset](#).



Stop or Resume Sending Video

Use the Mute button to temporarily stop video from the camera without placing it in standby - for example, when you need to confer privately with another person in the room. Remember that the mute button does not mute the room's microphones. In video mute mode, the camera transmits blue or black video, with a message that the video is muted.

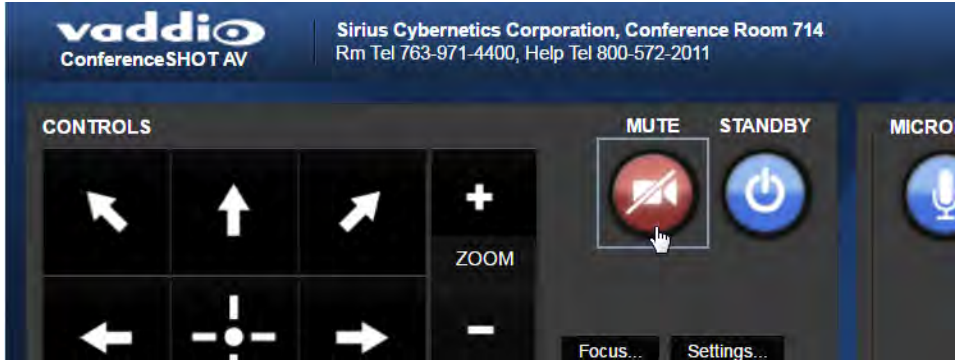

Mute the Microphones

Use the Microphone button to temporarily stop sending audio.

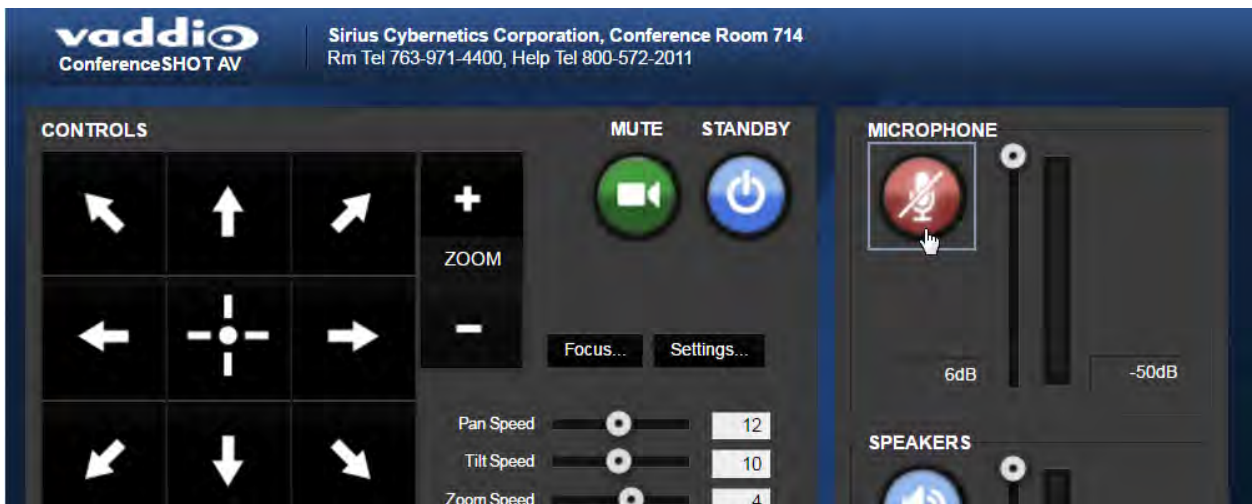

Mute the Speaker

Use the Speaker button to silence the audio from the far end.



Manage the Camera Ready State

Use the Standby button to switch between low-power (standby) and ready states.

In standby mode, the button is red and the screen presents the message "Device is in standby." On entering standby mode, the camera pans 90° from center and 30° downward.

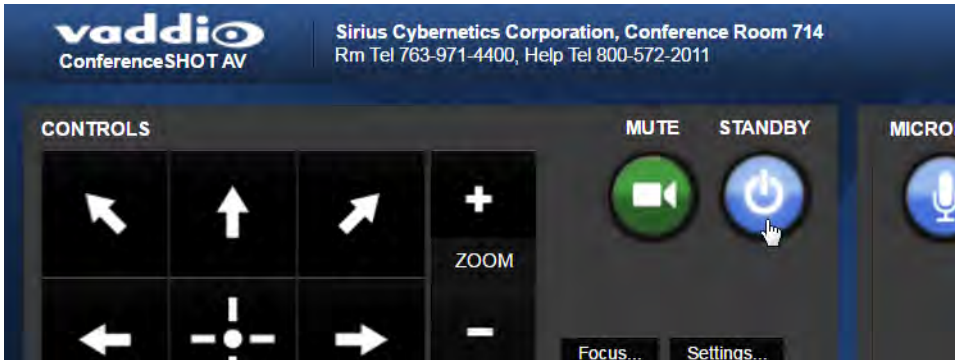

Move the Camera

Use the arrow buttons for camera pan and tilt. The center button moves the camera to the home position.

Zoom In or Out

Use the Zoom + button to zoom in and the Zoom - button to zoom out.

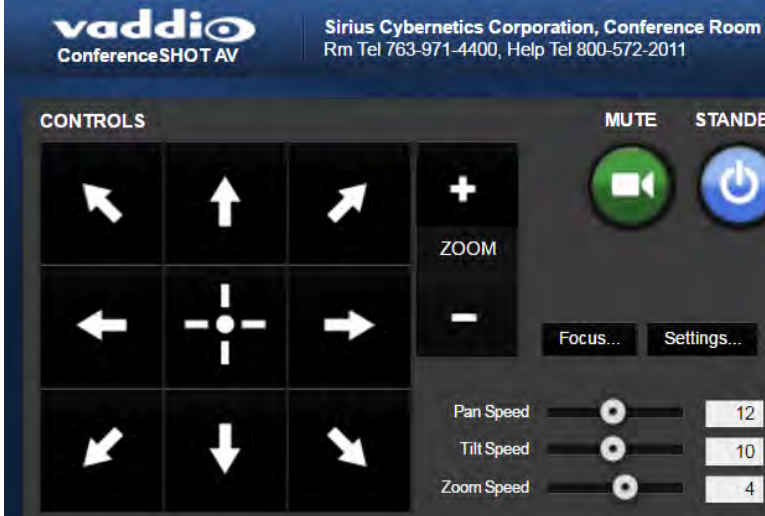

Move the Camera to a Preset Position

Use the numbered Preset buttons to move the camera to any of its programmed positions. If you select a preset that has not yet been programmed, nothing happens.

Store a Camera Preset

1. Set up the camera shot, then use the Store button to open the Store Preset box.
2. Click one of the preset buttons. If you are logged in as admin, this box provides the option to store the shot as a numbered preset or as the Home position.
3. To save the current CCU settings along with the camera position, check Store with Current Color Settings.
4. Store the preset.

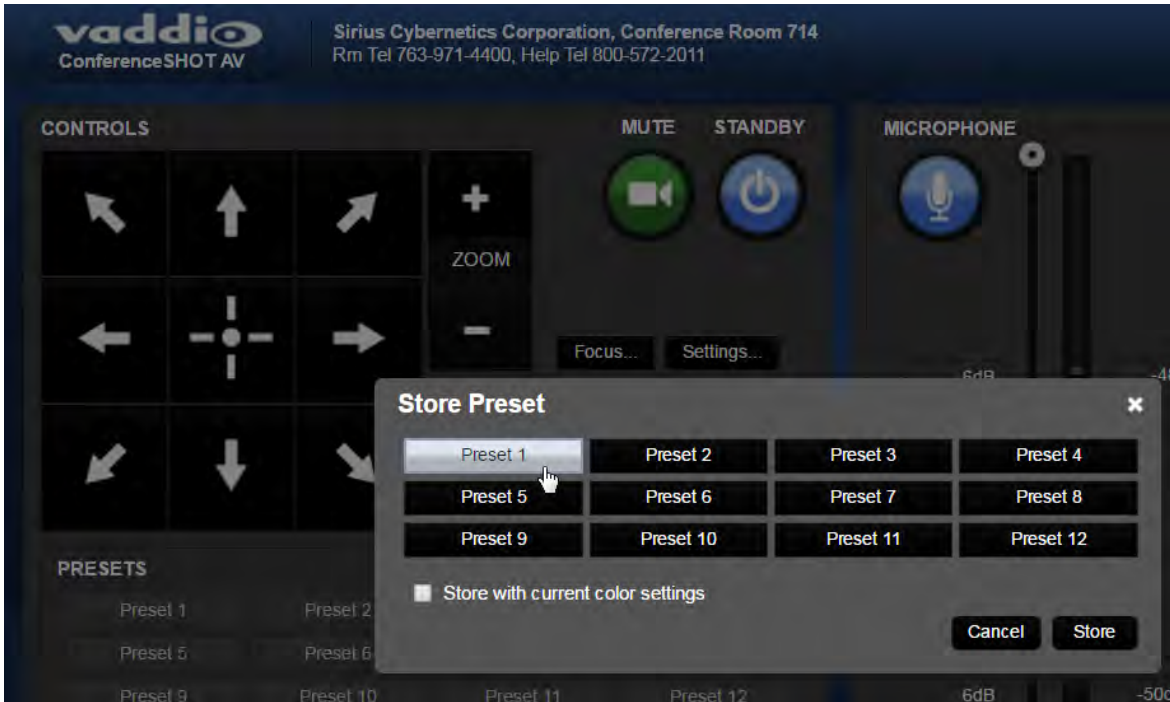

Change the Focus

Open the Focus control to select Auto-focus, or set manual focus with the + (near) and – (far) buttons. These buttons are not recognized when the Auto Focus box is checked.



Change the Speed of Camera Movements

Use the speed sliders to adjust the speed of movements that you control with the buttons for pan, tilt and zoom. For tight shots, slower is usually better.

Set Pan Direction

By default, the arrow buttons move the camera in the direction that viewers at the far end would see. If you face the camera and use the left arrow button, the camera pans to your right.

To switch the camera pan direction to the near end point of view, use the Settings button to open the pan and tilt direction box. Then set Pan Direction to Inverted.



Web Tasks for Administrators: Managing Access and Passwords

SECURITY PAGE

Things you can do on this page:

- Change the password for the admin account (default is `password`)
- Change the password for the user account (default is `password`)
- Allow people to access the Camera Control screen without logging on (Allow Guest Access) – by default, guest access is permitted
- Set whether inactive sessions log off automatically or not – by default, inactive sessions expire after 30 minutes

Note

For best security, Vaddio strongly recommends changing the user and admin passwords. Using the default passwords leaves the product vulnerable to tampering.



Web Tasks for Administrators: Adding Room Information to the Screen

ROOM LABELS PAGE

Enter your organization's name, the conference room name and phone number, and the number for people to call for in-house A/V support. This information is displayed on every page of the web interface.



Web Tasks for Administrators: Configuring Network and Time/Date Settings

NETWORKING PAGE

Things you can do on this page:

- [Specify time zone and NTP server](#)
- Assign the camera's hostname
- Specify DHCP or static IP address
- Set up other networking information (if using static IP addressing)

Network Configuration

You will be able to enter the IP address, subnet mask, and gateway only if you set IP Address to Static.

Note

DHCP is the default setting, but the camera will use the default address of 169.254.1.1 if no DHCP server is available.

The screenshot displays the vaddio ConferenceSHOT AV web interface. The top header shows the logo and the device name: "Sirius Cybernetics Corporation, Conference Room 714". Below the header is a navigation menu with options: Camera Controls, Camera Settings, Audio, Control Devices, Streaming, Room Labels, Networking (highlighted), Security, Diagnostics, System, Help, and Logout.

The main content area is divided into two sections:

- DATE & TIME SETTINGS:**
 - Device System Time: Fri Dec 09 19:38 UTC 2016 (with a Refresh button)
 - Automatic NTP Updating: Enabled
 - Time Zone: Universal (dropdown menu)
 - NTP Server: pool.ntp.org
 - Buttons: Cancel, Save
- NETWORK CONFIGURATION:**
 - Hostname: vaddio-conferenceshot-av-D8-80-39-62-A7-C5
 - NETWORK INTERFACES:**
 - Ethernet Port (eth0:WAN):**
 - IP Address:
 - DHCP Static
 - MAC Address: D8:80:39:62:A7:C5
 - IP Address: 10.30.200.9
 - Subnet Mask: 255.255.255.0
 - Gateway: 10.30.200.254
 - Buttons: Cancel, Save

Specifying Time Zone and NTP Server

1. To make the time zone and NTP server editable, enable Automatic NTP Updating.
2. Select the desired time zone from the list.
3. If desired, specify the NTP server to use. If you are not sure about this, use the default.

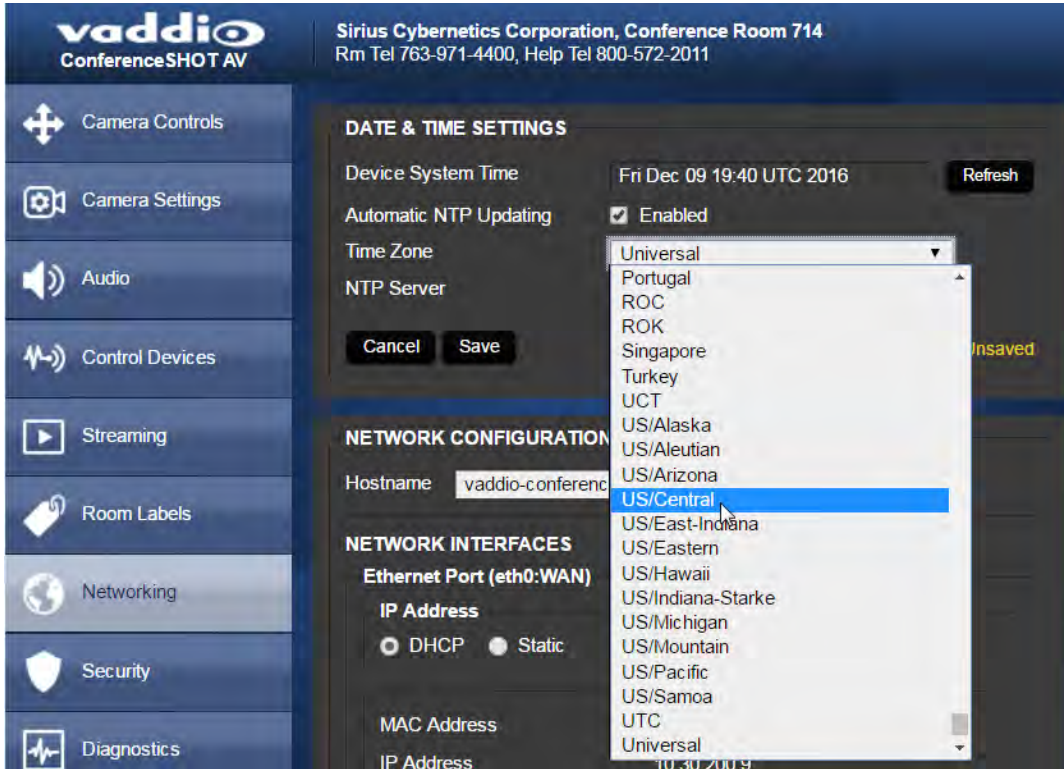

Web Tasks for Administrators: Configuring Streaming Settings

STREAMING PAGE

Things you can do on this page:

- Edit the [USB device name](#)
- Allow [soft client control](#) of the camera and audio
- [Enable/disable IP streaming and USB streaming](#) separately
- Set the [resolution, video quality, and frame rate](#) for IP streaming
- Specify the [IP streaming port and path/URL](#)

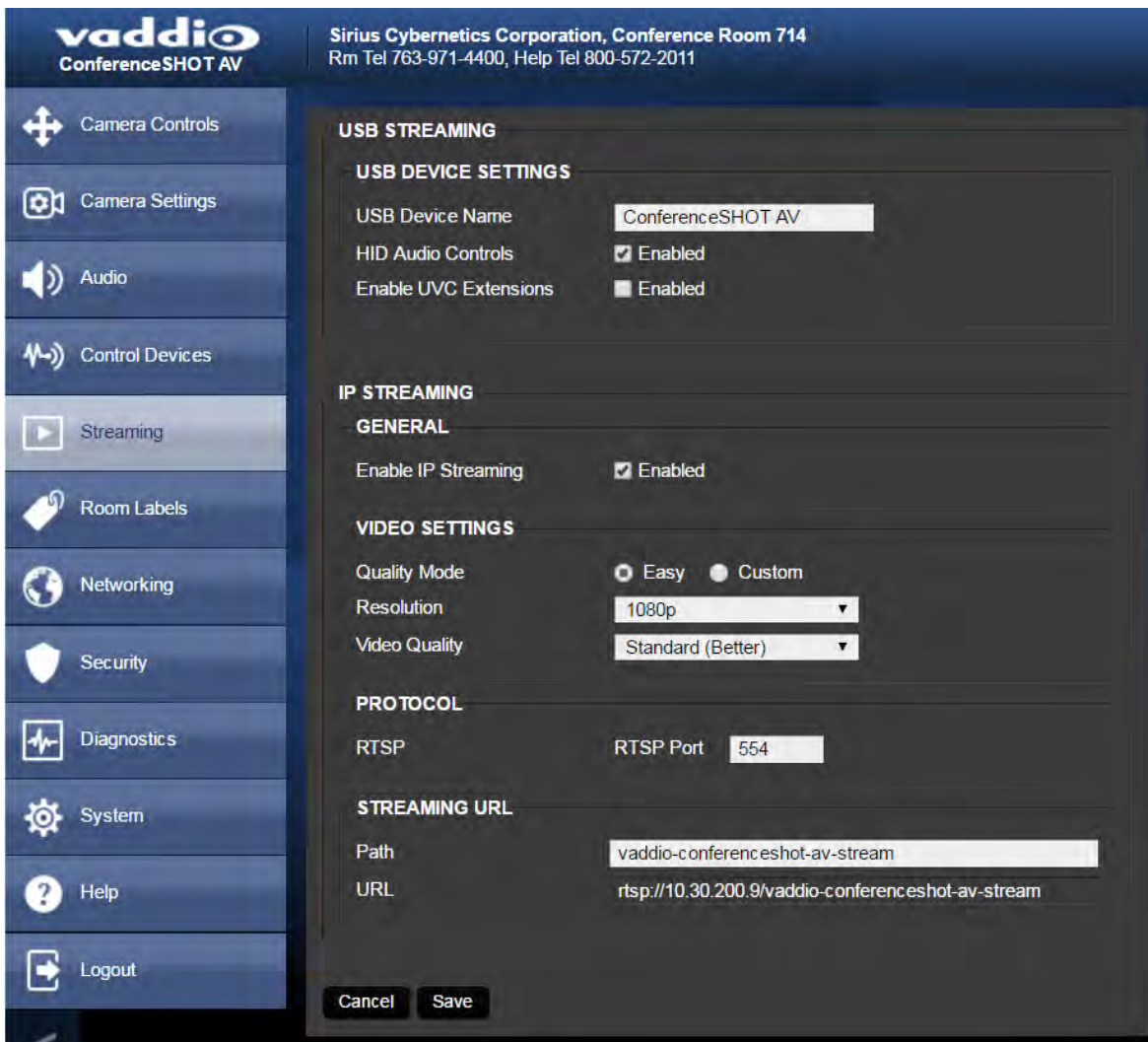

After making changes on this page, save them.

Edit the USB Device Name

To change the way the camera shows up in your soft client's camera selection list, edit the USB Device Name.

Allow Soft Client Control of the System

To allow conferencing applications to control the camera, check the Enabled box for Enable UVC Extensions.

To allow conferencing applications to control the audio, check the Enabled box for HID Audio Controls.

Enable or Disable Streaming

IP and USB streaming are enabled by default. Use the Enable USB Streaming and Enable IP Streaming checkboxes to change this.

Set IP Streaming Settings

If you are not sure about these settings, start with the defaults.

1. Select the video Quality Mode: Easy or Custom. Easy automatically sets the recommended frame rate; Custom provides additional control.
2. Select the desired IP streaming resolution.
3. Easy quality mode only: Select Video Quality.
4. Custom quality mode only: Select the desired IP streaming frame rate.
5. Custom quality mode only: Select Constant or Variable bit rate.
6. Custom quality mode, Variable bit rate only: Set the Quality (Quantization) slider.

VIDEO SETTINGS

Quality Mode Easy Custom

Resolution

Video Quality

VIDEO SETTINGS

Quality Mode Easy Custom

Resolution

Frame Rate fps

Bit Rate Constant Variable

Max Bandwidth

VIDEO SETTINGS

Quality Mode Easy Custom

Resolution

Frame Rate fps

Bit Rate Constant Variable

Quality (Quantization) Good Best

Note

USB streaming resolution and frame rate are automatically negotiated between the camera and the conferencing application.

Advanced IP Streaming Settings

RTSP port: Vaddio strongly recommends using the default RTSP port number unless you need to change it.

Streaming URL: Edit the path to change the portion of the streaming URL that appears after the IP address.

Web Tasks for Administrators: Color, Lighting, and Speed Adjustments

The Camera Settings page lets you do these things:

- [Set up the color settings](#) the camera uses.
- Set the [pan, tilt, and zoom speeds](#) that will be used.



Adjust the Color Settings

1. To allow the camera to compensate automatically for the light level, check the Auto Iris box. Leave it unchecked to adjust iris and gain manually.
2. Auto Iris adjustments – these adjust contrast between the brightest and darkest areas of the image.
 - If there is bright light behind the main subject of the shot, check the box for Back Light Compensation.
 - To increase contrast between the brightest and darkest areas, check the box for Wide Dynamic Range.

Because Backlight Compensation reduces the contrast between extremes and Wide Dynamic Range increases it, they cannot be used together.

3. To allow the camera to adjust the white balance automatically, check the Auto White Balance box. Leave it unchecked to adjust red gain and blue gain manually.
4. Detail – adjust the slider as required for the right image sharpness.

Note

If the video looks grainy or “noisy,” try a lower Detail setting.

5. Chroma – adjust the slider as needed for the right level of color intensity.
6. Gamma – adjust the slider as needed for the desired range between bright areas and shadows.

If you make a change that you don't like, start over by selecting and then deselecting Auto White Balance.

Set Pan, Tilt, and Zoom Speeds

In the Global Preset Speeds section, set the speeds for movements to presets.

Web Tasks for Administrators: Customizing the Audio

AUDIO PAGE

The web interface provides separate controls for each of the audio inputs (microphones 1 and 2, USB playback) and outputs (line out, IP stream, and USB record).

Controlling Volume

To manage individual audio inputs or outputs:

Use the slider for the appropriate audio input or output to set the volume. The audio read-out bar and numeric value can be helpful.

Note

For best performance with most computers, we recommend setting the USB Record volume high.

Use the button to mute the desired audio input or output.

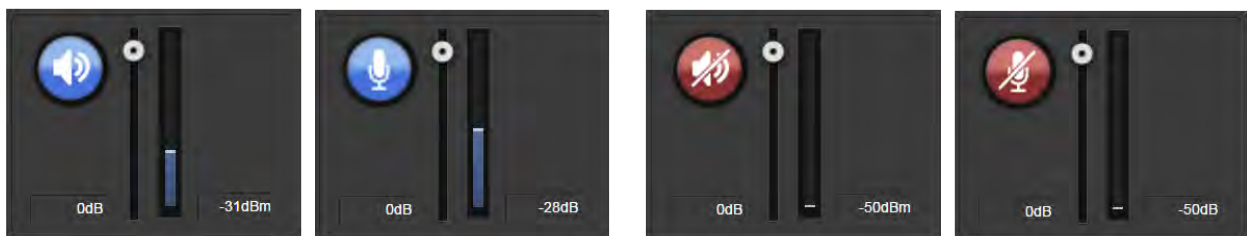

To control all audio inputs or outputs at once:

Use the Microphone and Speakers controls on the Camera Controls page.



Fine-Tuning

To adjust microphones for best far-end audio performance:

Check or clear the checkboxes for the desired adjustments:

- **Echo Cancellation** – Selected by default. Under most circumstances, echo cancellation is desirable.
- **Noise Cancellation** – Selected by default; suppresses ambient noise such as the conference room's heating/air conditioning.
- **Automatic Gain Control** – Selected by default; adjusts gain to compensate for differences in the volume of people's voices.
- **Mic Boost** – Provides a 3 dB boost.



To reduce the dynamic range from the connected speaker:

If some people on the far end are inaudible while others are too loud, check the Compressor box.

To adjust for more natural sound:

Use the equalizer to adjust specific frequency ranges.

To sync the sound with the video in the IP stream:

Check the Delay box and enter a delay value in msec.



Web Tasks for Administrators: Setting up Macros and Triggers

Macros define actions or sequences of actions. Triggers can specify a macro to execute when the trigger is activated, and a macro to execute when the trigger is turned off. The 10 software triggers are available via Telnet command, allowing you to program custom functions for third-party control devices. The two One Touch triggers allow you to define responses to Vaddio trigger devices such as StepVIEW mats.

Writing and Editing Macros

CONTROL DEVICES PAGE, MACROS TAB

To define a macro:

1. Enter a name in the Macro Editor's Name field.
2. Enter one or more Telnet commands in the editing area.
3. Optional: Use the Test button to check your work while you are writing the macro.
4. Save your work when you are finished, or select New to start over.

To edit or copy an existing macro:

Select the Edit button associated with the macro, make your changes in the Macro Editor, and save your work.

To create a macro that is similar to an existing one, edit the existing macro and use the Save As button. The system prompts you to name the new macro.

The screenshot displays the Vaddio ConferenceSHOT AV web interface. The top header includes the Vaddio logo and contact information for Sirius Cybernetics Corporation. A left sidebar contains navigation icons for Camera Controls, Camera Settings, Audio, Control Devices (selected), Streaming, Room Labels, Networking, Security, Diagnostics, System, Help, and Logout. The main content area is divided into two tabs: 'Macros' and 'Triggers'. The 'Macros' tab shows a table with two entries: 'Preset 1' and 'Preset 2', each with 'Test' and 'Edit' buttons. Below this is the 'MACRO EDITOR' section, which includes a 'Name' input field and a large text area for editing. At the bottom of the editor are buttons for 'Test', 'Save', 'Save As...', and 'New'. To the right is the 'MACRO EXECUTION LOG' section, which is currently empty. At the bottom of the interface, there is a 'TRIGGER STATUS' section with buttons for 'Software 1' through 'Software 10' and a 'Test Mode' toggle switch set to 'Off'.

Testing Macros

The Macro Editor has a Test button to run a macro while you are editing it. You can also test macros after saving them. The Macro Execution Log shows the result of each test.

Defining and Deleting Triggers

CONTROL DEVICES PAGE, TRIGGERS TAB

To define a trigger:

For the trigger you are defining,

- Optional: Select a macro in the Execute Macro on Enter field. This macro will start when the trigger turns on.
- Optional: Select a macro in the Execute Macro on Exit field. This macro will start when the trigger turns off.

Because triggers are typically invoked programmatically, you cannot rename them.

To delete a trigger:

Select the X on that trigger's row. This is equivalent to setting both macros to (none).

The screenshot shows the Vaddio ConferenceSHOT AV interface. The top header includes the Vaddio logo and contact information for Sirius Cybernetics Corporation. The left sidebar contains navigation icons for Camera Controls, Camera Settings, Audio, Control Devices (selected), Streaming, Room Labels, Networking, Security, Diagnostics, System, Help, and Logout. The main content area is titled 'TRIGGER EVENTS' and is divided into two tabs: 'Macros' and 'Triggers'. The 'Triggers' tab is active, displaying a table with the following data:

Trigger	Execute Macro On Enter	Execute Macro On Exit	
Software 1	(none)	(none)	X
Software 2	(none)	(none)	X
Software 3	(none)	(none)	X
Software 4	(none)	(none)	X
Software 5	(none)	(none)	X
Software 6	(none)	(none)	X
Software 7	(none)	(none)	X
Software 8	(none)	(none)	X
Software 9	(none)	(none)	X
Software 10	(none)	(none)	X
One Touch 1	Presets 1	(none)	X
One Touch 2	Presets 2	(none)	X

At the bottom of the interface, there is a 'TRIGGER STATUS' section with a 'Test Mode' toggle set to 'Off'.

Testing Triggers

CONTROL DEVICES PAGE

The Trigger Testing section is available from both tabs of the Control Devices page. Trigger indicators illuminate to show that the trigger is on.

To test a trigger:

1. Set Test Mode on.
2. Select the trigger to turn on.
3. Select the trigger again to turn it off.

Note

Turn off Test Mode when you are finished testing; otherwise, the triggers are not available to the control device. Diagnostic: If you send a `trigger` command via Telnet and the command returns an error message, check to see whether Test Mode is on.

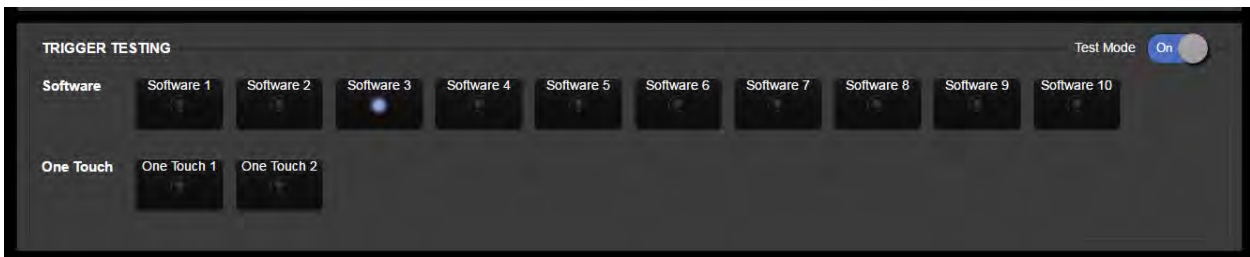

Web Tasks for Administrators: Reboots and Updates

The System page opens to the Firmware tab, where you can:

- Run a [firmware update](#)
- [Reboot](#) the camera
- Set the camera back to its [original factory settings](#)
- [Save the current configuration \(Export Data\)](#) or [restore a configuration \(Import Data\)](#)

The DIP Switches tab provides access to the soft DIP switches. The Peripherals tab enables you to update the firmware for the connected microphones.

Reboot the Camera

This can help if the camera stops responding as you expect. In the System Utilities section, click Reboot.

Save and Import or Restore a Configuration

If you need to configure several cameras the same way, you can configure the first one, export its configuration, and then import the configuration to the other cameras. The export downloads to your computer as a `.dat` file. The filename is the camera's hostname.

Note

The camera cannot import a `.dat` file that was exported from a camera using a different version of software.

Start a Firmware Update

The process to update microphone firmware is the same as for updating the camera.

1. Be sure you have downloaded the appropriate update file to your computer.
2. If you are updating microphone firmware, go to the Peripherals tab.



3. Click Choose File and select the update file.
4. Click Begin Firmware Update.
5. READ the information in the Confirm dialog box and be sure you understand it. It may seem boring, but it could save you some time and aggravation.
6. When you are ready to start the update, click Continue. A progress message box opens and the indicator light on the front of the camera turns yellow to show the firmware update is in progress. If the update process presents warnings or error messages, read them carefully.
The camera reboots when the update is complete.
7. Contact Vaddio technical support if you encounter any problems with the update.

Caution

Do not remove power or reset the camera while the indicator is yellow, showing a firmware update in progress. Interrupting a firmware update can make the camera unusable.

Camera Switch Settings

The DIP Switches tab of the System page provides access to these features:

Camera ID (IR Settings) – The IR Remote Commander can control up to three cameras in the same room with different IR frequencies. Use **IR Settings** switches 1 and 2 to select the frequency to identify the camera as camera 1, 2, or 3; then use the Camera Select buttons at the top of the remote to select the camera you want to control.

Image Flip – If mounting the camera upside-down, set IMAGE FLIP ON.

Note

Inverted installation is not recommended when the ConferenceSHOT speaker is to be used.

Super Wide mode – Provides a wider horizontal field of view and greater zoom. Some distortion may be present.

Status light color scheme (Pro AV or UCC) – Select the status light color scheme that meets your needs. The Pro AV color scheme matches the color scheme used in Vaddio's non-USB cameras.

USB stream format (UVC Compliant or Client Custom) – Client Custom enables far-end camera control when used with the Zoom soft client.

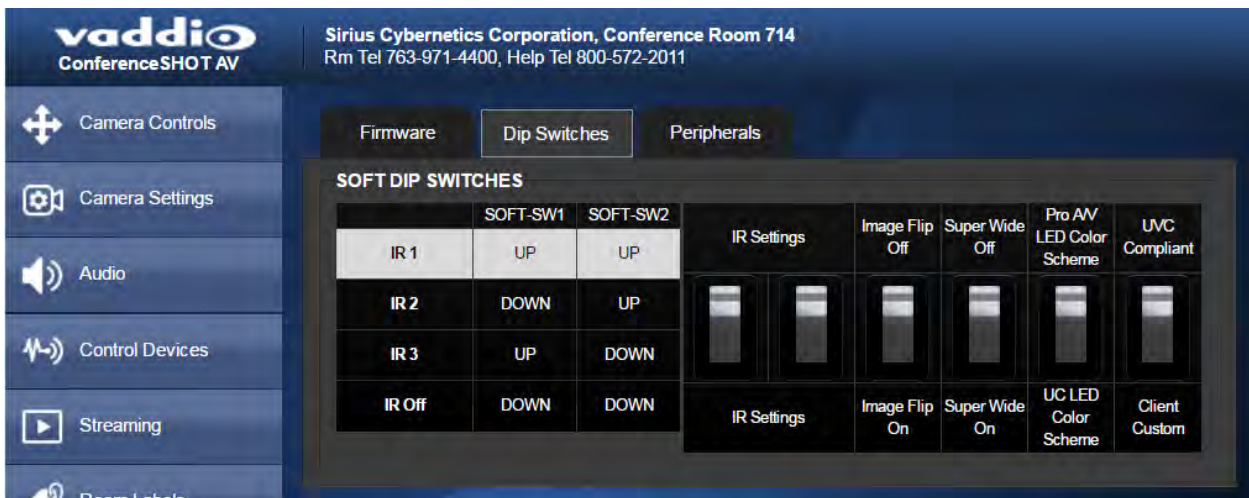

Web Tasks for Administrators: Contacting Vaddio Technical Support

If you can't resolve an issue using your troubleshooting skills (or the [Troubleshooting](#) table in this manual), we are here to help.

You'll find information for contacting Vaddio Technical Support on the Help screen.



The screenshot shows the Vaddio ConferenceSHOT AV interface. At the top left is the Vaddio logo and 'ConferenceSHOT AV'. To the right, it says 'Sirius Cybernetics Corporation, Conference Room 714' and 'Rm Tel 763-971-4400, Help Tel 800-572-2011'. A sidebar on the left contains navigation options: Camera Controls, Camera Settings, Audio, Control Devices, Streaming, and Room Labels. The main content area is titled 'TECHNICAL SUPPORT' and contains the following text:

You can reach Vaddio technical support by calling:

Direct:	+1 (763) 971-4428
Toll Free:	+1 (800) 572-2011
Fax:	+1 (763) 971-4464

Through email by sending your questions to:
support@vaddio.com

Or access support information directly on our web page at:
<http://help.vaddio.com/conferenceshot-av>

Web Tasks for Administrators: Viewing Diagnostic Logs

If you encounter a problem that you can't solve, your Vaddio technical support representative may ask you to download and email the log file available from the Diagnostics screen.

The screenshot shows the Vaddio ConferenceSHOT AV web interface. At the top, it displays the Vaddio logo and the text "Sirius Cybernetics Corporation, Conference Room 714" with contact information. A "Logout" button is in the top right. The left sidebar contains navigation icons for Camera Controls, Camera Settings, Audio, Control Devices, Streaming, Room Labels, Networking, Security, Diagnostics (highlighted), System, Help, and another Logout button. The main content area is titled "DIAGNOSTICS" and shows a scrollable log of system events. The log entries include timestamps and various system messages, such as "sdhci-pltfm: SDHCI platform and OF driver helper" and "EasyMic[1] uif: lost connection 1 bytearray(b'')". At the bottom of the log area, there are buttons for "Download", "Refresh", "Clear", and "Restore".

Telnet Serial Command API

The Vaddio Telnet command API allows an external device such as an AMX or Crestron presentation system to control the camera.

Note

When you connect via Telnet, you must log in using the admin account.

The command format follows a get/set structure. Here are some examples:

Command	<code>camera pan right</code>
Response	OK >
Command	<code>camera focus mode auto</code>
Response	OK >
Command	<code>camera ccu get iris</code>
Response	iris 6 OK >

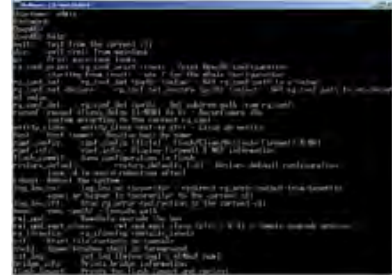

Use a question mark as a command parameter to bring up a list of commands, subcommands, or command parameters. For example:

> camera focus ?

```
near   Focus the camera near
far    Focus the camera far
stop   Stop the camera focus
mode   Camera focus mode
```

Things you might need to know about control via Telnet session:

- Command lines are terminated with a carriage return.
- All ASCII characters (including carriage returns) are echoed to the terminal program and appended with the VT100 string ESC[J (hex 1B 5B 4A), which most terminal programs automatically strip.
- CTRL-5 Clears the current serial buffer on the device.

camera home

Moves the camera to its home position.

Synopsis	camera home
Example	>camera home OK >

camera pan

Moves the camera horizontally

Synopsis	camera pan { left [<speed>] right [<speed>] stop }	
Options	left	Moves the camera left.
	right	Moves the camera right.
	speed [1 - 24]	Optional: Specifies the pan speed as an integer (1 to 24). Default speed is 12.
	stop	Stops the camera's horizontal movement.
Examples	<pre>>camera pan left OK ></pre> <p>Pans the camera left at the default speed.</p> <pre>>camera pan right 20 OK ></pre> <p>Pans the camera right using a speed of 20.</p> <pre>>camera pan stop OK ></pre> <p>Stops the camera's horizontal motion.</p>	

camera tilt

Moves the camera vertically.

Synopsis	camera tilt{ up [<speed>] down [<speed>] stop }	
Options	up	Moves the camera up.
	down	Moves the camera down.
	speed [1 - 20]	Optional: Specifies the tilt speed as an integer (1 to 20). Default speed is 10.
	stop	Stops the camera's vertical movement.
Examples	<pre>>camera tilt up OK > Tilts the camera up at the default speed. >camera tilt down 20 OK > Tilts the camera down using a speed of 20. >camera tilt stop OK > Stops the camera's vertical motion,</pre>	

camera zoom

Moves the camera in toward the subject or out away from the subject.

Synopsis	camera zoom { in [<speed>] out [<speed>] stop }	
Options	in	Moves the camera in.
	out	Moves the camera out.
	speed[1 - 7]	Optional: Specifies the zoom speed as an integer (1 to 7). Default speed is 3.
	stop	Stops the camera's zoom movement.
Examples	<pre>>camera zoom in OK > Zooms the camera in at the default speed. >camera zoom out 7 OK > Zooms the camera out using a speed of 7. >camera zoom stop OK > Stops the camera's zoom motion.</pre>	

camera focus

Changes the camera focus.

Synopsis	<code>camera focus {{ near [<speed>] far [<speed> stop]} {mode [get auto manual]}}</code>	
Options	<code>near</code>	Brings the focus nearer to the camera. Can only be used when camera is in manual mode.
	<code>far</code>	Moves the focus farther from the camera. Can only be used when camera is in manual mode.
	<code>speed [1 - 8]</code>	Optional: integer (1 to 8) specifies the focus speed.
	<code>mode [get auto manual]</code>	Returns the current focus mode, or specifies automatic or manual focus.
	<code>stop</code>	Stops the camera's focus movement.
Examples	 <pre> camera focus near OK > Brings the focus near at the default speed. camera focus far 7 OK > Moves the focus farther from the camera at a speed of 7. camera focus mode get auto_focus: on OK > Returns the current focus mode. </pre>	

camera preset

Moves the camera to the specified preset, or stores the current camera position and optionally CCU information.

Synopsis	<code>camera preset { recall store} [1 - 16] [save-ccu]</code>	
Options	<code>recall [1 - 16]</code>	Moves the camera to the specified preset.
	<code>store [1 - 16]</code>	Stores the current camera position as the specified preset.
Examples	<pre> >camera preset recall 3 OK > Moves the camera to preset 3. >camera preset store 1 OK > Saves the camera's current position as preset 1. </pre>	

camera ccu get

Returns or sets CCU (lighting) information.

Synopsis	<code>camera ccu get [param]</code>	
	<code>auto_white_balance</code>	Returns the current state of the auto white balance setting (on or off).
	<code>red_gain</code>	Returns the red gain value as an integer (0 to 255).
	<code>blue_gain</code>	Returns the blue gain value as an integer (0 to 255).
	<code>backlight_compensation</code>	Returns the current state of the backlight compensation setting (on or off).
	<code>iris</code>	Returns the iris value as an integer (0 to 11).
	<code>auto_iris</code>	Returns the current auto-iris state (on or off).
	<code>gain</code>	Returns the gain value as an integer (0 to 11).
	<code>detail</code>	Returns the detail value as an integer (0 to 15).
	<code>chroma</code>	Returns the chroma value as an integer (0 to 14).
	<code>wide_dynamic_range</code>	Returns the current setting for Wide Dynamic Range (on or off).
<code>all</code>	Returns all current CCU settings.	
Examples	<pre>>camera ccu get iris iris 6 OK > Returns the current iris value. >camera ccu get red_gain red_gain 201 OK > Returns the current red gain value. >camera ccu get all auto_iris on auto_white_balance on backlight_compensation off blue_gain 193 chroma 2 detail 8 gain 3 iris 11 red_gain 201 wide_dynamic_range off OK > Returns all current CCU settings.</pre>	

camera ccu set

Sets the specified CCU (lighting) information.

Synopsis	camera ccu set [param] [value]	
Options 	auto_white_balance {on off}	Sets the current state of the auto white balance setting (on or off). Auto white balance overrides red gain and blue gain manual settings.
	red_gain [0 - 255]	Sets the red gain value as an integer (0 to 255). Can only be used when auto white balance is off.
	blue_gain [0 - 255]	Sets the blue gain value as an integer (0 to 255). Can only be used when auto white balance is off.
	backlight_compensation {on off}	Sets the current state of the backlight compensation setting (on or off). Can only be used when wide dynamic range mode is off.
	iris [0 - 11]	Sets the iris value as an integer (0 to 11). Can only be used when auto-iris is off.
	auto_iris {on off}	Sets the auto-iris state (on or off). Auto-iris disables manual iris and gain when it is on.
	gain [0 - 11]	Sets gain value as an integer (0 to 11). Can only be used when auto-iris is off.
	detail [0 - 15]	Sets the detail value as an integer (0 to 15).
	chroma [0 - 14]	Sets the chroma value as an integer (0 to 14).
	wide_dynamic_range {on off}	Sets Wide Dynamic Range mode on or off. Can only be used when backlight compensation is off.
Examples	<pre>>camera ccu set auto_iris off OK > Turns off auto-iris mode, returning the camera to manual iris control. >camera ccu set red_gain 10 OK > Sets the red gain value to 10.</pre>	

camera recalibrate

Recalibrates the pan and tilt motors. This is typically done in response to a motor fault indication or error message.

Synopsis	camera recalibrate
Example	<pre>>camera recalibrate OK ></pre>

camera standby

Set or change camera standby status.

Synopsis	camera standby { get off on toggle }	
Options	get	Returns the camera's current standby state.
	off	Brings the camera out of standby (sleep) mode.
	on	Stops video and puts the camera in standby mode.
	toggle	Changes the camera's standby state - if it was not in standby mode, it enters standby; if it was in standby mode, it "wakes up."
Examples	<pre>>camera standby off OK ></pre> <p>Brings the camera out of standby mode.</p> <pre>>camera standby get standby: on OK ></pre> <p>Returns the current standby state.</p>	

video mute

Gets or sets the camera's video mute status. When video is muted, the camera sends blue or black video with an on-screen message stating that video mute is on. This can be desirable when preparing the room or when privacy is needed.

Synopsis	video mute { get off on toggle }	
Options	get	Returns the current video mute status.
	off	Unmutes the video. (Normal video resumes.)
	on	Mutes the video. (Blue or black screen with message)
	toggle	Changes the camera's video mute status.
Examples	<pre>>video mute get mute: off OK ></pre> <p>Returns video mute status.</p> <pre>>video mute on OK ></pre> <p>Transmits blue or black video.</p>	

audio volume

Gets or sets the volume of the specified audio channel.

Synopsis	audio [channel] volume {get on off toggle}	
Channels	master	Applies the command to all audio channels.
	easy_mic_1	Applies the command to the microphone connected to the EasyMIC 1 port.
	easy_mic_2	Applies the command to the microphone connected to the EasyMIC 2 port.
	usb_playback	Applies the command to the USB playback line (input data).
	line_out_1	Applies the command to the device connected to the Audio Output port.
	usb_record	Applies the command to the USB record line (output data).
	ip_stream	Applies the command to the audio portion of the IP stream.
Options	get	Returns the current volume of the specified channel.
	up	Increases the volume of the specified channel.
	down	Reduces the volume of the specified channel.
	set	Sets the volume of the specified channel in dB.
Examples	<pre>audio easy_mic_1 volume set -5 OK ></pre> <p>Sets -5 dB as the volume for the microphone connected to the EasyMIC 1 port.</p> <pre>audio line_out_1 volume get volume -10.0 dB OK ></pre> <p>Returns the current volume for the speaker connected to the line out port.</p>	

audio mute

Gets or sets the mute status of the specified audio channel.

Synopsis	audio [channel] mute {get on off toggle}	
Channels	master	Applies the command to all audio channels.
	easy_mic_1	Applies the command to the microphone connected to the EasyMIC 1 port.
	easy_mic_2	Applies the command to the microphone connected to the EasyMIC 2 port.
	usb_playback	Applies the command to the USB playback line (input data).
	line_out_1	Applies the command to the device connected to the Audio Output port.
	usb_record	Applies the command to the USB record line (output data).
	ip_stream	Applies the command to the audio portion of the IP stream.
Options	get	Returns the current mute status of the specified channel.
	on	Mutes the audio for the specified channel.
	off	Unmutes the audio for the specified channel.
	toggle	Changes the mute state for the specified channel – unmutes if it was muted, mutes if it was not.
Examples	<pre>> audio easy_mic_1 mute get mute: off OK ></pre> <p>Returns the current mute state of the microphone connected to the EasyMIC 1 port. Mute is off, so the microphone is live.</p> <pre>>audio line_out_1 mute on OK ></pre> <p>Mutes the speaker connected to the line out port.</p>	

trigger

Turn an existing trigger on or off. This command has no effect if the specified trigger has not been defined.

Note

If the web interface's macro/trigger test mode is in use, this command may return parse errors.

Synopsis	trigger <1..10> {off on}	
Parameters	<1..10>	The trigger index (identifier) – triggers 1 through 10 are available.
	{off on}	Set the state of the trigger.
Example	<pre>> trigger 3 on OK Turns trigger 3 on.</pre>	

streaming settings get

Returns current IP and USB streaming settings.

Synopsis	<code>streaming settings get</code>	
Parameters	IP Custom_Frame_Rate	Frame rate selected in Custom quality mode.
	IP Custom_Resolution	Resolution selected in Custom quality mode.
	IP Enabled	Specifies whether IP streaming is enabled.
	IP Port	The RTSP port number used for IP streaming. Default is 554.
	IP Preset_Quality	Video quality selected in Easy video quality mode.
	IP Preset_Resolution	Resolution selected in Easy video quality mode.
	IP Protocol	The IP streaming protocol in use.
	IP URL	The URL where the stream is available.
	IP Video_Mode	Video quality mode selected (Easy or Custom).
	USB Active	True when a USB stream is present; false otherwise.
	USB Device	The USB Device Name currently assigned.
	USB Frame_Rate	Frame rate in use for USB streaming (negotiated with conferencing client). 0 when no USB stream is present.
	USB Resolution	Resolution of the USB stream (negotiated with conferencing client). 0x0 when no USB stream is present.
	USB Version	2 or 3, as negotiated with the conferencing client. 0 if no USB stream is present.
UVC Extensions_Enabled	Allow or disable soft client USB control of the camera.	
Example	<pre>>streaming settings get IP Custom_Frame_Rate 30 IP Custom_Resolution 1080p IP Enabled true IP Port 554 IP Preset_Quality Standard (Better) IP Preset_Resolution 1080p IP Protocol RTSP IP URL vaddio-conferenceshot-av-stream IP Video_Mode preset USB Active false USB Device ConferenceSHOT AV USB Frame_Rate 0 USB Resolution 0x0 USB Version 3 UVC Extensions_Enabled false OK ></pre>	

network settings get

Returns the camera's current network settings and MAC address.

Synopsis	<code>network settings get</code>
Example	<pre>network settings get Name eth0:WAN MAC Address 00:1E:C0:F6:CA:7B IP Address 192.168.1.67 Netmask 255.255.255.0 VLAN Disabled Gateway 192.168.1.254 OK ></pre>

network ping

Sends an ICMP ECHO_REQUEST to the specified IP address.

Synopsis	<code>network ping [count <count>] [size <size>] <destination-ip></code>	
Options	<count>	The number of ECHO_REQUEST packets to send. Default is five packets.
	<size>	The size of each ECHO_REQUEST packet. Default is 56 bytes.
	<destination-ip>	The IP address where the ECHO_REQUEST packets will be sent.
Examples	<pre>>network ping 192.168.1.66 PING 192.168.1.66 (192.168.1.66): 56 data bytes 64 bytes from 192.168.1.66: seq=0 ttl=64 time=0.476 ms 64 bytes from 192.168.1.66: seq=1 ttl=64 time=0.416 ms 64 bytes from 192.168.1.66: seq=2 ttl=64 time=0.410 ms 64 bytes from 192.168.1.66: seq=3 ttl=64 time=0.410 ms 64 bytes from 192.168.1.66: seq=4 ttl=64 time=3.112 ms --- 192.168.1.66 ping statistics --- 5 packets transmitted, 5 packets received, 0% packet loss round-trip min/avg/max = 0.410/0.964/3.112 ms ></pre> <p>Sends five ECHO_REQUEST packets of 56 bytes each to the host at 192.168.1.66.</p>	
	<pre>>network ping count 10 size 100 192.168.1.1</pre> <p>Sends 10 ECHO_REQUEST packets of 100 bytes each to the host at 192.168.1.1. The command returns data in the same form as above.</p>	

sleep

Pauses command execution for the specified number of milliseconds.

Synopsis	sleep <milliseconds>	
Options	<milliseconds>	The number of milliseconds (1 to 10000) to pause.
Example	<pre>>sleep 7000 OK ></pre> <p>Pause for 7 seconds (7000 milliseconds) before returning.</p>	

system reboot

Reboots the system either immediately or after the specified delay. Note that a reboot is required when resetting the system to factory defaults (system factory-reset).

Synopsis	system reboot [<seconds>]	
Options	<seconds>	The number of seconds to delay the reboot.
Examples	<pre>>system reboot OK ></pre> <p>The system is going down for reboot NOW!conferenceshot-av-D8-80-39-62-A7-C5</p> <p>Reboots the system immediately.</p> <pre>>system reboot 30</pre> <p>Reboots the system in 30 seconds. The response is in the same form; the system message appears at the end of the delay.</p>	

system factory-reset

Gets or sets the factory reset status. When the factory reset status is on, the system resets to factory defaults on reboot.

Synopsis	<code>system factory-reset { get on off }</code>	
Options	<code>get</code>	Returns the camera's current factory reset status.
	<code>on</code>	Enables factory reset on reboot.
	<code>off</code>	Disables factory reset on reboot.
Examples 	<pre>>system factory-reset get factory-reset (software): off factory-reset (hardware): off OK ></pre> <p>Returns the factory reset status. This evaluates the most recent <code>system factory-reset on</code> or <code>off</code> command, if one has been received.</p> <pre>>system factory-reset on factory-reset (software): on factory-reset (hardware): off OK ></pre> <p>Enables factory reset upon reboot.</p> <p>Note <i>This command does not initiate a factory reset. The factory reset takes place on the next reboot.</i></p>	

version

Returns the current firmware version.

Synopsis	<code>version</code>
Example	<pre>>version Audio 1.03 Commit 598672663c7763ca45a02a6c8755f641068af509 PScC Version 1.4 Sensor Version 04.00 System Version ConferenceSHOT AV 1.0.0 OK ></pre>

history

Returns the most recently issued commands from the current Telnet session. Since many of the programs read user input a line at a time, the command history is used to keep track of these lines and recall historic information.

Synopsis	history <limit>	
Options	<limit>	Integer value specifying the maximum number of commands to return.
Examples	history Displays the current command buffer. history 5 Sets the history command buffer to remember the last 5 unique entries.	
Additional information	You can navigate the command history using the up and down arrow keys. This command supports the expansion functionality from which previous commands can be recalled from within a single session. History expansion is performed immediately after a complete line is read. Examples of history expansion: <ul style="list-style-type: none"> * !! Substitute the last command line. * !4 Substitute the 4th command line (absolute as per 'history' command) * !-3 Substitute the command line entered 3 lines before (relative) 	

help

Displays an overview of the CLI syntax.

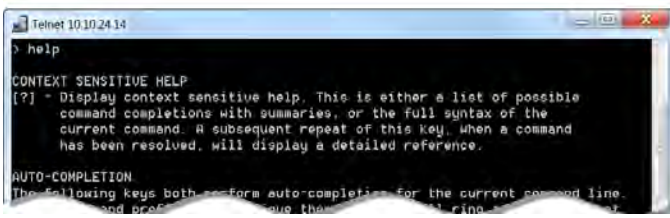
Synopsis	help	
Example		

exit

Ends the command session and closes the socket.

Synopsis	exit
Example	exit

Specifications

Camera and Image

Image device	1/2.8-type Exmor CMOS sensor	Pixels	2.14 million (effective)
IP (H.264) RTSP Video Resolutions	1080p down to 180p 1080p at 30/25/15; others 60/30/25/15	USB 3.0 (UVC) Video Resolutions	1080p down to 180p at 60/30/15
<i>IP and USB streams are simultaneous and can be at differing resolutions.</i>			
Pan angle and speed	± 165°, up to 90°/sec	Tilt angle and speed	+90° -30°, up to 90°/sec
Lens and horizontal FOV	10X optical zoom, 67.0° wide to 7.6° tele, f=3.8mm to 38mm, F1.8 to F3.4 Super-wide: 11X optical zoom, 74° wide to 7.6° tele, f=3.8mm to 41.8mm, F1.8 to F3.4		
Min. working distance	10mm (wide), 1.0m (tele)	Min. illumination	100+ lux recommended
Aperture/detail	16 steps	Gain	Auto or manual
Backlight compensation	On or off	White balance	Auto, manual, One-Push
Focusing system	Auto or manual	Noise reduction	On or off
Sync system	Internal	S/N ratio	Over 50 dB
Remote management	Web interface, Telnet	Power	PoE+ (25 watts)

Audio

EasyMIC Inputs (2 channels available)	RJ-45 12V, bidirectional, balanced	Line Out	4-pin Phoenix type terminal block Impedance: 50 ohms Frequency response 20Hz - 20KHz THD + noise < 0.02% Maximum output level +12 dBu differential audio Power to speaker: 12V, 0.84A max (10 watt speaker)
IP Streaming	1 Channel (PCM), 16-bit resolution, 48 KHz sample rate		
USB streaming (record, playback)	2 Channel (UAC), 16-bit resolution, 48 KHz sample rate		

Physical and Environmental

Height	Camera: 6.3" (163 mm) Speaker: 3.63" (92 mm)	Operating temperature	0°C to +40°C (32°F to 104°F)
Width	Camera: 6.1" (155 mm) Speaker: 7.25" (184 mm)	Operating humidity (relative)	20% to 80% non-condensing
Depth	Camera: 5.5" (145 mm) Speaker: 6.75" (171 mm)	Storage temperature	-5°C to +60° C (23°F to 140°F)
Weight	Camera: 3.0 lbs.(1.36 kg) Speaker: 1.6 lbs. (0.72 kg)	Storage humidity (relative)	20% to 80% non-condensing

Specifications are subject to change without notice.

Troubleshooting and Care

When the camera doesn't behave as you expect, check the indicator light on the front before you do anything else.

Use this table to determine whether it's time to call Vaddio Technical Support.

What is it doing?	Possible causes	Check and correct
Nothing. The light on the front is off.	At least one of the cables is bad.	Check using known good cables.
	The wall outlet is not active. (Check by finding out if it powers something else, such as a laptop or phone charger.)	Use a different outlet.
	The camera or its power supply is bad.	Contact your reseller or Vaddio Technical Support.
The camera is not responding to the remote and the light is yellow.	A firmware update is in progress.	Wait a few minutes, and try again when the light turns blue.
The camera does not respond to the remote, but the web interface is available	The remote is not using the same IR channel as the camera.	Push the Camera Select 1 button on the remote.
	The batteries in the remote are dead.	Put new batteries in the remote.
The camera responds to the remote but the web interface is not available.	The camera is not using the IP address you browsed to.	Press the Data Screen button on the remote to see camera information.
No H.264 video stream.	IP streaming is not enabled.	Enable IP streaming: Streaming page in the web interface.
No USB video stream.	USB streaming is not enabled.	Enable USB streaming: Streaming page in the web interface.
Status light continues to blink blue.	The USB cable is not connected.	Connect the USB cable.
Status light blinks yellow	Pan or tilt motor is out of calibration	Reset the pan and tilt motors. See Correct a Motor Calibration Error.

Correct a Motor Calibration Error

If the web interface presents an error message about the motors, or if the camera's status light is blinking yellow, you will need to reset the pan and tilt motors.

1. On the Camera Controls page, select Settings to open the pan and tilt settings box;
OR
On the System page, go to the Firmware tab if you are on a different tab.
2. Select Pan-Tilt Reset. The motors recalibrate. This takes a few seconds.

Status Light

The light in the camera's base indicates its current state.

- Blue – Camera is active
- Purple – Standby mode or booting
- Yellow – Firmware update is in progress
- Blinking blue – Video mute is on (Pro A/V color scheme) or USB cable is disconnected (UC color scheme)
- Blinking yellow – Motor out of calibration
- Blinking purple – Error

Caution

Do not remove power or reset the camera while the indicator is yellow, showing a firmware update in progress. Interrupting a firmware update can make the camera unusable.

Restoring Default Camera Settings

Factory reset clears most settings and returns soft DIP switches (on the DIP Switches tab of the System page) to their default positions.

Log on using the admin account, go to the System page's Firmware tab, and click Restore Factory Settings.

The screenshot displays the Vaddio ConferenceSHOT AV web interface. The top header includes the Vaddio logo and the text "Sirius Cybernetics Corporation, Conference Room 714" with contact information. A left sidebar contains navigation options: Camera Controls, Camera Settings, Audio, Control Devices, Streaming, Room Labels, Networking, Security, and Diagnostics. The main content area is titled "Firmware" and contains three tabs: Firmware, Dip Switches, and Peripherals. Under the "Firmware" tab, there are three sections: "SYSTEM INFORMATION" with fields for System Version (ConferenceSHOT AV 1.0.0), Commit (598672663c7763ca45a02a6c8755f641068af509), Audio (1.03), Sensor Version (04.00), and PSoC Version (–); "FIRMWARE UPDATE" with a "Firmware File:" field containing a "Choose File" button and "No file chosen" text, and a "Begin Firmware Update..." button; "SYSTEM UTILITIES" with buttons for "Reboot...", "Restore Factory Settings...", "Export Data", and "Import Data..."; and "CAMERA UTILITIES" with a "Pan-Tilt Reset" button.

Operation, Storage, and Care

For smears or smudges on the product, wipe with a clean, soft cloth. Use a lens cleaner on the lens. Do not use any abrasive chemicals.

Keep this device away from food and liquids.

Do not operate or store the device under any of the following conditions:

- Temperatures above 40°C (104°F) or below 0°C (32°F)
- High humidity, condensing or wet environments
- Inclement weather
- Severe vibration
- Between converging tectonic plates
- Dry environments with an excess of static discharge

Do not attempt to take this product apart. There are no user-serviceable components inside.

Compliance Statements and Declarations of Conformity

Compliance testing was performed to the following regulations:

FCC Part 15 (15.107, 15.109), Subpart B	Class A
ICES-003, Issue 54: 2012	Class A
EMC Directive 2004/108/EC	Class A
EN 55022: December 2010	Class A
EN 55024: November 2010	Class A
KN22 2008 (CISPR 22: 2006)	Class A
KN24 2008 (CISPR 24: 1997 + A1: 2000 + A2: 2002)	Class A
IEC 60950-1:2005 (2nd Edition); Am 1: 2009 + Am 2: 2013	Safety
EN 60950-1: 2006 + A11: 2009 + A1: 2010 + A12: 2011 + A2: 2013	Safety

FCC Part 15 Compliance

This equipment has been tested and found to comply with the limits for a Class A digital device, pursuant to Part 15, Subpart B, of the FCC Rules. These limits are designed to provide reasonable protection against harmful interference when the equipment is operated in a commercial environment. This equipment generates, uses, and can radiate radio frequency energy and, if not installed and used in accordance with the instruction manual, may cause harmful interference to radio communications. Operation of this equipment in a residential area is likely to cause harmful interference in which case the user will be required to correct the interference at his/her own expense.



Operation is subject to the following two conditions: (1) This device may not cause interference, and (2) This device must accept any interference including interference that may cause undesired operation of the device.

Changes or modifications not expressly approved by Vaddio can affect emission compliance and could void the user's authority to operate this equipment.

ICES-003 Compliance

This digital apparatus does not exceed the Class A limits for radio noise emissions from digital apparatus set out in the Radio Interference Regulations of the Canadian Department of Communications.

Le présent appareil numérique n'émet pas de bruits radioélectriques dépassant les limites applicables aux appareils numériques de la classe A prescrites dans le Règlement sur le brouillage radioélectrique édicté par le ministère des Communications du Canada.

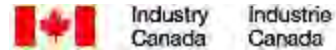

European Compliance

This product has been evaluated for electromagnetic compatibility under the EMC Directive for Emissions and Immunity and meets the requirements for a Class A digital device. In a domestic environment this product may cause radio interference in which case the user may be required to take adequate measures.

Standard(s) To Which Conformity Is Declared:



EMC Directive 2004/108/EC

EN 55022: December 2010

EN 55024: November 2010

EN 61000-4-2: 1995 + Amendments A1: 1998 + A2: 2001

EN 61000-4-3: 2006 + A1: 2008

EN 61000-4-4: 2004 + Corrigendum 2006

EN 61000-4-5: 2006

EN 61000-4-6: 2009

EN 61000-4-8: 2010

EN 61000-4-11: 2004

KN22 2008 (CISPR 22: 2006)

KN24 2008 (CISPR 24: 1997 + A1: 2000 + A2: 2002)

EN 61000-4-2

EN 61000-4-3

EN 61000-4-4

EN 61000-4-5

EN 61000-4-6

EN 61000-4-8

EN 61000-4-11

IEC 60950-1: 2005 (2nd Edition); Am 1: 2009 + Am 2: 2013

EN 60950-1: 2006 + A11: 2009 + A1: 2010 + A12: 2011 + A2: 2013

Conducted and Radiated Emissions

Immunity

Electrostatic Discharge

Radiated Immunity

Electrical Fast Transients

Surge Immunity

Conducted Immunity

Power Frequency Magnetic Field

Voltage Dips, Interrupts and Fluctuations

Conducted and Radiated Emissions

IT Immunity Characteristics

Electrostatic Discharge

Radiated Immunity

Electrical Fast Transients

Surge Immunity

Conducted Immunity

Power Frequency Magnetic Field

Voltage Dips, Interrupts and Fluctuations

Safety

Safety

Warranty Information

See Vaddio Warranty, Service and Return Policies posted on support.vaddio.com for complete details.

Hardware* warranty: Two (2) year limited warranty on all parts and labor for Vaddio manufactured products. Vaddio warrants its manufactured products against defects in materials and workmanship for a period of two years from the day of purchase, to the original purchaser, if Vaddio receives notice of such defects during the warranty. Vaddio, at its option, will repair or replace products that prove to be defective. Vaddio manufactures its hardware products from parts and components that are new or equivalent to new in accordance with industry standard practices.

Exclusions: The above warranty shall not apply to defects resulting from improper or inadequate maintenance by the customer, customers applied software or interfacing, unauthorized modifications or misuse, mishandling, operation outside the normal environmental specifications for the product, use of the incorrect power supply, modified power supply or improper site operation and maintenance. OEM and special order products manufactured by other companies are excluded and are covered by the manufacturer's warranty.

Vaddio Customer Service: Vaddio will test, repair, or replace the product or products without charge if the unit is under warranty. If the product is out of warranty, Vaddio will test then repair the product or products. The cost of parts and labor charge will be estimated by a technician and confirmed by the customer prior to repair. All components must be returned for testing as a complete unit. Vaddio will not accept responsibility for shipment after it has left the premises.

Vaddio Technical Support: Vaddio technicians will determine and discuss with the customer the criteria for repair costs and/or replacement. Vaddio Technical Support can be contacted by email at support@vaddio.com or by phone at one of the phone numbers listed on support.vaddio.com.

Return Material Authorization (RMA) number: Before returning a product for repair or replacement request an RMA from Vaddio's technical support. Provide the technician with a return phone number, e-mail address, shipping address, product serial numbers and original purchase order number. Describe the reason for repairs or returns as well as the date of purchase. See the General RMA Terms and Procedures section for more information. RMAs are valid for 30 days and will be issued to Vaddio dealers only. End users must return products through Vaddio dealers. Include the assigned RMA number in all correspondence with Vaddio. Write the assigned RMA number clearly on the shipping label of the box when returning the product. All products returned for credit are subject to a restocking charge without exception. Special order product are not returnable.

Voided warranty: The warranty does not apply if the original serial number has been removed or if the product has been disassembled or damaged through misuse, accident, modifications, use of incorrect power supply, use of a modified power supply or unauthorized repair.

Shipping and handling: Vaddio will not pay for inbound shipping transportation or insurance charges or accept any responsibility for laws and ordinances from inbound transit. Vaddio will pay for outbound shipping, transportation, and insurance charges for all items under warranty but will not assume responsibility for loss and/or damage by the outbound freight carrier. If the return shipment appears damaged, retain the original boxes and packing material for inspection by the carrier. Contact your carrier immediately.

Products not under warranty: Payment arrangements are required before outbound shipment for all out of warranty products.

Index

A

- admin login 14-15, 26
 - changing 26
 - default 14
- AGC (automatic gain control) 34
- anatomy of the camera 5
- anatomy of the system 5
- API 44, 58
 - syntax help 58
- audio 5-6, 12, 20-21, 33-34
 - connections 5-6
 - controls 33-34
 - delay 34
 - muting 12, 20-21
- Audio page (web) 33
- auto focus 24, 47
- auto iris 32, 49
- auto white balance 32, 49

B

- backing up a configuration 39
- backlight compensation 32, 48-49
- bandwidth 30
- behavior on power-up 11
- bit rate (IP streaming setting) 30
- blue gain 32, 49
- browser compatibility 14

C

- cable connectors 5-7
- calibration fault, correcting 60
- Camera Control page (web) 19
- camera ID setting (DIP switch) 41
- camera mount 7-8
 - installing 8
- camera placement 7
- camera select 12-13, See also camera ID setting (DIP switch)
- Camera Settings page (web) 32
- camera specifications 59
- camera standby position 21
- CCU settings 47-49
- cheat sheet 12-13, 17
 - Vaddio IR Remote Commander 12-13
 - web interface 17

- chroma setting 32, 49
- cleaning 62
- color codes for status light 11, 61
- color settings 32, 48-49
- command history 58
- compatibility, browsers 14
- configuration, saving or restoring 39
- connecting the speaker 10
- connection diagram 11
- connectors 5-6
- Constant Bit Rate 30
- Control Devices page (web) 36
- custom home position 23

D

- damage, preventing 2, 7
- default IP address 14
- default settings, restoring 61
- detail setting 32, 49
- DHCP 27
- diagnosing issues 60
- diagnostic logs 43
- Diagnostics page (web) 43
- diagram, connection 11
- DIP switches 41
 - soft 41
- directional controls 12-13, 22
- dynamic range 34

E

- echo cancellation 34
- equalizer 34
- Ethernet port 5

F

- factory defaults, restoring 57, 61
- fault isolation 60
- firmware update 40
- firmware version 57
- focus 12-13, 24, 47
- Frame Rate (IP streaming setting) 30

G

- gain 32
 - blue 32
 - red 32
- gamma setting 32
- getting help 42

guest access 15, 26
 allowing 26

H

help 42
 Help page (web) 42
 home position 22-23, 45
 custom 23
 hostname 27

I

image flip setting (DIP switch) 41
 importing a configuration 39
 inactive sessions (web interface) 26
 indicator light, meaning of colors 11, 61
 information, conference room 26
 installation 8-11
 basic connections 11
 camera 9
 camera mount 8
 speaker 10
 IP address 12-14, 27
 default 14, 27
 IP streaming 29-30, 54
 resolutions and frame rates 29
 settings 30, 54
 IR remote 12-13
 iris settings 48-49

L

labels, room 26
 light, status indicator 11, 61
 lighting settings 48-49
 location of the camera 7
 locations of connectors 5-6
 log files 43
 login 14-15
 admin 14-15
 user 14
 low-power state 21, 50

M

macros 36
 creating and editing 36
 testing 36
 manual focus 12-13, 24, 47
 Max Bandwidth (IP streaming setting) 30
 mic boost 34
 MicPOD ports 5

microphone 12, 20
 muting 12, 20
 motor calibration 60
 mount 7-8
 mounting the camera 7, 9
 mounting the speaker 10
 muting 12, 20-21, 33
 audio inputs and outputs 33
 microphones 12, 20
 speaker 21
 video 20

N

navigation buttons, hiding/showing 18
 network configuration 14, 27, 55
 current 55
 default 14, 27
 network port 5
 Networking page (web) 27
 noise cancellation 34
 NTP server 28

O

operating environment 7, 62

P

packing list 2
 page 19, 26-27, 29, 32-33, 36, 39, 42-43
 Audio 33
 Camera Control 19
 Camera Settings 32
 Control Devices 36
 Diagnostics 43
 Help 42
 Networking 27
 Room Labels 26
 Security 26
 Streaming 29
 System 39
 pan 25, 45
 direction 25
 pan/tilt recalibration 49, 60
 pan/tilt/zoom 12-13, 32
 pan/tilt/zoom controls 22
 part numbers 2
 passwords 26
 performance specifications 59
 physical and environmental specifications 59
 ping command 55

power connector 5
 power on/power off 11-13
 precautions 2, 7
 for operating the system 7
 presets 12-13, 22-23, 47
 clearing 13
 moving to 22, 47
 setting 13, 23, 47
 pro A/V status light color scheme 41
 product returns and repairs 65

Q

quick reference 12-13, 17
 Vaddio IR Remote Commander 12-13
 web interface 17

R

ready state 21, 50
 rebooting the camera 39, 56
 recalibration, pan and tilt 49, 60
 red gain 32, 49
 remote control 12-13
 requirements 7
 installation 7
 mounting 7
 reset pan and tilt motors 49
 resolution 29-30
 IP streaming 29-30
 USB streaming 29
 restoring a configuration 39
 restoring default settings 57, 61
 RJ-45 connectors 7
 room information 26
 Room Labels page (web) 26

S

saving a configuration 39
 Security page (web) 26
 settings, default, restoring 57, 61
 shelf, camera mount 8
 soft DIP switches 41
 software update 40
 solving problems 60
 speaker 10, 12, 21
 mounting and connecting 10
 muting 21
 volume, adjusting 12
 speaker port 5
 specifications 59

speed 24, 32, 45-47
 focus 47
 pan/tilt/zoom 24, 32, 45-46
 standby state 21, 50
 static IP address 27
 status light 11, 41, 61
 color scheme (DIP switch) 41
 meanings of colors 11, 61
 storage environment 62
 storing a configuration 39
 Streaming page (web) 29
 streaming settings 29, 54
 super-wide mode setting (DIP switch) 41
 supported web browsers 14
 switch settings 39, 41
 in web interface 41
 reading from web interface 39
 System page (web) 39

T

technical specifications 59
 technical support 42
 Telnet command help 58
 Telnet session 44, 58
 ending 58
 history 58
 temperature, operating and storage 62
 testing 36, 38
 macros 36
 triggers 38
 tilt 46
 time zone 28
 Tri-Synchronous Motion (Tri-Sync) 47
 trigger command, failure to execute 38
 trigger devices 36
 triggers 36-38, 53
 defining 37
 deleting 37
 testing 38
 troubleshooting 60

U

UC conferencing status light color scheme 41
 update 40
 USB port 5
 USB stream format (DIP switch) 41
 USB streaming 29
 user login 14, 26
 changing 26

default 14

V

Vaddio IR Remote Commander 12-13
Variable Bit Rate 30
version, firmware 57
video mute 20, 50
Video Quality (IP streaming setting) 30
virtual DIP switches 41
volume controls 12, 33

W

wall mount 8
 installing 8
warranty 7, 65
web browsers supported 14
web interface 18-19, 26-27, 29, 32-33, 36, 39,
 42-43
 Audio page 33
 Camera Control page 19
 Camera Settings page 32
 Control Devices page 36
 Diagnostics page 43
 Help page 42
 navigation button labels 18
 Networking page 27
 Room Labels page 26
 Security page 26
 Streaming page 29
 System page 39

Z

zoom 22, 46
zoom speed 12-13, 24, 46

Vaddio is a brand of Milestone AV Technologies · www.milestone.com

Phone 800.572.2011 / +1.763.971.4400 · Fax +1.763.971.4464 · Email info@vaddio.com

Visit us at support.vaddio.com for firmware updates, specifications, drawings, manuals, technical support information, and more.

Vaddio, ConferenceSHOT, RoboSHOT, and EasyUSB are trademarks or registered trademarks of Milestone AV Technologies. All other brand names or marks are used for identification purposes and are trademarks of their respective owners.

In British Columbia, Milestone AV Technologies ULC carries on business as MAVT Milestone AV Technologies ULC.

©2017 Milestone AV Technologies

vaddio®